

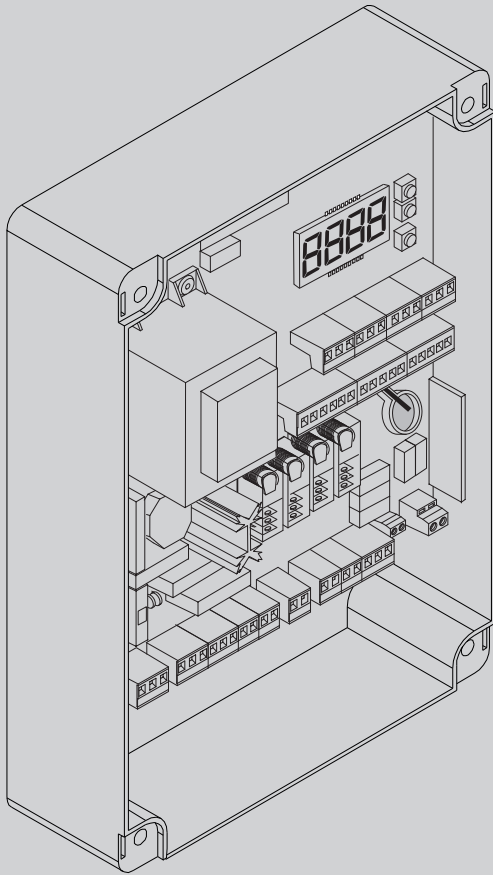

Ultra

D812865 00100\_04 23-12-16

CENTRALINA UNIVERSALE PER IL CONTROLLO DI UNO O DUE MOTORI  
UNIVERSAL CONTROL UNIT FOR ONE OR TWO MOTORS  
CENTRALE UNIVERSELLE PERMETTANT DE CONTRÔLER UN OU DEUX MOTEUR  
UNIVERSAL-STEUERGERÄT ZUR STEUERUNG VON EINEM ODER ZWEI MOTOREN  
CENTRALITA UNIVERSAL PARA CONTROLAR UNO O DOS MOTORES  
UNIVERSELE BESTURINGSEENHEID VOOR DE BESTURING VAN 1 OF 2 MOTOREN



ISTRUZIONI DI INSTALLAZIONE  
INSTALLATION MANUAL  
INSTRUCTIONS D'INSTALLATION  
MONTAGEANLEITUNG  
INSTRUCCIONES DE INSTALACION  
INSTALLATIEVOORSCHRIFTEN

# RIGEL 6



AZIENDA CON SISTEMA DI GESTIONE  
INTEGRATO CERTIFICATO DA DNV  
= UNI EN ISO 9001:2008 =  
UNI EN ISO 14001:2004

**Attenzione!** Leggere attentamente le "Avvertenze" all'interno! **Caution!** Read "Warnings" inside carefully! **Attention!** Veuillez lire attentivement les Avertissements qui se trouvent à l'intérieur! **Achtung!** Bitte lesen Sie aufmerksam die "Hinweise" im Inneren! **¡Atención!** Leer atentamente las "Advertencias" en el interior! **Let op!** Lees de "Waarschuwingen" aan de binnenkant zorgvuldig!

## AVVERTENZE PER L'UTILIZZATORE ( I )

**ATTENZIONE! Importanti istruzioni di sicurezza. Leggere e seguire attentamente le Avvertenze e le Istruzioni che accompagnano il prodotto poiché un uso improprio può causare danni a persone, animali o cose. Conservare le istruzioni per consultazioni future e trasmetterle ad eventuali subentranti nell'uso dell'impianto.**

**Questo prodotto dovrà essere destinato solo all'uso per il quale è stato espressamente installato. Ogni altro uso è da considerarsi improprio e quindi pericoloso. Il costruttore non può essere considerato responsabile per eventuali danni causati da usi impropri, erronei e irragionevoli.**

### SICUREZZA GENERALE

Nel ringraziarVi per la preferenza accordata a questo prodotto, la Ditta è certa che da esso otterrete le prestazioni necessarie al Vostro uso.

Questo prodotto risponde alle norme riconosciute della tecnica e della disposizioni relative alla sicurezza se correttamente installato da personale qualificato ed esperto (installatore professionale). L'automazione, se installata ed utilizzata correttamente, soddisfa gli standard di sicurezza nell'uso. Tuttavia è opportuno osservare alcune regole di comportamento per evitare inconvenienti accidentali:

- Tenere bambini, persone e cose fuori dal raggio d'azione dell'automazione, in particolare durante il movimento.
- Non permettere a bambini di giocare o sostare nel raggio di azione dell'automazione.
- L'apparecchio può essere utilizzato da bambini di età non inferiore a 8 anni e da persone con ridotte capacità fisiche, sensoriali o mentali, o prive di esperienza o della necessaria conoscenza, purché sotto sorveglianza oppure dopo che le stesse abbiano ricevuto istruzioni relative all'uso sicuro dell'apparecchio e alla comprensione dei pericoli ad esso inerenti. I bambini non devono giocare con l'apparecchio. La pulizia e la manutenzione destinata ad essere effettuata dall'utilizzatore non deve essere effettuata da bambini senza sorveglianza.
- I bambini devono essere sorvegliati per sincerarsi che non giochino con l'apparecchio. Non permettere ai bambini di giocare con i controlli fissi. Tenere i telecomandi lontani dai bambini.
- Evitare di operare in prossimità delle cerniere o organi meccanici in movimento.
- Non contrastare il movimento dell'anta e non tentare di aprire manualmente la porta se non è stato sbloccato l'attuatore con l'apposito sblocco.
- Non entrare nel raggio di azione della porta o cancello motorizzati durante il loro movimento.
- Non lasciare radiocomandi o altri dispositivi di comando alla portata dei bambini onde evitare azionamenti involontari.
- L'attivazione dello sblocco manuale potrebbe causare movimenti incontrollati della porta se in presenza di guasti meccanici o di condizioni di squilibrio.
- In caso di apertapparelle: sorvegliare la tapparella in movimento e tenere lontano le persone finché non è completamente chiusa. Porre cura quando si aziona lo sblocco se presente, poiché una tapparella aperta potrebbe cadere rapidamente in presenza di usura o rotture.
- La rottura o l'usura di organi meccanici della porta (parte guidata), quali ad esempio cavi, molle, sup-

porti, cardini, guide.. potrebbe generare pericoli. Far controllare periodicamente l'impianto da personale qualificato ed esperto (installatore professionale) secondo quanto indicato dall'installatore o dal costruttore della porta.

- Per ogni operazione di pulizia esterna, togliere l'alimentazione di rete.
- Tenere pulite le ottiche delle fotocellule ed i dispositivi di segnalazione luminosa. Controllare che rami ed arbusti non disturbino i dispositivi di sicurezza.
- Non utilizzare l'automatismo se necessita di interventi di riparazione. In caso di guasto o di malfunzionamento dell'automazione, togliere l'alimentazione di rete sull'automazione, astenersi da qualsiasi tentativo di riparazione o intervento diretto e rivolgersi solo a personale qualificato ed esperto (installatore professionale) per la necessaria riparazione o manutenzione. Per consentire l'accesso, attivare lo sblocco di emergenza (se presente).
- Per qualsiasi intervento diretto sull'automazione o sull'impianto non previsto dal presente manuale, avvalersi di personale qualificato ed esperto (installatore professionale).
- Con frequenza almeno annuale far verificare l'integrità e il corretto funzionamento dell'automazione da personale qualificato ed esperto (installatore professionale), in particolare di tutti i dispositivi di sicurezza.
- Gli interventi d'installazione, manutenzione e riparazione devono essere documentati e la relativa documentazione tenuta a disposizione dell'utilizzatore.
- Il mancato rispetto di quanto sopra può creare situazioni di pericolo.



### DEMOLIZIONE

L'eliminazione dei materiali va fatta rispettando le norme vigenti. Non gettate il vostro apparecchio scartato, le pile o le batterie usate nei rifiuti domestici. Avete la responsabilità di restituire tutti i vostri rifiuti da apparecchiature elettriche o elettroniche lasciandoli in un punto di raccolta dedicato al loro riciclo.

**Tutto quello che non è espressamente previsto nel manuale d'uso, non è permesso. Il buon funzionamento dell'operatore è garantito solo se vengono rispettate le prescrizioni riportate in questo manuale. La Ditta non risponde dei danni causati dall'inosservanza delle indicazioni riportate in questo manuale.**

**Lasciando inalterate le caratteristiche essenziali del prodotto, la Ditta si riserva di apportare in qualunque momento le modifiche che essa ritiene convenienti per migliorare tecnicamente, costruttivamente e commercialmente il prodotto, senza impegnarsi ad aggiornare la presente pubblicazione.**

## USER WARNINGS (GB)

**WARNING! Important safety instructions. Carefully read and comply with the Warnings and Instructions that come with the product as improper use can cause injury to people and animals and damage to property. Keep the instructions for future reference and hand them on to any new users.**

**This product is meant to be used only for the purpose for which it was explicitly installed.**



**Any other use constitutes improper use and, consequently, is hazardous. The manufacturer cannot be held liable for any damage as a result of improper, incorrect or unreasonable use.**

### GENERAL SAFETY

Thank you for choosing this product. The Firm is confident that its performance will meet your operating needs.

This product meets recognized technical standards and complies with safety provisions when installed correctly by qualified, expert personnel (professional installer).

If installed and used correctly, the automated system will meet operating safety standards. Nonetheless, it is advisable to observe certain rules of behaviour so that accidental problems can be avoided:

- Keep adults, children and property out of range of the automated system, especially while it is moving.
- Do not allow children to play or stand within range of the automated system.
- The unit can be used by children over 8 years old and by people with reduced physical, sensory or mental capabilities or with no experience or necessary knowledge on condition they are supervised or trained about the safe use of the equipment and understand the risks involved. Children must not play with the unit. Cleaning and maintenance must not be performed by unsupervised children.
- Children must be supervised to ensure they do not play with the device. Do not allow children to play with the fixed controls. Keep remote controls out of reach of children.
- Do not work near hinges or moving mechanical parts.
- Do not hinder the leaf's movement and do not attempt to open the door manually unless the actuator has been released with the relevant release knob.
- Keep out of range of the motorized door or gate while they are moving.
- Keep remote controls or other control devices out of reach of children in order to avoid the automated system being operated inadvertently.
- The manual release's activation could result in uncontrolled door movements if there are mechanical faults or loss of balance.
- When using roller shutter openers: keep an eye on the roller shutter while it is moving and keep people away until it has closed completely. Exercise care when activating the release, if such a device is fitted, as an open shutter could drop quickly in the event of wear or breakage.
- The breakage or wear of any mechanical parts of the door (operated part), such as cables, springs, supports, hinges, guides. . . , may generate a hazard. Have the system checked by qualified, expert personnel (professional installer) at regular intervals according to the instructions issued by the installer or manufacturer of the door.
- When cleaning the outside, always cut off mains power.
- Keep the photocells' optics and illuminating indicator devices clean. Check that no branches or shrubs interfere with the safety devices.
- Do not use the automated system if it is in need of repair. In the event the automated system breaks down or malfunctions, cut off mains power to the system; do not attempt to repair or perform any other work to rectify the fault yourself and instead call in qualified, expert personnel (professional installer) to perform the necessary repairs or main-

tenance. To allow access, activate the emergency release (where fitted).

- If any part of the automated system requires direct work of any kind that is not contemplated herein, employ the services of qualified, expert personnel (professional installer).
- At least once a year, have the automated system, and especially all safety devices, checked by qualified, expert personnel (professional installer) to make sure that it is undamaged and working properly.
- A record must be made of any installation, maintenance and repair work and the relevant documentation kept and made available to the user on request.
- Failure to comply with the above may result in hazardous situations.



### SCRAPPING

Materials must be disposed of in accordance with the regulations in force. Do not throw away your discarded equipment or used batteries with household waste. You are responsible for taking all your waste electrical and electronic equipment to a suitable recycling centre.

**Anything that is not explicitly provided for in the user guide is not allowed. The operator's proper operation can only be guaranteed if the instructions given herein are complied with. The Firm shall not be answerable for damage caused by failure to comply with the instructions featured herein.**

**While we will not alter the product's essential features, the Firm reserves the right, at any time, to make those changes deemed opportune to improve the product from a technical, design or commercial point of view, and will not be required to update this publication accordingly.**

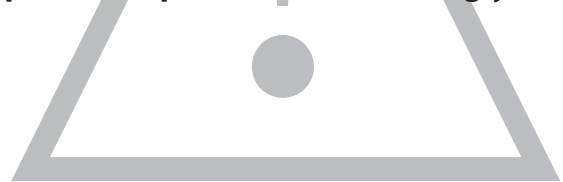

## INSTALLER WARNINGS

**WARNING! Important safety instructions. Carefully read and comply with all the warnings and instructions that come with the product as incorrect installation can cause injury to people and animals and damage to property. The warnings and instructions give important information regarding safety, installation, use and maintenance. Keep hold of instructions so that you can attach them to the technical file and keep them handy for future reference.**

### GENERAL SAFETY

This product has been designed and built solely for the purpose indicated herein. Uses other than those indicated herein might cause damage to the product and create a hazard.

- The units making up the machine and its installation must meet the requirements of the following European Directives, where applicable: 2014/30/EC, 2014/35/EC, 2006/42/EC, 2011/305/EC, 99/05/EC and later amendments. For all countries outside the EEC, it is advisable to comply with the standards mentioned, in addition to any national standards in force, to achieve a good level of safety.
- The Manufacturer of this product (hereinafter referred to as the "Firm") disclaims all responsibility resulting from improper use or any use other than that for which the product has been designed, as indicated herein, as well as for failure to apply Good Practice in the construction of entry systems (doors, gates, etc.) and for deformation that could occur during use.
- Installation must be carried out by qualified personnel (professional installer, according to EN 12635), in compliance with Good Practice and current code.
- Before installing the product, make all structural changes required to produce safety gaps and to provide protection from or isolate all crushing, shearing and dragging hazard areas and danger zones in general in accordance with the provisions of standards EN 12604 and 12453 or any local installation standards. Check that the existing structure meets the necessary strength and stability requirements.
- Before commencing installation, check the product for damage.
- The Firm is not responsible for failure to apply Good Practice in the construction and maintenance of the doors, gates, etc. to be motorized, or for deformation that might occur during use.
- Make sure the stated temperature range is compatible with the site in which the automated system is due to be installed.
- Do not install this product in an explosive atmosphere: the presence of flammable fumes or gas constitutes a serious safety hazard.
- Disconnect the electricity supply before performing any work on the system. Also disconnect buffer batteries, if any are connected.
- Before connecting the power supply, make sure the product's ratings match the mains ratings and that a suitable residual current circuit breaker and overcurrent protection device have been installed upline from the electrical system. Have the automated system's mains power supply fitted with a switch or omnipolar thermal-magnetic circuit breaker with a contact separation that provide full disconnection under overvoltage category III conditions.
- Make sure that upline from the mains power supply there is a residual current circuit breaker that trips at no more than 0.03A as well as any other equipment required by code.
- Make sure the earth system has been installed correctly: earth all the metal parts belonging to the entry system (doors, gates, etc.) and all parts of the system featuring an earth terminal.
- Installation must be carried out using safety devices and controls that meet standards EN 12978 and EN 12453.
- Impact forces can be reduced by using deformable edges.
- In the event impact forces exceed the values laid down by the relevant standards, apply electro-sensitive or pressure-sensitive devices.
- Apply all safety devices (photocells, safety edges, etc.) required to keep the area free of impact, crushing, dragging and shearing hazards. Bear in mind the standards and directives in force, Good Practice criteria, intended use, the installation environment, the operating logic of the system and forces generated by the automated system.
- Apply all signs required by current code to identify hazardous areas (residual risks). All installations must be visibly identified in compliance with the provisions of standard EN 13241-1.
- Once installation is complete, apply a nameplate featuring the door/gate's data.
- This product cannot be installed on leaves incorporating doors (unless the motor can be activated only when the door is closed).
- If the automated system is installed at a height of less than 2.5 m or is accessible, the electrical and mechanical parts must be suitably protected.
- For roller shutter automation only
  - 1) The motor's moving parts must be installed at a height greater than 2.5 m above the floor or other surface from which they may be reached.
  - 2) The gearmotor must be installed in a segregated and suitably protected space so that it cannot be reached without the aid of tools.
- Install any fixed controls in a position where they will not cause a hazard, away from moving parts. More specifically, hold-to-run controls must be positioned within direct sight of the part being controlled and, unless they are key operated, must be installed at a height of at least 1.5 m and in a place where they cannot be reached by the public.
- Apply at least one warning light (flashing light) in a visible position, and also attach a Warning sign to the structure.
- Attach a label near the operating device, in a permanent fashion, with information on how to operate the automated system's manual release.
- Make sure that, during operation, mechanical risks are avoided or relevant protective measures taken and, more specifically, that nothing can be banged, crushed, caught or cut between the part being operated and surrounding parts.
- Once installation is complete, make sure the motor automation settings are correct and that the safety and release systems are working properly.
- Only use original spare parts for any maintenance or repair work. The Firm disclaims all responsibility for the correct operation and safety of the automated system if parts from other manufacturers are used.
- Do not make any modifications to the automated system's components unless explicitly authorized by the Firm.
- Instruct the system's user on what residual risks may be encountered, on the control systems that have been applied and on how to open the system manually in an emergency. Give the user guide to the end user.

-Dispose of packaging materials (plastic, cardboard, polystyrene, etc.) in accordance with the provisions of the laws in force. Keep nylon bags and polystyrene out of reach of children.

### WIRING

**WARNING!** For connection to the mains power supply, use a multicore cable with a cross-sectional area of at least 5x1.5mm<sup>2</sup> or 4x1.5mm<sup>2</sup> when dealing with three-phase power supplies or 3x1.5mm<sup>2</sup> for single-phase supplies (by way of example, type H05RN-F cable can be used with a cross-sectional area of 4x1.5mm<sup>2</sup>). To connect auxiliary equipment, use wires with a cross-sectional area of at least 0.5 mm<sup>2</sup>.

- Only use pushbuttons with a capacity of 10A-250V or more.
- Wires must be secured with additional fastening near the terminals (for example, using cable clamps) in order to keep live parts well separated from safety extra low voltage parts.
- During installation, the power cable must be stripped to allow the earth wire to be connected to the relevant terminal, while leaving the live wires as short as possible. The earth wire must be the last to be pulled taut in the event the cable's fastening device comes loose.

**WARNING!** safety extra low voltage wires must be kept physically separate from low voltage wires.

Only qualified personnel (professional installer) should be allowed to access live parts.

### CHECKING THE AUTOMATED SYSTEM AND MAINTENANCE

Before the automated system is finally put into operation, and during maintenance work, perform the following checks meticulously:

- Make sure all components are fastened securely.
- Check starting and stopping operations in the case of manual control.
- Check the logic for normal or personalized operation.
- For sliding gates only: check that the rack and pinion mesh correctly with 2 mm of play along the full length of the rack; keep the track the gate slides on clean and free of debris at all times.
- For sliding gates and doors only: make sure the gate's running track is straight and horizontal and that the wheels are strong enough to take the weight of the gate.
- For cantilever sliding gates only: make sure there is no dipping or swinging during operation.
- For swing gates only: make sure the leaves' axis of rotation is perfectly vertical.
- For barriers only: before opening the door, the spring must be decompressed (vertical boom).
- Check that all safety devices (photocells, safety edges, etc.) are working properly and that the anti-crush safety device is set correctly, making sure that the force of impact measured at the points provided for by standard EN 12445 is lower than the value laid down by standard EN 12453.
- Impact forces can be reduced by using deformable edges.
- Make sure that the emergency operation works, where this feature is provided.
- Check opening and closing operations with the control devices applied.
- Check that electrical connections and cabling are intact, making extra sure that insulating sheaths and cable glands are undamaged.
- While performing maintenance, clean the photocells' optics.
- When the automated system is out of service for any length of time, activate the emergency release (see "EMERGENCY OPERATION" section) so that the operated part is made idle, thus allowing the gate to be opened and closed manually.
- If the power cord is damaged, it must be replaced by the manufacturer or their technical assistance department or other such qualified person to avoid any risk.
- If "D" type devices are installed (as defined by EN12453), connect in unverified mode, foresee mandatory maintenance at least every six months
- The maintenance described above must be repeated at least once yearly or at shorter intervals where site or installation conditions make this necessary.

### WARNING!

Remember that the drive is designed to make the gate/door easier to use and will not solve problems as a result of defective or poorly performed installation or lack of maintenance



### SCRAPPING

Materials must be disposed of in accordance with the regulations in force. Do not throw away your discarded equipment or used batteries with household waste. You are responsible for taking all your waste electrical and electronic equipment to a suitable recycling centre.

### DISMANTLING

If the automated system is being dismantled in order to be reassembled at another site, you are required to:

- Cut off the power and disconnect the whole electrical system.
- Remove the actuator from the base it is mounted on.
- Remove all the installation's components.
- See to the replacement of any components that cannot be removed or happen to be damaged.

**DECLARATIONS OF CONFORMITY CAN BE FOUND AT <http://www.bft-automation.com/CE>  
INSTRUCTIONS FOR USE AND ASSEMBLY CAN BE FOUND IN THE DOWN-LOAD SECTION.**

**Anything that is not explicitly provided for in the installation manual is not allowed. The operator's proper operation can only be guaranteed if the information given is complied with. The Firm shall not be answerable for damage caused by failure to comply with the instructions featured herein.**

**While we will not alter the product's essential features, the Firm reserves the right, at any time, to make those changes deemed opportune to improve the product from a technical, design or commercial point of view, and will not be required to update this publication accordingly.**

# INSTALLAZIONE VELOCE-QUICK INSTALLATION-INSTALLATION RAPIDE SCHNELLINSTALLATION-INSTALACIÓN RÁPIDA - SNELLE INSTALLATIE

D812865 00100\_04

## PREDISPOSIZIONE TUBI, TUBE ARRANGEMENT, PRÉDISPOSITION DES TUYAUX, VORBEREITUNG DER LEITUNGEN, DISPOSICIÓN DE TUBOS, VOORBEREIDING LEIDINGEN.

**A**

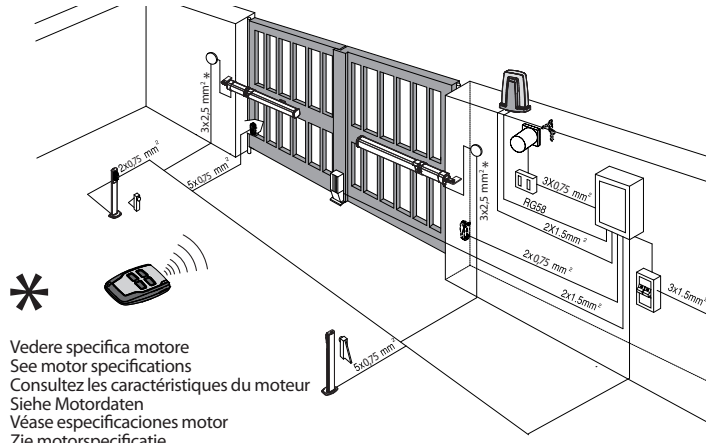

## Collegamento Elettroserratura EBP 230V. Configurazione AUX= Lampeggiante EBP solenoid lock connection 230V. AUX configuration = Flashing Connexion serrure électrique EBP 230V. Configuration AUX= Clignotant Anschluss Elektroschloss EBP 230V. Konfiguration AUX= Blinkleuchte Conexión Cerradura eléctrica EBP 230V. Configuración AUX= Parpadeante Verbinding Elektrisch slot EBP 230V. Configuratie AUX= Knipperend

**B**

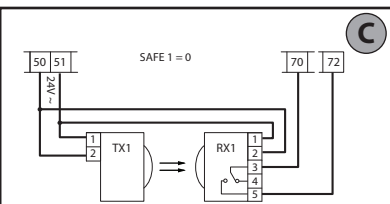
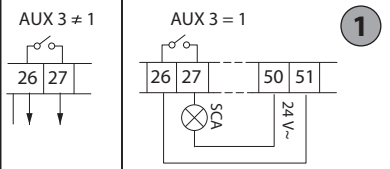
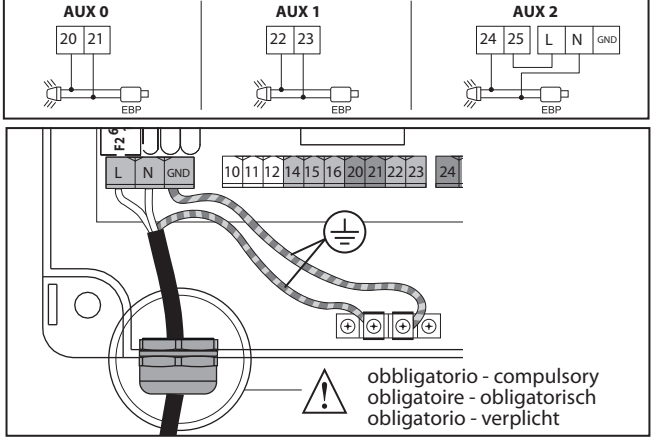

Collegamento di 1 coppia di fotocellule non verificate, per fotocellule verificate vedere pagine seguenti.  
Connection of 1 couple of untested photocells, for tested photocells see the following pages.  
Connexion d'une paire de photocellules non vérifiées, pour les photocellules vérifiées consultez les pages suivantes.  
Anschluss von einem Paar nicht überprüfter Fotozellen, für überprüfte Fotozelle siehe die folgenden Seiten.  
Conexión de 1 par de fotocélulas no comprobadas, para fotocélulas comprobadas véanse las siguientes páginas.  
Aansluiting van 1 paar niet-geverifieerde fotocellen. Raadpleeg de volgende pagina's voor geverifieerde fotocellen.

\* Altre tensioni disponibili a richiesta  
Other voltages available on request  
Autres tensions disponibles sur demande  
Weitere Spannungen auf Anfrage erhältlich  
Otras tensiones disponibles a petición  
Andere spanningen op aanvraag beschikbaar

\*\* Non in dotazione  
Not supplied  
Ne sont pas fournis  
Nicht im lieferum  
No asignadas en el equipamiento base  
Niet meegeleverd

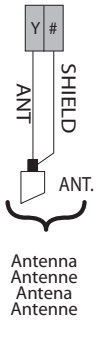
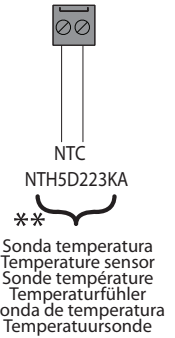
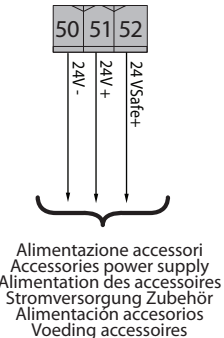
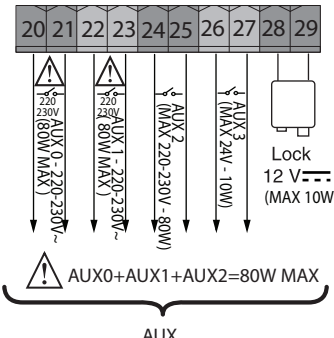
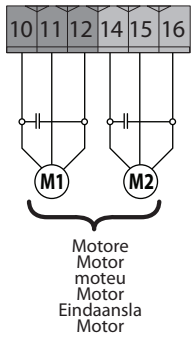
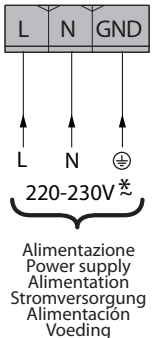
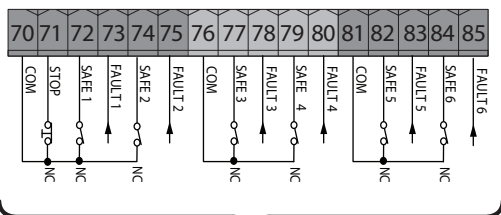
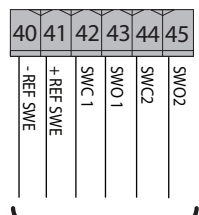
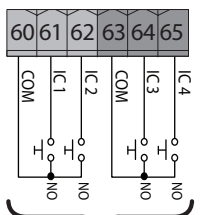
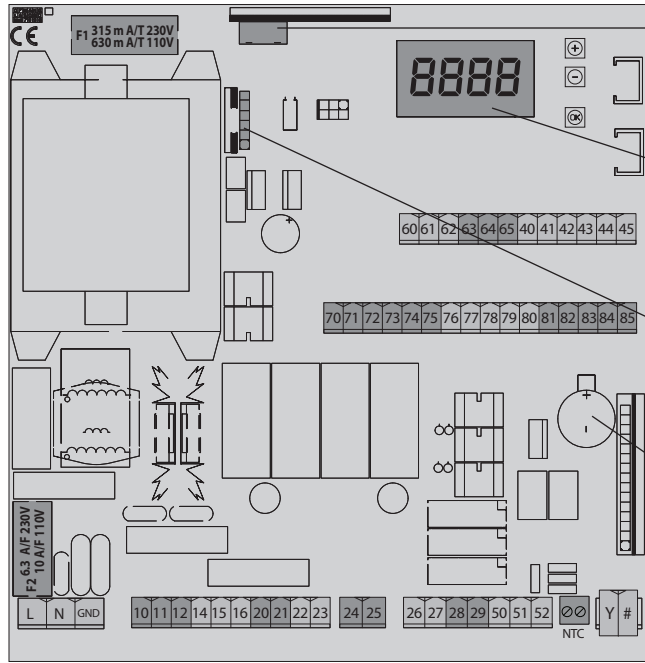

## MENU SEMPLIFICATO

\*\*\* Inserimento password.

Richiesta con logica Livello Protezione impostata a 1, 2, 3, 4

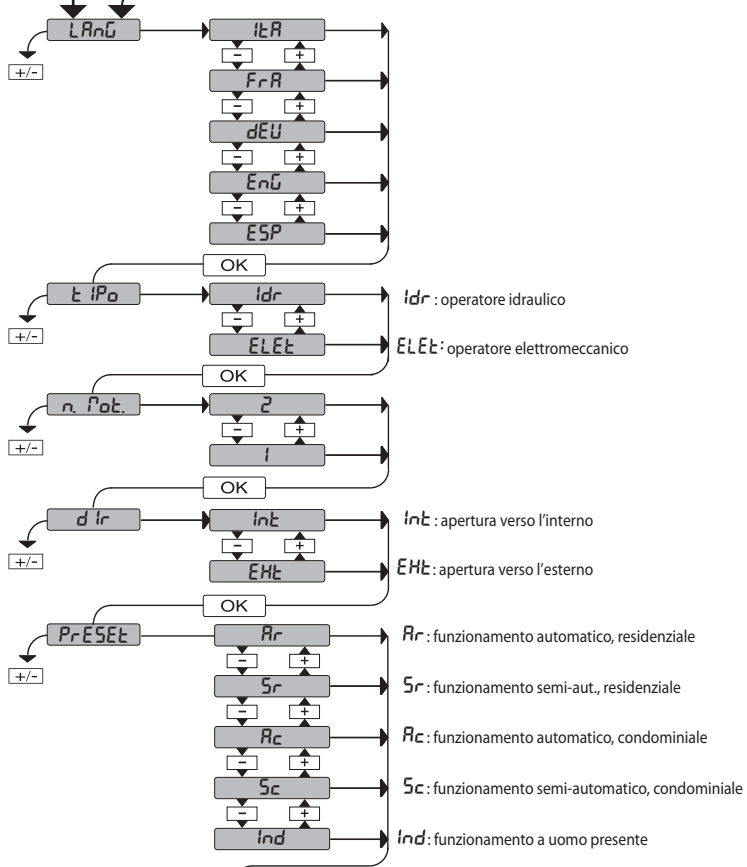
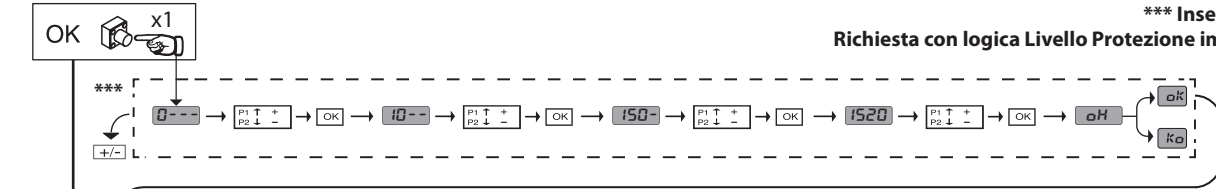

**LEGENDA**

+ ↑ Scorri su

- ↓ Scorri giù

OK ↵ Conferma/ Accensione display

+ ✎ Uscita menu

- ✎ Uscita menu

PRESET		DEFAULT	Rr	Sr	Rc	Sc	Ind
<b>PARAMETRI</b>							
Tempo di lavoro Motore 1		60.0	20.0	20.0	20.0	20.0	20.0
Tempo di lavoro Motore 2		60.0	20.0	20.0	20.0	20.0	20.0
Tempo sfasamento apertura		3	2	2	2	2	2
Tempo sfasamento chiusura		3	2	2	2	2	2
Tempo di rallentamento motore 1	idraulico	0	0	0	0	0	0
	elettromeccanico		3	3	3	3	3
Tempo di rallentamento motore 2	idraulico	0	0	0	0	0	0
	elettromeccanico		3	3	3	3	3
TCA		40	20	40	30	40	40
Forza apertura	idraulico	50	99	99	99	99	99
	elettromeccanico		50	50	50	50	50
Forza chiusura	idraulico	50	99	99	99	99	99
	elettromeccanico		50	50	50	50	50
Forza rallentamento	idraulico	50	99	99	99	99	99
	elettromeccanico		50	50	50	50	50
<b>LOGICHE</b>							
TCA		0	1	0	1	0	0
Movimento passo passo		0	1	0	1	0	0
Preallarme		0	0	0	1	1	0
Uomo presente		0	0	0	0	0	1
Blocca impulsi in apertura		0	0	0	1	1	0
Manutenimento blocco	idraulico	0	1	1	1	1	1
	elettromeccanico		0	0	0	0	0
SAFE1		0	4	4	4	4	0
Livello Protezione		0	0	0	0	0	2

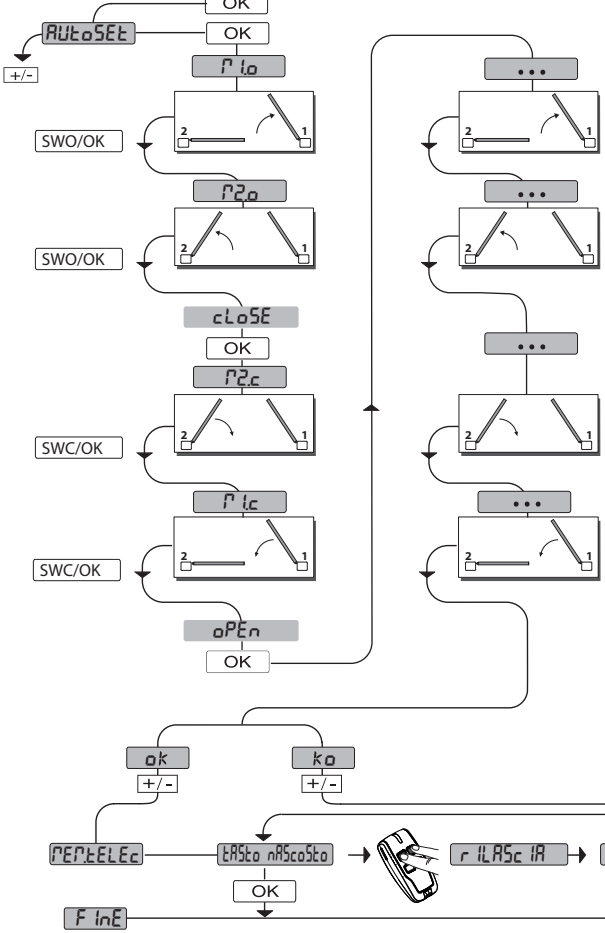

# SIMPLIFIED MENU

\*\*\* Password entry.

Request with Protection Level logic set to 1, 2, 3, 4

D812865 00100\_04

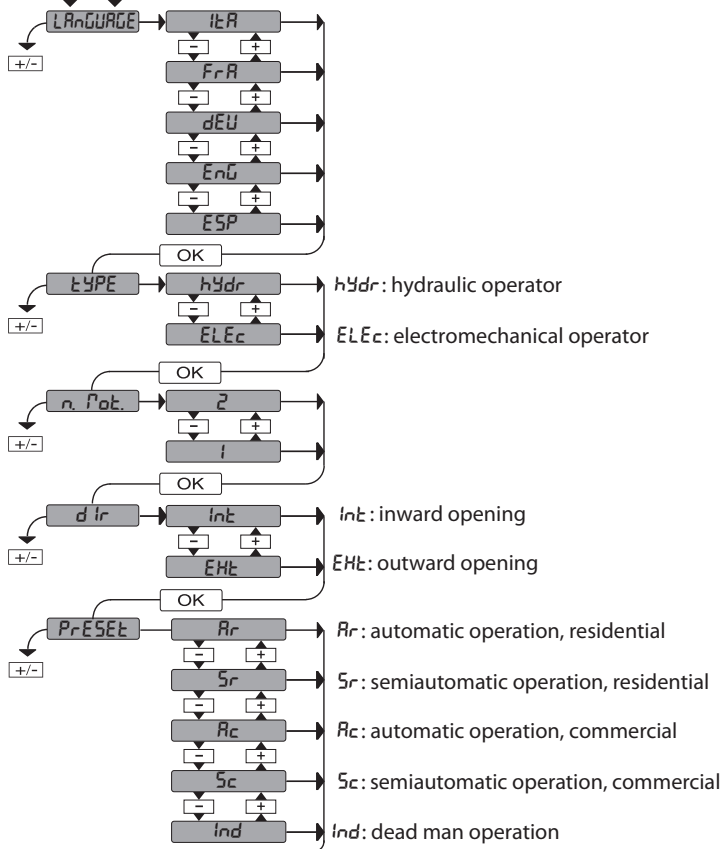
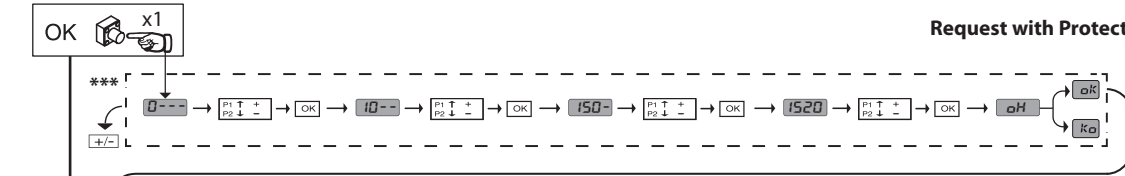

### LEGENDA

- + ↑ Scroll up
- ↓ Scroll down
- OK Confirm/Switch on display
- +/- Exit Menü

PRESET	DEFAULT	Rr	Sr	Rc	Sc	ind
<b>PARAMETER</b>						
Operation time motor 1	60.0	20.0	20.0	20.0	20.0	20.0
Operation time motor 2	60.0	20.0	20.0	20.0	20.0	20.0
Time lag opening	3	2	2	2	2	2
Time lag closing	3	2	2	2	2	2
Motor 1 slow-down time	hydraulic	0	0	0	0	0
	electromechanical	3	3	3	3	3
Motor 2 slow-down time	hydraulic	0	0	0	0	0
	electromechanical	3	3	3	3	3
TCA	40	20	40	30	40	40
Opening force	hydraulic	50	99	99	99	99
	electromechanical	50	50	50	50	50
Closing force	hydraulic	50	99	99	99	99
	electromechanical	50	50	50	50	50
Slow-down force	hydraulic	50	99	99	99	99
	electromechanical	50	50	50	50	50
<b>LOGIC</b>						
TCA	0	1	0	1	0	0
Step-by-step movement	0	1	0	1	0	0
Pre alarm	0	0	0	1	1	0
Hold-to-run	0	0	0	0	0	1
Impulse lock on opening	0	0	0	1	1	0
Lock hold	hydraulic	0	1	1	1	1
	electromechanical	0	0	0	0	0
SAFE 1	0	4	4	4	4	0
Protection level	0	0	0	0	0	2

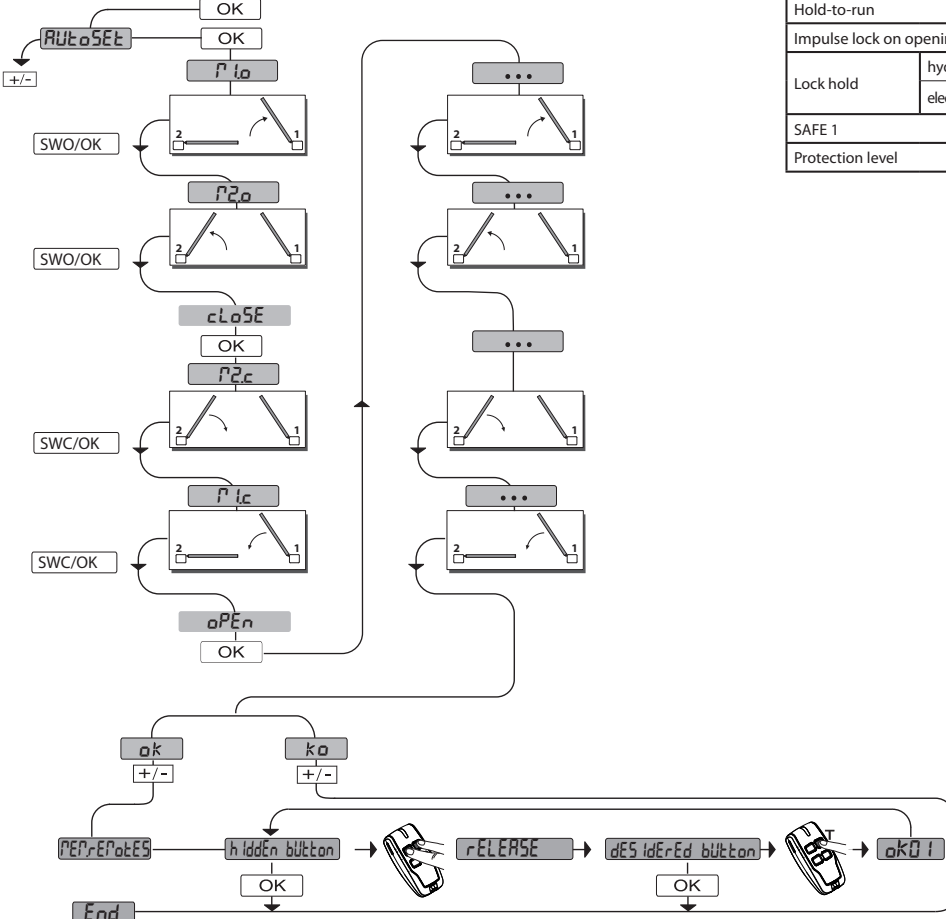

# MENU SIMPLIFIÉ

\*\*\* Saisie du mot de passe.  
Demande avec logique Niveau Protection configurée sur  
1, 2, 3, 4

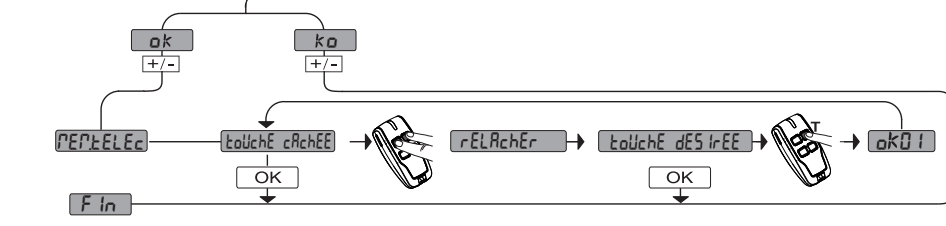
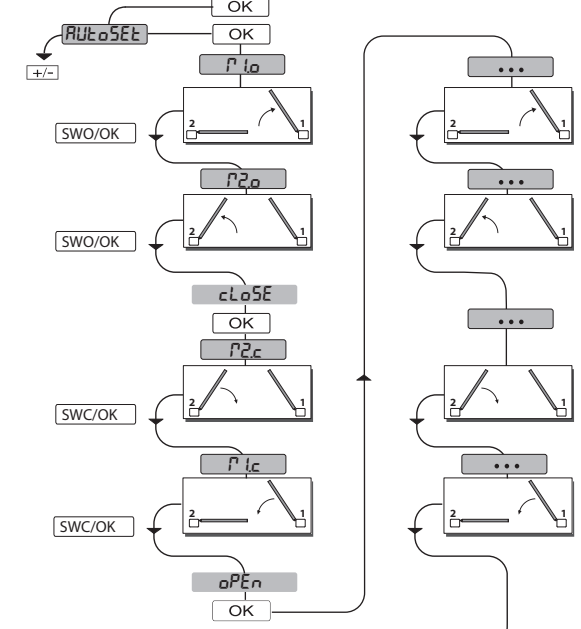
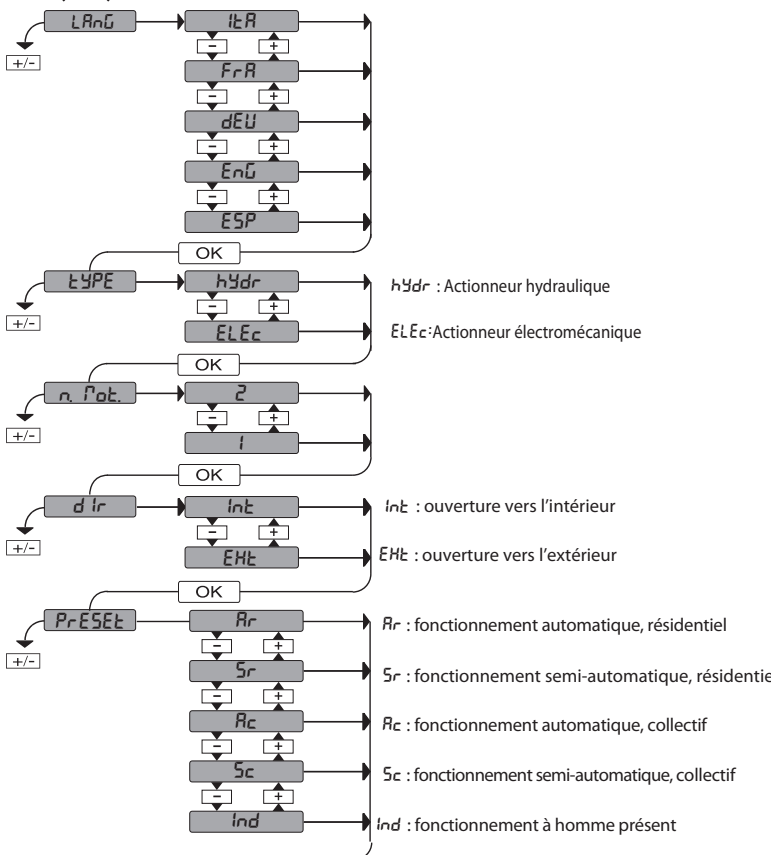
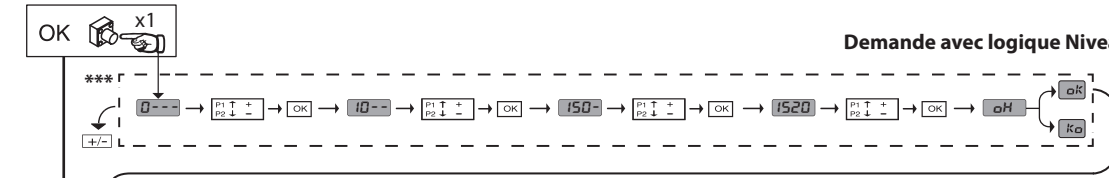

**LEGENDA**

8888

+ ↑ Monter

- ↓ Descendre

OK ← Confirmation / allumage afficheur

+ OK

- OK

→

Sortir du menu

PRESET		DEFAULT	Rr	Sr	Rc	Sc	ind
<b>PARAMÈTRES</b>							
Temps de travail moteur 1		60.0	20.0	20.0	20.0	20.0	20.0
Temps de travail moteur 2		60.0	20.0	20.0	20.0	20.0	20.0
Temps déphasage ouverture		3	2	2	2	2	2
Temps déphasage fermeture		3	2	2	2	2	2
Temps ralentissement moteur 1	hydraulique	0	0	0	0	0	0
	electromecanique		3	3	3	3	3
Temps ralentissement moteur 2	hydraulique	0	0	0	0	0	0
	electromecanique		3	3	3	3	3
TCA		40	20	40	30	40	40
Force ouverture	hydraulique	50	99	99	99	99	99
	electromecanique		50	50	50	50	50
Force fermeture	hydraulique	50	99	99	99	99	99
	electromecanique		50	50	50	50	50
Force ralentissement	hydraulique	50	99	99	99	99	99
	electromecanique		50	50	50	50	50
<b>LOGIQUES</b>							
TCA		0	1	0	1	0	0
Force ralentissement		0	1	0	1	0	0
Préalarme		0	0	0	1	1	0
Homme présent		0	0	0	0	0	1
Blocage des Impulsions d'ouverture		0	0	0	1	1	0
Maintien du blocage	hydraulique	0	1	1	1	1	1
	electromecanique		0	0	0	0	0
SAFE 1		0	4	4	4	4	0
Niveau de protection		0	0	0	0	0	2



# VEREINFACHTES MENÜ

\*\*\* Passwordeingabe

Anforderung mit Schutzniveaulogik eingestellt auf 1, 2, 3 oder 4

D812865 00100\_04

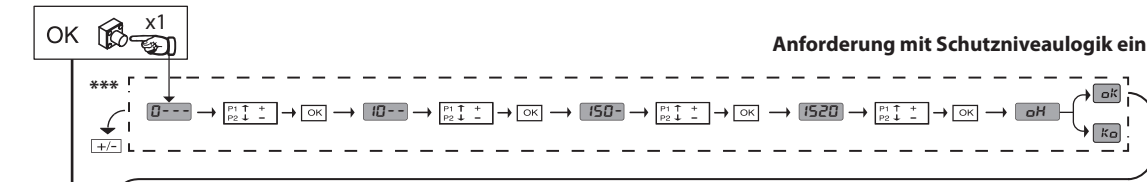

**LEGENDE**

+ ↑ Aufwärts  
 - ↓ Abwärts  
 OK ← Bestätigung/  
 Aufleuchten Display  
 +/- Zurück zum  
 Hauptmenü

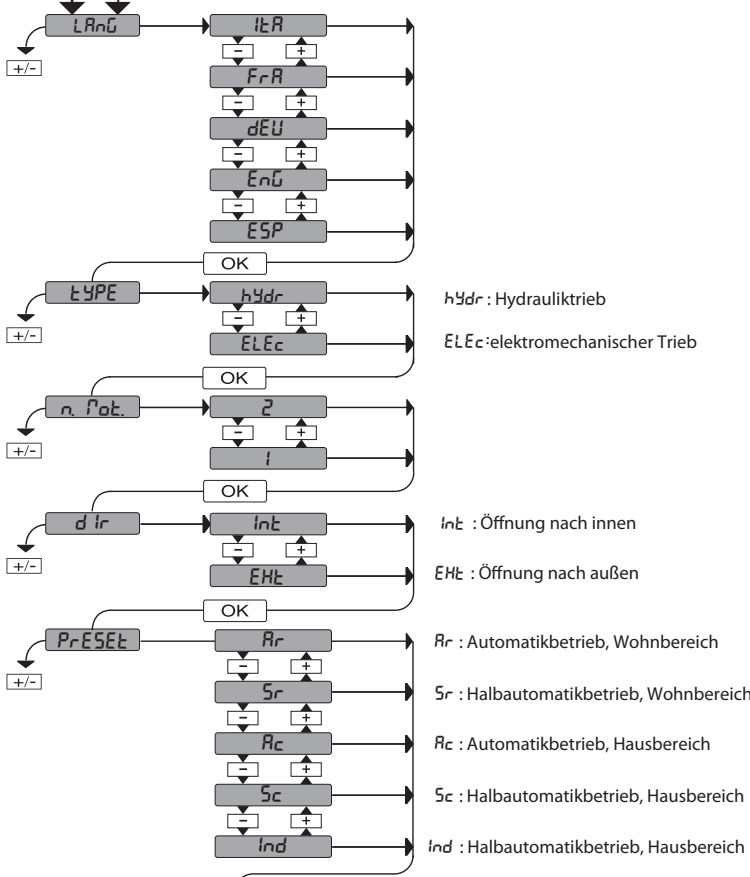

PRESET	DEFAULT	Rr	Sr	Rc	Sc	ind
<b>PARAMETER</b>						
Arbeitszeit für motor 1	60.0	20.0	20.0	20.0	20.0	20.0
Arbeitszeit für motor 2	60.0	20.0	20.0	20.0	20.0	20.0
Verschiebungszeit Öffnung	3	2	2	2	2	2
Verschiebungszeit Schließung	3	2	2	2	2	2
Verlangsamungszeit Motor 1	hydraulischer	0	0	0	0	0
	elektromechanischer	3	3	3	3	3
Verlangsamungszeit Motor 2	hydraulischer	0	0	0	0	0
	elektromechanischer	3	3	3	3	3
TCA	40	20	40	30	40	40
Kraft Öffnung	hydraulischer	99	99	99	99	99
	elektromechanischer	50	50	50	50	50
Kraft Schließung	hydraulischer	99	99	99	99	99
	elektromechanischer	50	50	50	50	50
Verlangsamungskraft	hydraulischer	99	99	99	99	99
	elektromechanischer	50	50	50	50	50
<b>LOGIC</b>						
TCA	0	1	0	1	0	0
Einzelschrittbewegung	0	1	0	1	0	0
Voralarm	0	0	0	1	1	0
Totmann-Funktion	0	0	0	0	0	1
Impulssperre bei der Öffnung	0	0	0	1	1	0
Aufrechterhalten der Sperre	hydraulischer	1	1	1	1	1
	elektromechanischer	0	0	0	0	0
SAFE1	0	4	4	4	4	0
Schutzniveau	0	0	0	0	0	2

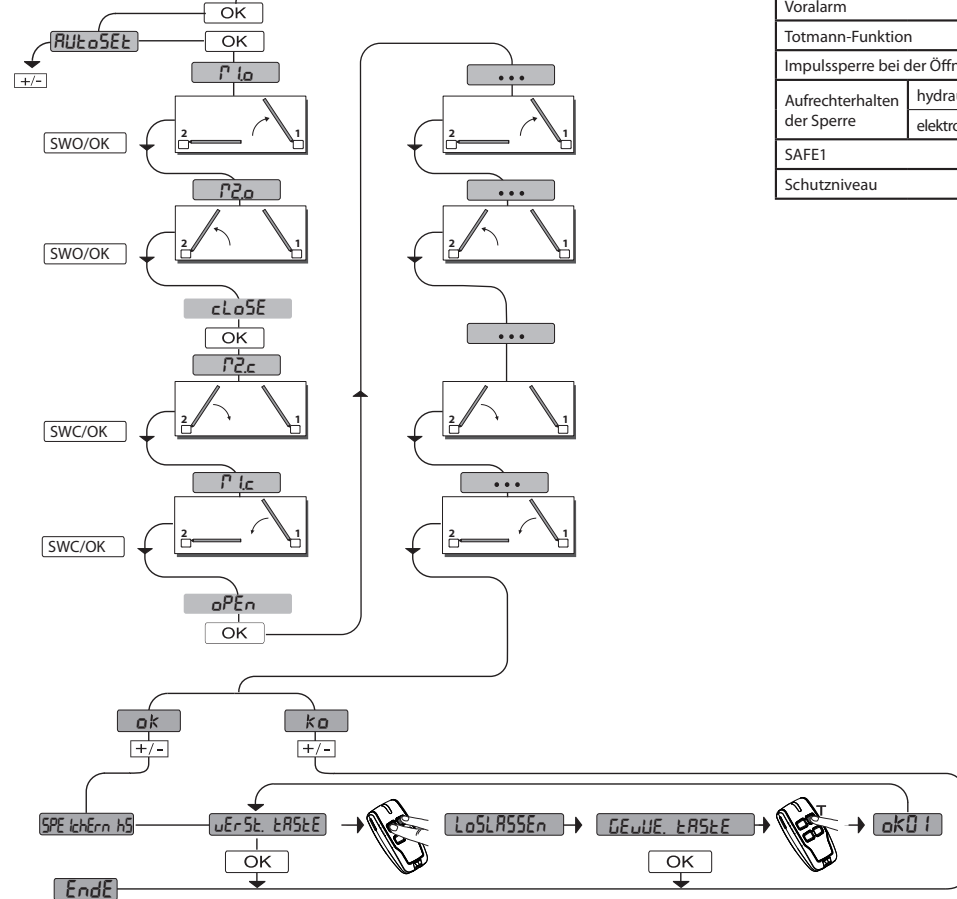

# MENÚ SIMPLIFICADO

\*\*\* Introducción contraseña.

Solicitud con lógica Nivel Protección configurada a 1, 2, 3, 4

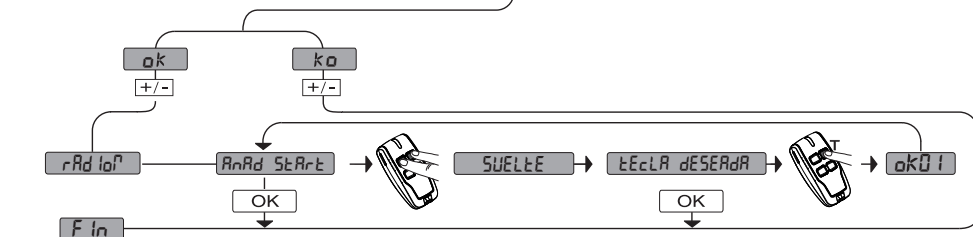
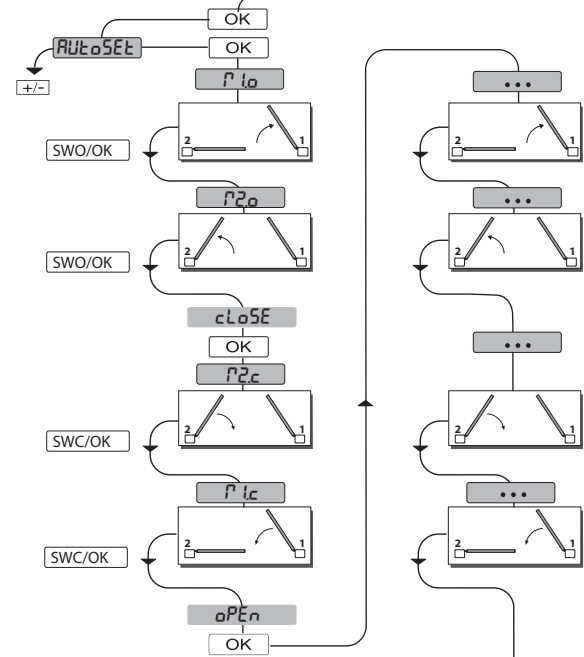
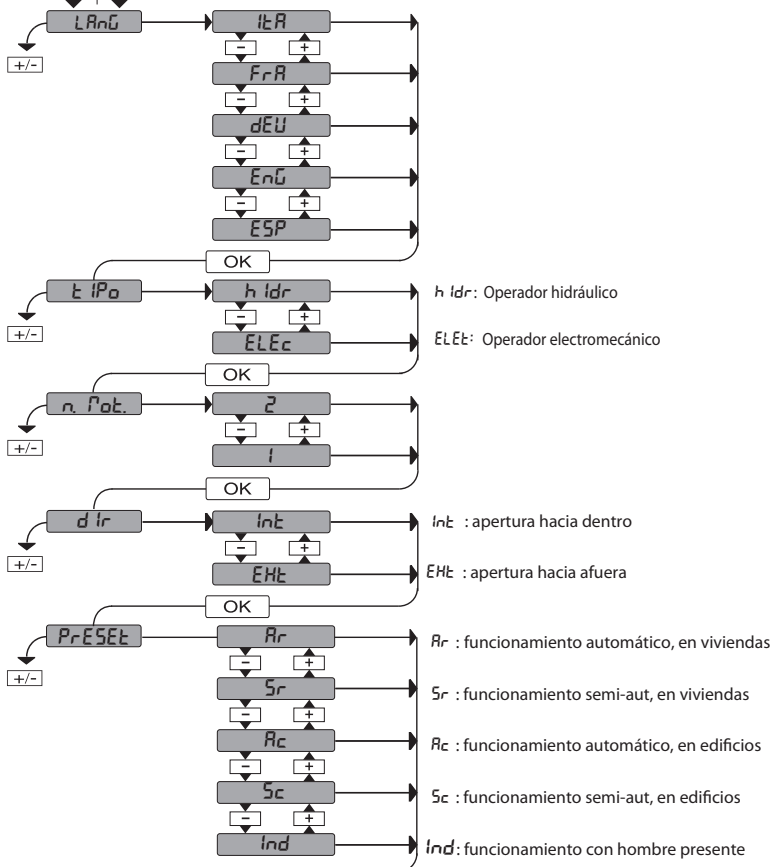
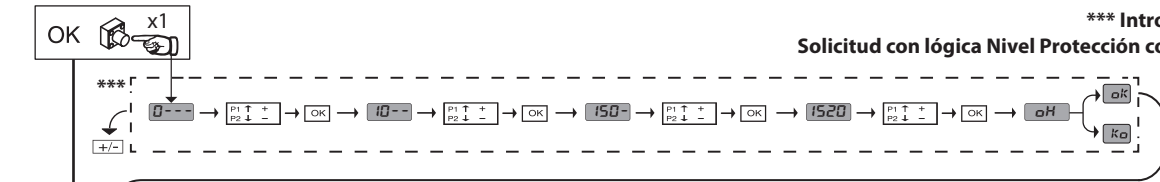

**LEYENDA**

8888

+

↑

Desplazar hacia arriba

8888

-

↓

Desplazar hacia abajo

8888

OK

←

Confirmación/  
Encendido pantalla

+

-

←

Retorno al menú  
principal

PRESET	DEFAULT	Rr	Sr	Rc	Sc	Ind
<b>PARAMETROS</b>						
Tiempo de trabajo motor 1	60.0	20.0	20.0	20.0	20.0	20.0
Tiempo de trabajo motor 2	60.0	20.0	20.0	20.0	20.0	20.0
Tiempo desfase apertura	3	2	2	2	2	2
Tiempo desfase cierre	3	2	2	2	2	2
Tiempo de deceleración motor 1	hidráulico	0	0	0	0	0
	electromecánico	0	3	3	3	3
Tiempo de deceleración motor 2	hidráulico	0	0	0	0	0
	electromecánico	0	3	3	3	3
TCA	40	20	40	30	40	40
Fuerza de apertura	hidráulico	99	99	99	99	99
	electromecánico	50	50	50	50	50
Fuerza de cierre	hidráulico	99	99	99	99	99
	electromecánico	50	50	50	50	50
Fuerza deceleración	hidráulico	99	99	99	99	99
	electromecánico	50	50	50	50	50
<b>LOGICA</b>						
TCA	0	1	0	1	0	0
Movimiento paso a paso	0	1	0	1	0	0
Pre alarma	0	0	0	1	1	0
Hombre Presente	0	0	0	0	0	1
Bloquea impulsos en fase de apertura	0	0	0	1	1	0
Mantenimiento del bloqueo	hidráulico	0	1	1	1	1
	electromecánico	0	0	0	0	0
SAFE1	0	4	4	4	4	0
Nivel Protección	0	0	0	0	0	2

# VEREENVOUDIGD MENU

\*\*\* Password invoeren.

Aanvraag met logica Beschermingsniveau ingesteld op 1, 2, 3, 4

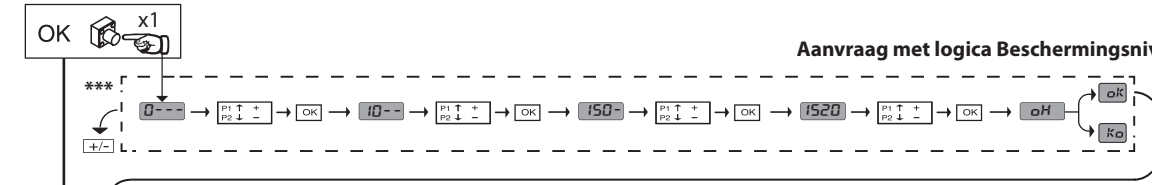

### LEGENDE

- + ↑ Doorloop op
- ↓ Doorloop naar
- OK ↵ Bevestig / Aanschakeling display
- +/- Terugkeer naar het hoofdmenu

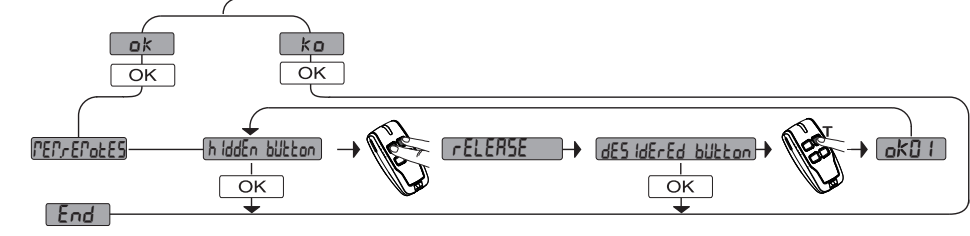
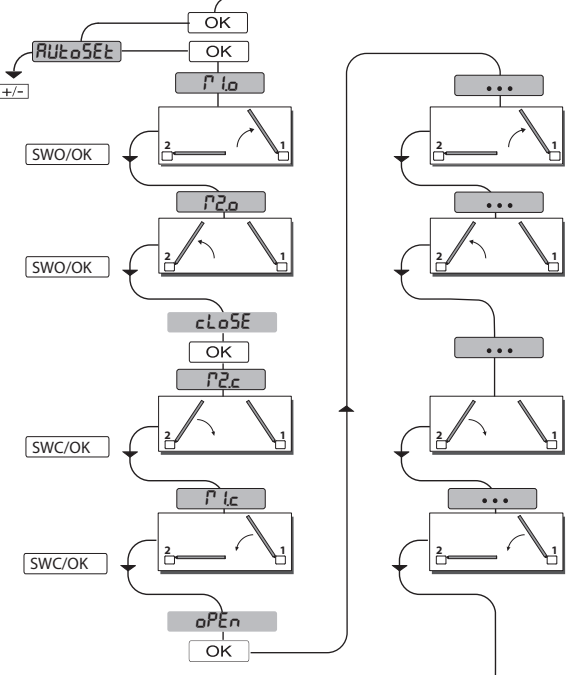
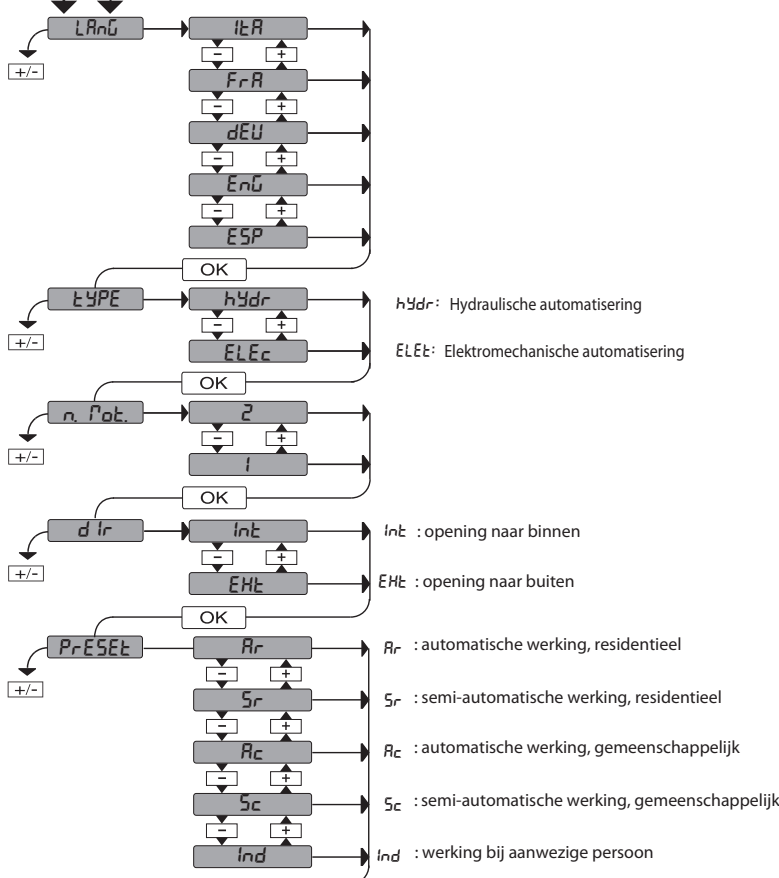

PRESET	DEFAULT	Rr	Sr	Rc	Sc	Ind
<b>PARAMETERS</b>						
Werktijd motor 1	60.0	20.0	20.0	20.0	20.0	20.0
Werktijd motor 2	60.0	20.0	20.0	20.0	20.0	20.0
Tijd van faseverschil opening	3	2	2	2	2	2
Tijd van faseverschil sluiting	3	2	2	2	2	2
Tijd van afremming motor 1	hydraulische	0	0	0	0	0
	elektromechanische	3	3	3	3	3
Tijd van afremming motor 2	hydraulische	0	0	0	0	0
	elektromechanische	3	3	3	3	3
TCA	40	20	40	30	40	40
Openingskracht	hydraulische	50	99	99	99	99
	elektromechanische	50	50	50	50	50
Sluitkracht	hydraulische	50	99	99	99	99
	elektromechanische	50	50	50	50	50
Afremmingskracht	hydraulische	50	99	99	99	99
	elektromechanische	50	50	50	50	50
<b>LOGICA</b>						
TCA	0	1	0	1	0	0
Stap-voor-stap beweging	0	1	0	1	0	0
Pre-alarm	0	0	0	1	1	0
Persoon Aanwezig	0	0	0	0	0	1
Blokkeert impulsen bij opening	0	0	0	1	1	0
Handhaving blokkering	hydraulische	0	1	1	1	1
	elektromechanische	0	0	0	0	0
SAFE1	0	4	4	4	4	0
Beschermingsniveau	0	0	0	0	0	2

**AUTOSET PER MOTORI CON FINECORSA / AUTOSET FOR MOTORS WITH LIMIT SWITCHES**  
**AUTOCONFIGURATION POUR MOTEURS AVEC FIN DE COURSE / AUTOSET FÜR MOTOREN MIT ENDSCHALTER**  
**AUTOSET PARA MOTORES CON FINAL DE CARRERA / AUTOSET VOOR MOTOREN MET EINDAANSLAGEN**

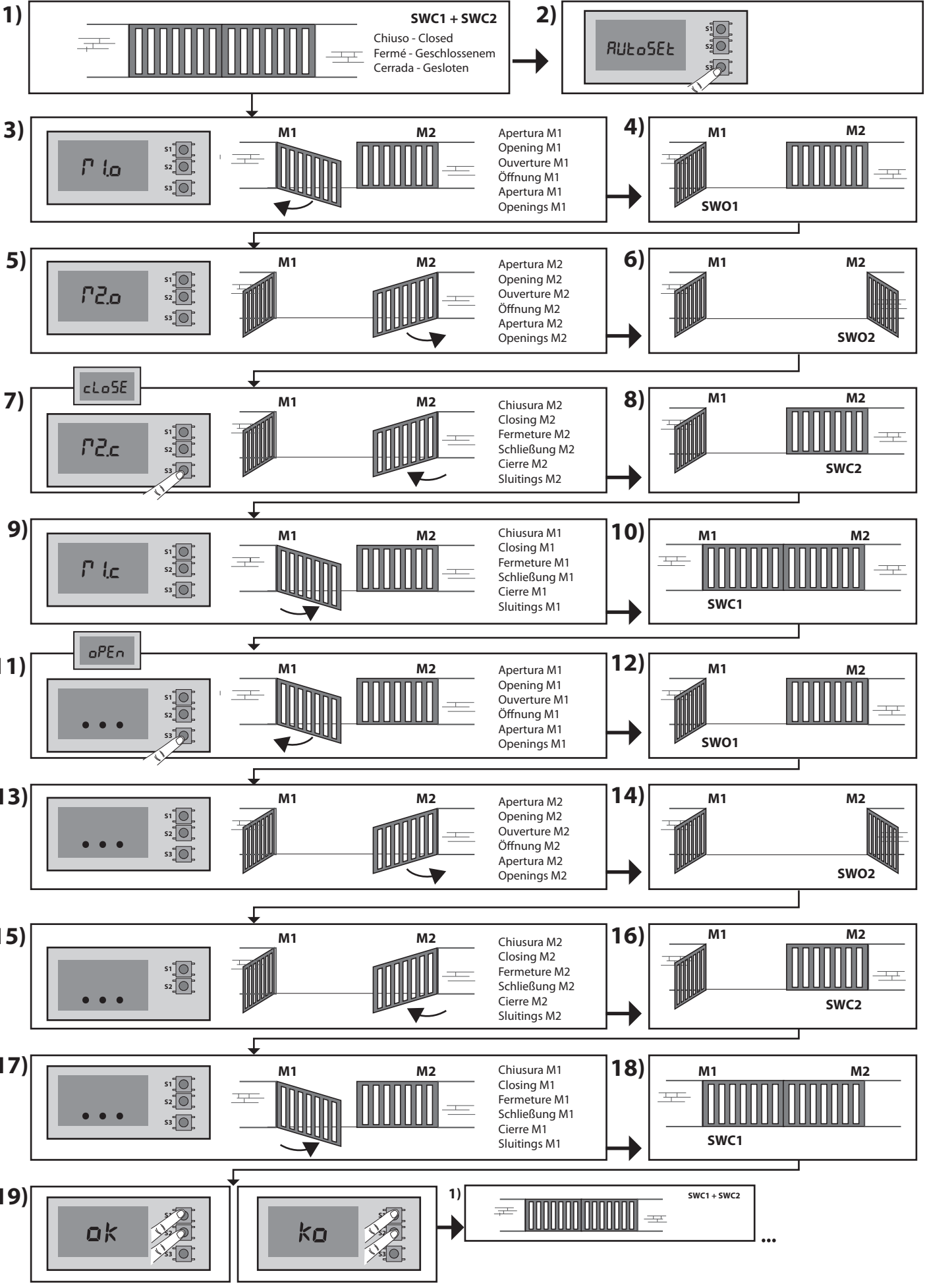

ITALIANO

ENGLISH

FRANÇAIS

DEUTSCH

ESPAÑOL

NEDERLANDS

**AUTOSET PER MOTORI SPROVVISTI DI FINECORSA / AUTOSET FOR MOTORS WITH NO LIMIT SWITCHES**  
**AUTOCONFIGURATION POUR MOTEURS SANS FIN DE COURSE / AUTOSET FÜR MOTOREN OHNE ENDSCHALTER**  
**AUTOSET PARA MOTORES SIN FINAL DE CARRERA / AUTOSET VOOR MOTOREN ZONDER EINDAANSLAGEN**

**D2**

D812865 00100\_04

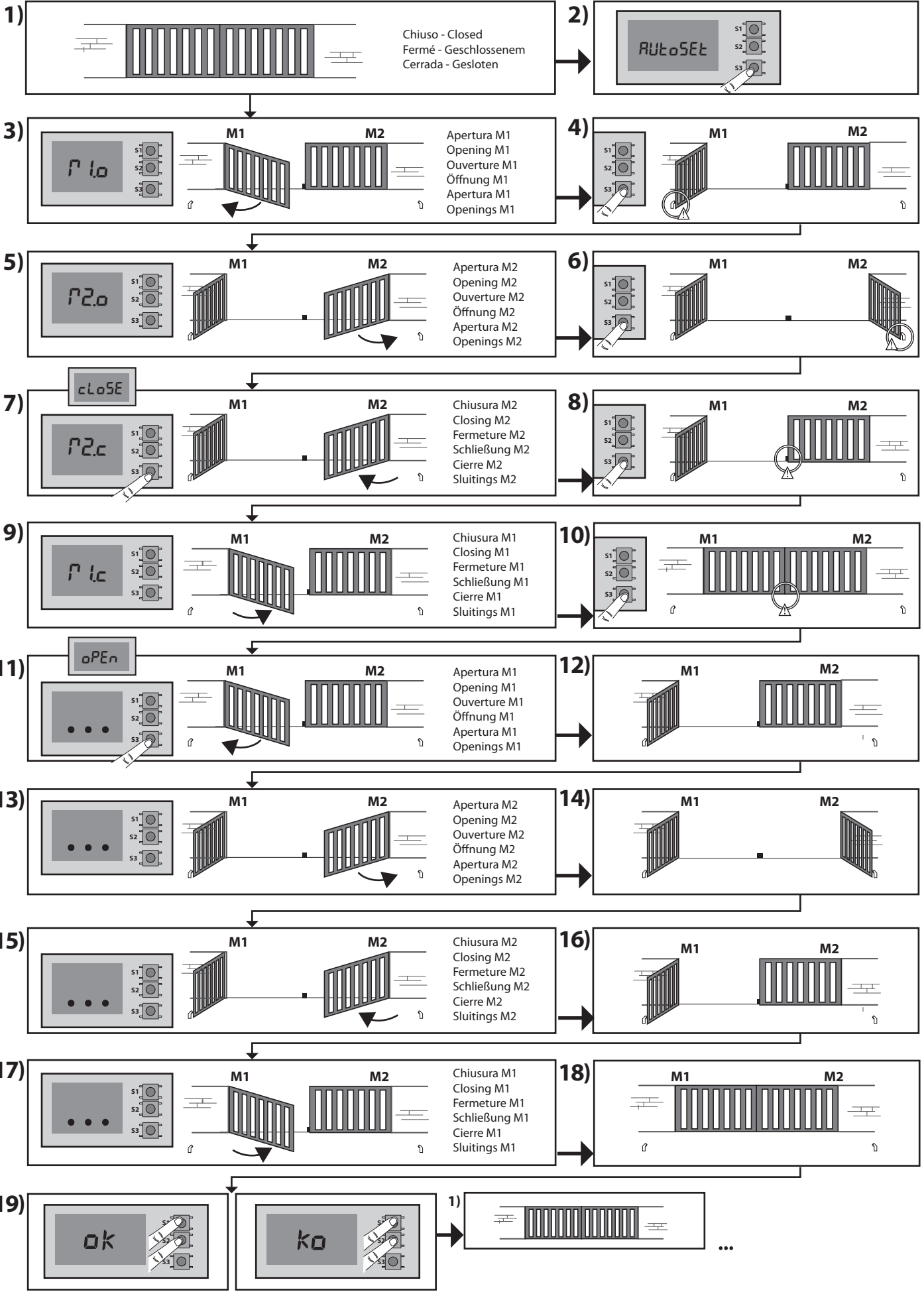

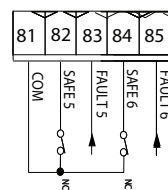
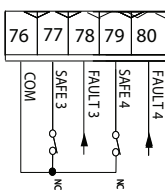
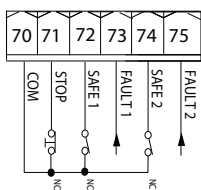
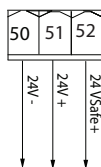

E

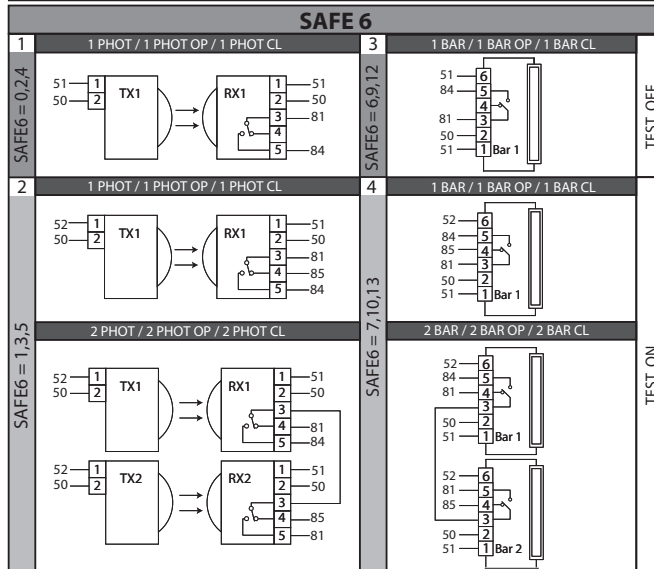
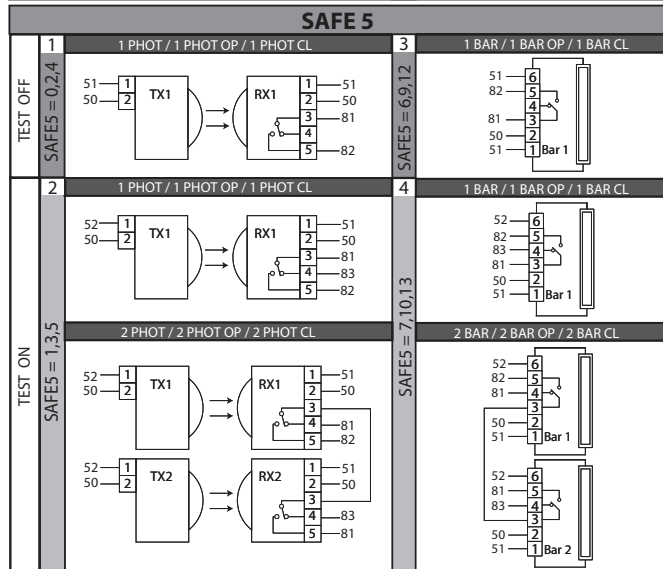
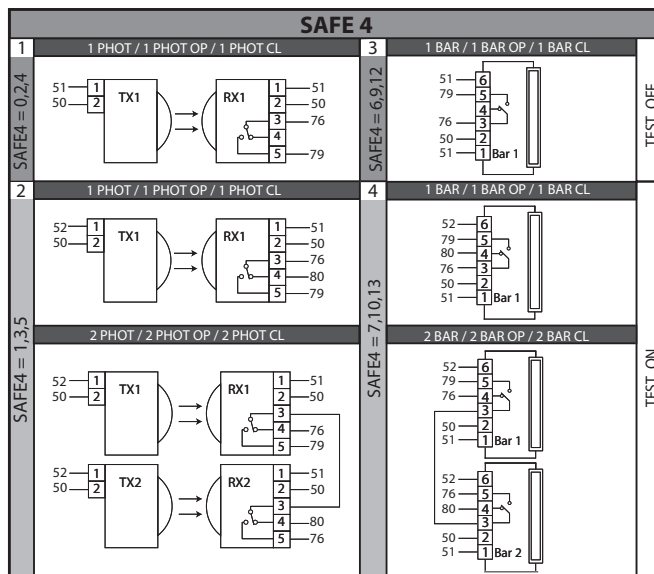
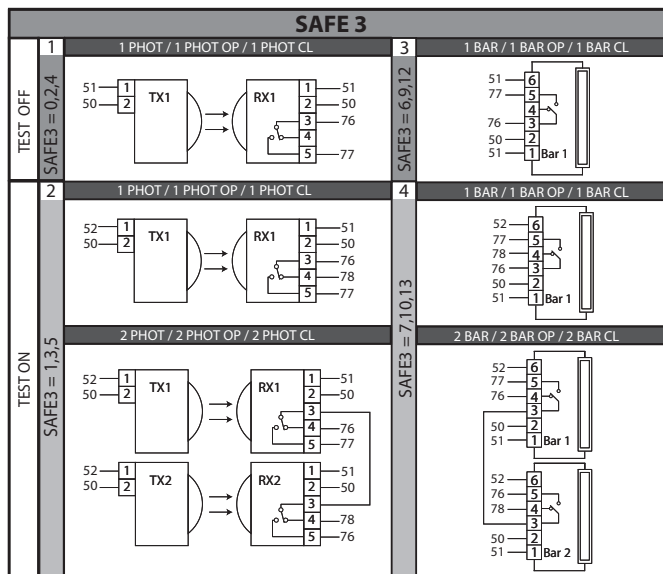
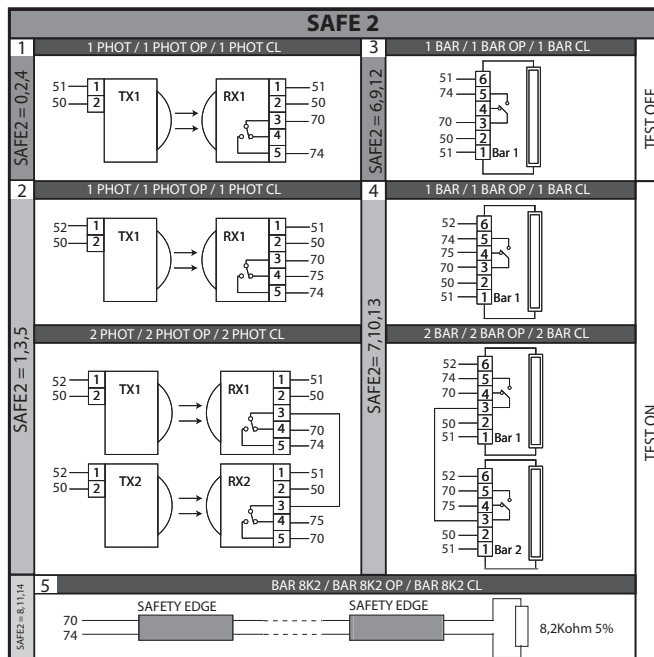
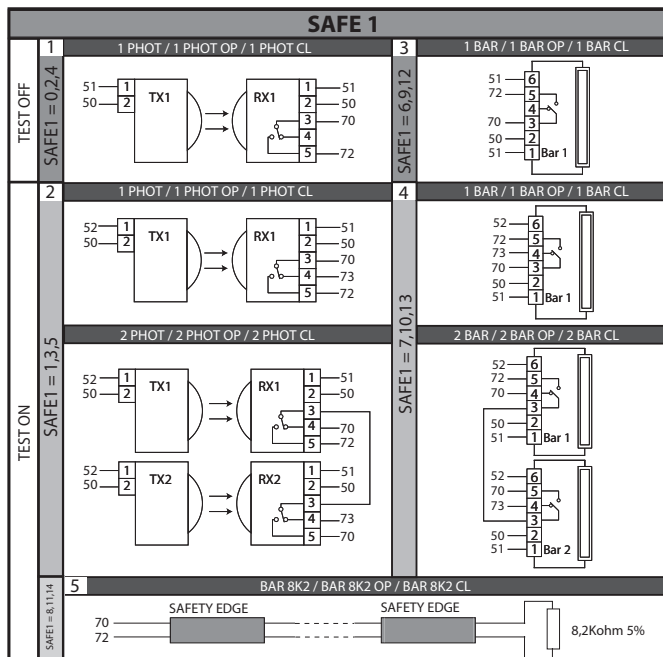

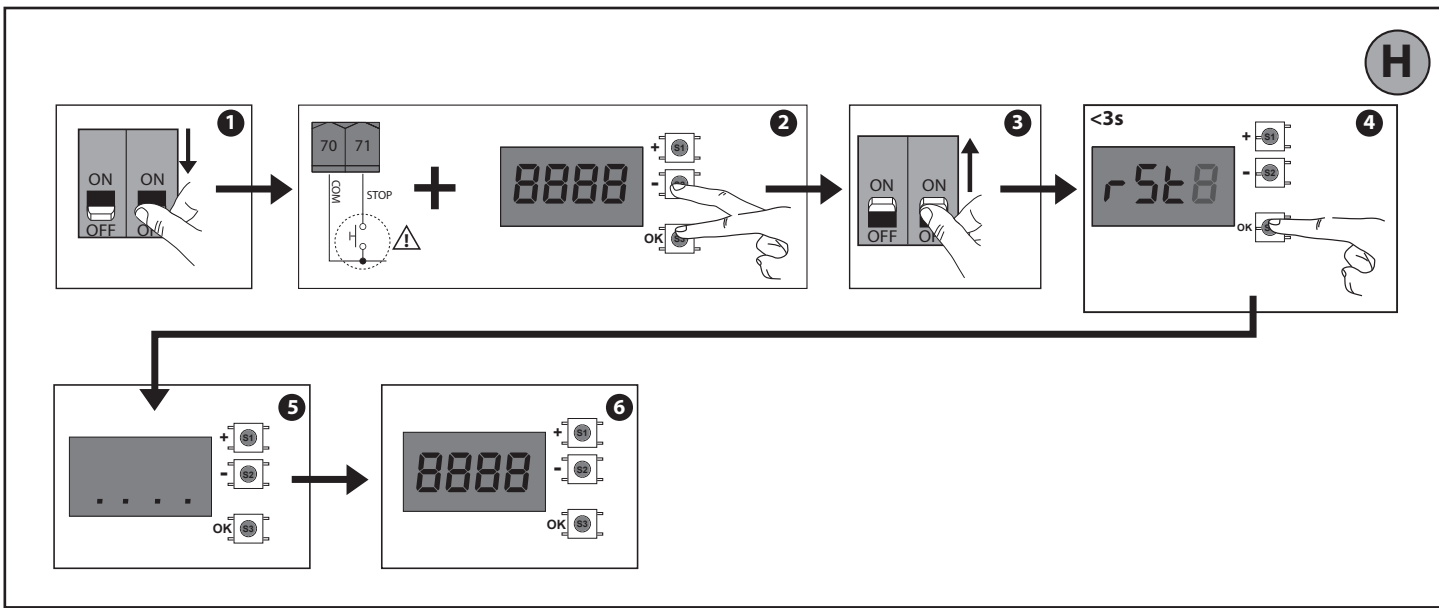
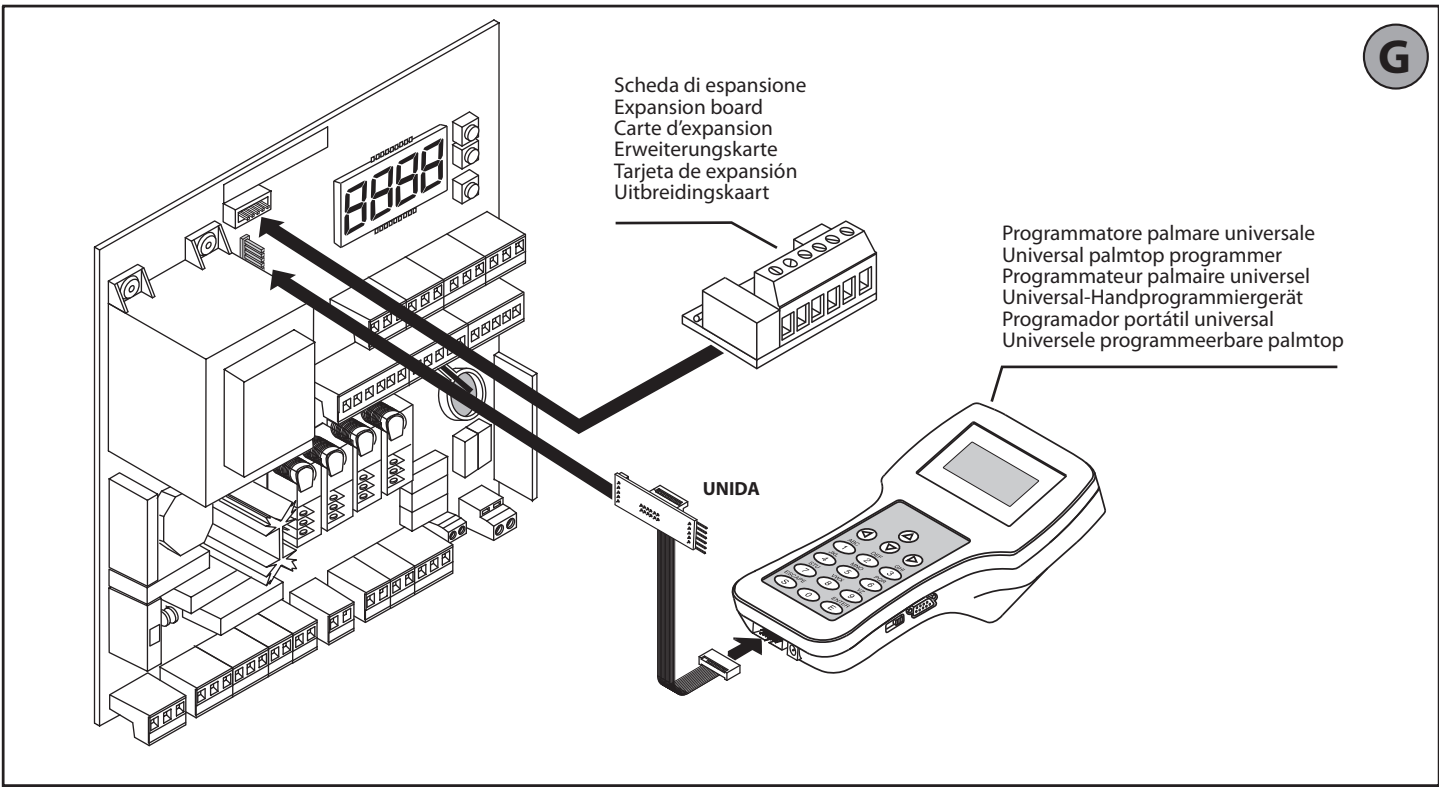
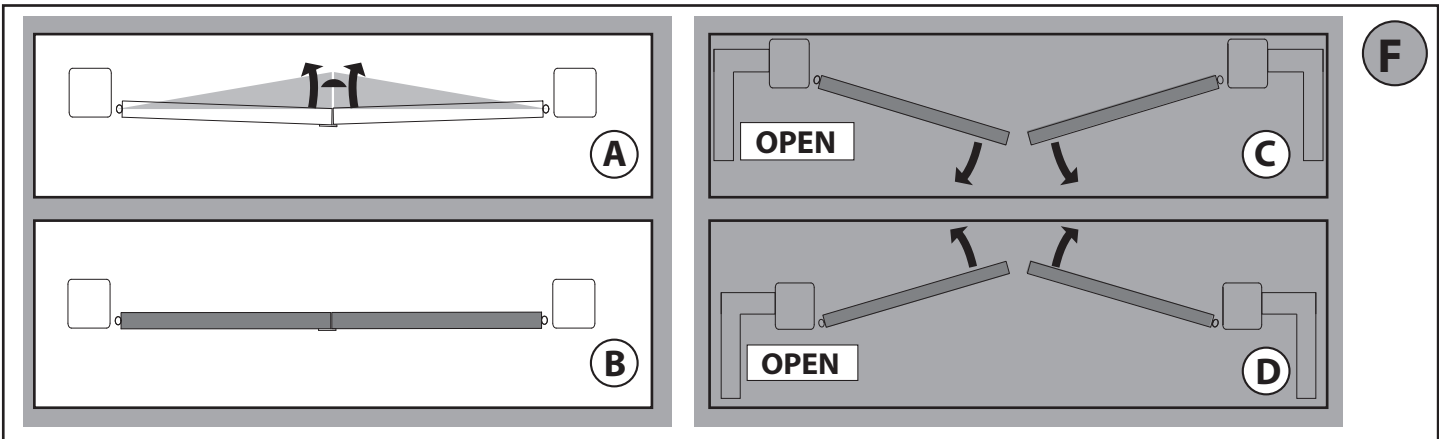

**PROGRAMMAZIONE MENÙ CHRONO - CHRONO MENU PROGRAMMING - CHRONO MENU PROGRAMMING  
PROGRAMMIERUNG MENÜ CHRONO - PROGRAMACIÓN MENÜ CHRONO - PROGRAMMERING CHRONO-MENU**

I

I valori sono programmabili a step di 10 minuti - Values are programmable in 10 minutes' steps  
Les valeurs sont programmables par étape de 10 minutes - Die Werte können in Schritten von 10 Minuten programmiert werden  
Los valores se puede programar con intervalos de 10 minutos - De waarden zijn programmeerbaar met stappen van 10 minuten

	Lunedì Monday Lundi Montag Lunes Maandag	Martedì Tuesday Mardi Dienstag Martes Dinsdag	Mercoledì Wednesday Mercredi Mittwoch Miércoles Woensdag	Giovedì Thursday Jeudi Donnerstag Jueves Donderdag	Venerdì Friday Vendredi Freitag Viernes Vrijdag	Sabato Saturday Samedi Samstag Sábado Zaterdag	Domenica Sunday Dimanche Sonntag Domingo Zondag
00:00							
01:00							
02:00							
03:00							
04:00							
05:00							
06:00							
07:00							
08:00							
09:00							
10:00							
11:00							
12:00							
13:00							
14:00							
15:00							
16:00							
17:00							
18:00							
19:00							
20:00							
21:00							
22:00							
23:00							

	Lunedì Monday Lundi Montag Lunes Maandag	Martedì Tuesday Mardi Dienstag Martes Dinsdag	Mercoledì Wednesday Mercredi Mittwoch Miércoles Woensdag	Giovedì Thursday Jeudi Donnerstag Jueves Donderdag	Venerdì Friday Vendredi Freitag Viernes Vrijdag	Sabato Saturday Samedi Samstag Sábado Zaterdag	Domenica Sunday Dimanche Sonntag Domingo Zondag
Fascia 1 Time band 1 Tranche 1 Zeitraum 1 Franja 1 Bereik 1	Inizio / Beginning Début / Beginn Inicio / Begin 07.00	Inizio / Beginning Début / Beginn Inicio / Begin 07.00	Inizio / Beginning Début / Beginn Inicio / Begin 06.00	Inizio / Beginning Début / Beginn Inicio / Begin 07.00	Inizio / Beginning Début / Beginn Inicio / Begin 07.00	Inizio / Beginning Début / Beginn Inicio / Begin 10.00	Inizio / Beginning Début / Beginn Inicio / Begin 10.00
	Fine / End Fin / Ende Final / Einde 12.00	Fine / End Fin / Ende Final / Einde 12.00	Fine / End Fin / Ende Final / Einde 12.00	Fine / End Fin / Ende Final / Einde 12.00	Fine / End Fin / Ende Final / Einde 12.00	Fine / End Fin / Ende Final / Einde 12.00	Fine / End Fin / Ende Final / Einde 12.00
Fascia 2 Time band 2 Tranche 2 Zeitraum 2 Franja 2 Bereik 2	Inizio / Beginning Début / Beginn Inicio / Begin 14.00	Inizio / Beginning Début / Beginn Inicio / Begin 00.00	Inizio / Beginning Début / Beginn Inicio / Begin 14.00	Inizio / Beginning Début / Beginn Inicio / Begin 00.00	Inizio / Beginning Début / Beginn Inicio / Begin 14.00	Inizio / Beginning Début / Beginn Inicio / Begin 00.00	Inizio / Beginning Début / Beginn Inicio / Begin 00.00
	Fine / End Fin / Ende Final / Einde 18.00	Fine / End Fin / Ende Final / Einde 00.00	Fine / End Fin / Ende Final / Einde 18.00	Fine / End Fin / Ende Final / Einde 00.00	Fine / End Fin / Ende Final / Einde 18.00	Fine / End Fin / Ende Final / Einde 00.00	Fine / End Fin / Ende Final / Einde 00.00

Fascia non programmata. Viene lasciata a 0  
No scheduled time zone. It is left at 0  
Tranche non programmée. Est laissée à 0  
Zeitraum nicht programmiert. Wird auf 0 gelassen  
Franja no programada. Se deja en 0  
Niet geprogrammeerd bereik Wordt losgelaten op 0

ITALIANO

ENGLISH

FRANÇAIS

DEUTSCH

ESPAÑOL

NEDERLANDS



# ACCESS MENUS Fig. 1

D812865 00100\_04

\*\*\* Password entry.  
Request with Protection Level  
logic set to 1, 2, 3, 4

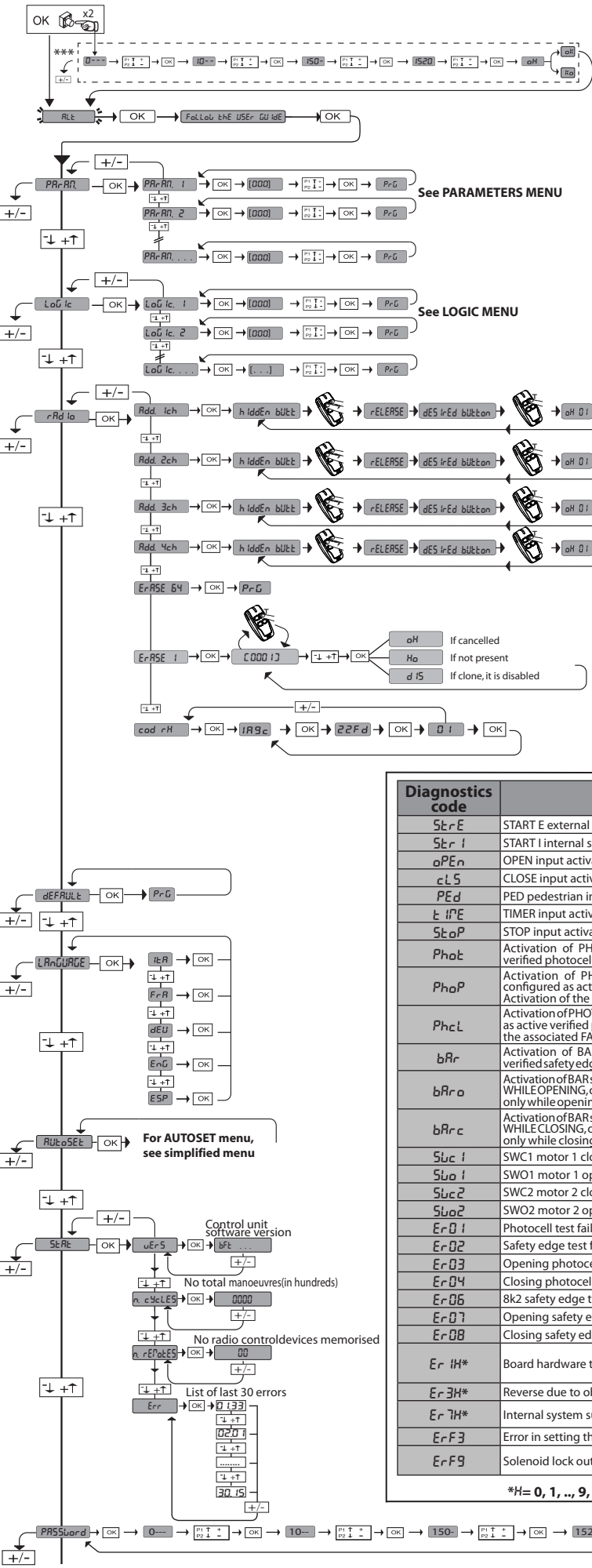

**LEGENDA**

+ ↑

- ↓

OK ↵

Scroll up

Scroll down

Confirm/Switch on display

+ ⊗

- ⊗

Exit Menü

Diagnostics code	DESCRIPTION	NOTES
StrE	START E external start input activated	
Str I	START I internal start input activated	
oPEn	OPEN input activated	
cLS	CLOSE input activated	
PEd	PED pedestrian input activated	
t iPE	TIMER input activation or activation time band	
StoP	STOP input activated	
Phot	Activation of PHOT photocell input or, if configured as verified photocell, Activation of the associated FAULT input	
PhoP	Activation of PHOT OP opening photocell input or, if configured as active verified photocell only when opening, Activation of the associated FAULT input	
PhcL	Activation of PHOT CL closing photocell input or, if configured as active verified photocell only when closing, Activation of the associated FAULT input	
bRr	Activation of BAR safety edge input or, if configured as verified safety edge, Activation of the associated FAULT input	
bRro	Activation of BAR safety edge input with ACTIVE reversal ONLY WHILE OPENING, or, if configured as verified safety edge active only while opening, Activation of the associated FAULT input	
bRrc	Activation of BAR safety edge input with ACTIVE reversal ONLY WHILE CLOSING, or, if configured as verified safety edge active only while closing, Activation of the associated FAULT input	
Suc 1	SWC1 motor 1 closing limit switch input activated	
Suo 1	SWO1 motor 1 opening limit switch input activated	
Suc 2	SWC2 motor 2 closing limit switch input activated	
Suo 2	SWO2 motor 2 opening limit switch input activated	
Er 01	Photocell test failed	Check photocell connection and/or logic settings
Er 02	Safety edge test failed	Check safety edge connection and/or logic settings
Er 03	Opening photocell test failed	Check photocell connection and/or parameter/logic setting
Er 04	Closing photocell test failed	Check photocell connection and/or parameter/logic setting
Er 06	8k2 safety edge test failed	Check safety edge connection and/or parameter/logic settings
Er 07	Opening safety edge test failed	Check safety edge connection and/or parameter/logic settings
Er 08	Closing safety edge test failed	Check safety edge connection and/or parameter/logic settings
Er 1H*	Board hardware test error	- Check connections to motor - Hardware problems with board (contact technical assistance)
Er 3H*	Reverse due to obstacle - Amperostop	Check for obstacles in path
Er 7H*	Internal system supervision control error.	Try switching the board off and back on again. If the problem persists, contact the technical assistance department.
Er F3	Error in setting the SAFE inputs	Check the setting of the SAFE inputs is correct
Er F9	Solenoid lock output overload	- Check lock connections - Unsuitable lock

\*H= 0, 1, ..., 9, A, B, C, D, E, F

# ACCESS MENUS Fig. 1

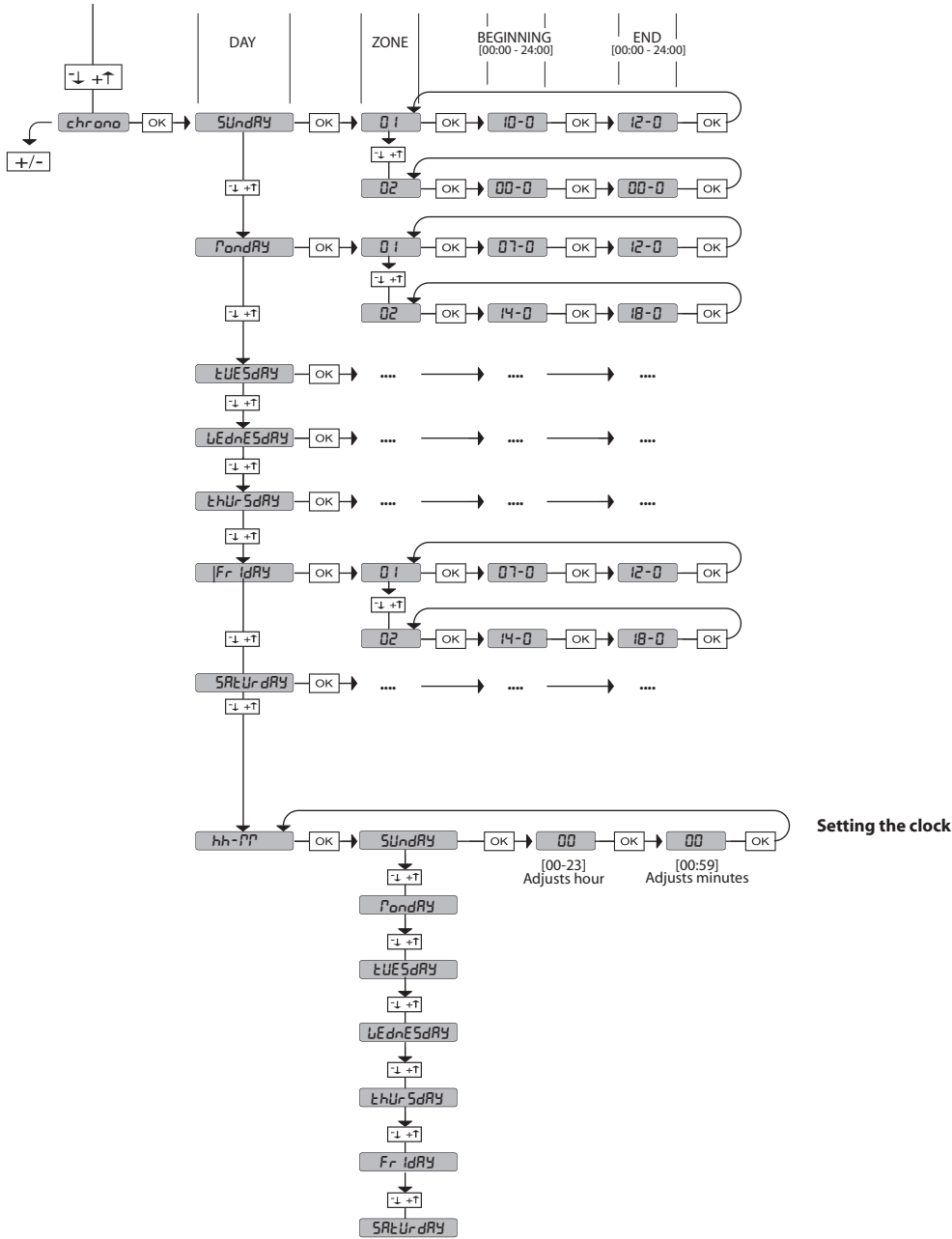

# INSTALLATION MANUAL

## 2) GENERAL INFORMATION

The **RIGEL 6** control panel comes with standard factory settings. Any change must be made using the programmer with built-in display or universal handheld programmer. The Control unit completely supports the EELINK protocol.

Its main features are:

- Check of 1 or 2 single-phase motors fitted with thermostat
- Control of 1 or 2 single phase motors
- Note: 2 motors of the same type must be used.
- Opening/closing limit switch control inputs, separate for each motor
- Separate inputs for safety devices
- Time band management
- Integrated obstacle detection
- Motor pre-heating with integrated sensor reading
- Adjustable electrodynamic braking
- Approach speed slow-down
- Built-in radio receiver rolling code with transmitter cloning.

The board has a terminal strip of the removable kind to make maintenance or replacement easier. It comes with a series of prewired jumpers to make the installer's job on site easier.

**The jumpers concern terminals: 41-42, 41-43, 41-44, 41-45, 70-71, 70-72, 70-74, 76-77, 76-79, 81-82, 81-84. If the above-mentioned terminals are being used, remove the relevant jumpers.**

## TESTING

The **RIGEL 6** panel controls (checks) the run relays, triacs and safety devices (photo-cells and edges), before performing each opening and closing cycle.

If there is a malfunction, make sure that the connected devices are working properly and check the wiring.

**ATTENTION!** if the leaf is installed in a public area or if an automatic operating mode is enabled, we recommend a pair of photocells is installed at a height of 5 cm together with another pair at a height of 40-50 cm. Automatic mode means any control not voluntarily activated by the user (example: TCA function, chrono, etc.)

AUX 3	NO contact (Max 24V~)	10W MAX
LOCK	Output for 12V~ solenoid lock:	10W MAX
Dimensions	see <b>Fig. B</b>	
Fuses	see <b>Fig. C</b>	
N° of combinations	4 billion	
Max,n° of transmitters that can be memorized	63	

(\*other voltages to order)

Use cycle	continuous	continuous	1 min. ON/ 2 min. OFF	1 min. ON/ 2 min. OFF
Operating temperature range	-20°C/+50°C	-20°C/+55°C	-20°C/+50°C	-20°C/+55°C
Maximum motor power 220-230V	2x375 W 1x750 W	2x250 W 1x500 W	2x650 W 1x750 W	2x500 W 1x750 W
Maximum motor power 110-120V	2x320 W 1x390 W			

**⚠ M1+M2+AUX0+AUX1+AUX2+AUX3+LOCK = 1300W MAX T=+50°C**

**Usable transmitter versions:**

**All ROLLING CODE transmitters compatible with ((€R-Ready))**

## 4) TUBE ARRANGEMENT Fig. A

## 5) TERMINAL BOARD WIRING Fig. C

**WARNINGS** - When performing wiring and installation, refer to the standards in force and, whatever the case, apply good practice principles.

Wires carrying different voltages must be kept physically separate from each other, or they must be suitably insulated with at least 1mm of additional insulation. Wires must be secured with additional fastening near the terminals, using devices such as cable clamps.

All connecting cables must be kept far enough away from the dissipater.

3) TECHNICAL SPECIFICATIONS		
Power supply	220-230V 50/60Hz(*)	
Low voltage/mains insulation	> 2MΩ 500V ~~~	
Dielectric rigidity	mains/LV 3750V~ for 1 minute	
Accessories power supply	24V~ (demand max. 1A) 24V~safe	
AUX 0	NO 220-230V~ (80W MAX) powered contact	⚠ AUX0+ AUX1+ AUX2= 80W MAX
AUX 1	NO 220-230V~ (80W MAX) powered contact	
AUX 2	NO contact (MAX 220-230V~ 80W)	

	Terminal	Definition	Description
Power supply	L	LINE	Single-phase power supply 220-230V 50/60Hz(*)
	N	NEUTRAL	
	GND	EARTH	
Motor	10	MOT1 RUN	Connection motor 1. Time lag during closing.
	11	MOT 1 COM	
	12	MOT1 RUN	
	14	MOT2 RUN	Connection motor 2. Time lag during opening.
	15	MOT 2 COM	
	16	MOT2 RUN	
		⚠ Note: if " ! P o t . o n . " = 1 do not connect any wires to terminals 14-15-16	
Aux	20	AUX 1 - 220-230V~ POWERED CONTACT	AUX 0 configurable output - Default setting FLASHING LIGHT. MONOSTABLE RADIO CHANNEL/ SCA GATE OPEN LIGHT/ COURTESY LIGHT command/ ZONE LIGHT command/ STAIR LIGHT/ GATE OPEN ALARM/ FLASHING LIGHT/ SOLENOID LATCH/ MAGNETIC LOCK/ MAINTENANCE/ FLASHING LIGHT AND MAINTENANCE / GATE STATUS / BISTABLE RADIO CHANNEL / TIMED RADIO CHANNEL. Refer to "AUX output configuration" table.
	21	⚠	
	22	AUX 1 - 220-230V~ POWERED CONTACT	AUX 1 configurable output - Default setting ZONE LIGHT Output. MONOSTABLE RADIO CHANNEL/ SCA GATE OPEN LIGHT/ COURTESY LIGHT command/ ZONE LIGHT command/ STAIR LIGHT/ GATE OPEN ALARM/ FLASHING LIGHT/ SOLENOID LATCH/ MAGNETIC LOCK/ MAINTENANCE/ FLASHING LIGHT AND MAINTENANCE / GATE STATUS / BISTABLE RADIO CHANNEL / TIMED RADIO CHANNEL. Refer to "AUX output configuration" table.
	23	⚠	
	24	AUX 2 - FREE CONTACT (N.O.)	AUX 2 configurable output - Default setting SCA GATE OPEN LIGHT Output. MONOSTABLE RADIO CHANNEL/ SCA GATE OPEN LIGHT/ COURTESY LIGHT command/ ZONE LIGHT command/ STAIR LIGHT/ GATE OPEN ALARM/ FLASHING LIGHT/ SOLENOID LATCH/ MAGNETIC LOCK/ MAINTENANCE/ FLASHING LIGHT AND MAINTENANCE / GATE STATUS / BISTABLE RADIO CHANNEL / TIMED RADIO CHANNEL. Refer to "AUX output configuration" table.
	25		
	26	AUX 3 - FREE CONTACT (N.O.)	AUX 3 configurable output - Default setting MONOSTABLE RADIO CHANNEL Output. MONOSTABLE RADIO CHANNEL/ SCA GATE OPEN LIGHT/ COURTESY LIGHT command/ ZONE LIGHT command/ STAIR LIGHT/ GATE OPEN ALARM/ FLASHING LIGHT/ SOLENOID LATCH/ MAGNETIC LOCK/ MAINTENANCE/ FLASHING LIGHT AND MAINTENANCE / GATE STATUS / BISTABLE RADIO CHANNEL / TIMED RADIO CHANNEL. Refer to "AUX output configuration" table.
	27		
	28	LOCK 12V ~~~	Type of lock logic= 0 - 12V~ solenoid latch output. Output activated with a pulse each time gate is opened or closed <b>(MODEL ECB)</b>
	29		Type of lock logic= 1 - 12V~ magnetic lock output. Output activated when gate is closed or closing
Limit switch	40		Not used
	41	+ REF SWE	Limit switch common
	42	SWC 1	Motor 1 closing limit switch SWC1 (N.C.).
	43	SWO 1	Motor 1 opening limit switch SWO1 (N.C.).
	44	SWC 2	Motor 2 closing limit switch SWC2 (N.C.).
	45	SWO 2	Motor 2 opening limit switch SWO2 (N.C.).
Accessories power supply	50	24V-	Accessories power supply output.
	51	24V+	
	52	24Vsafe+	Tested safety device power supply output (photocell transmitter and safety edge transmitter). Output active only during operating cycle.

# INSTALLATION MANUAL

	Terminal	Definition	Description
<b>Commands</b>	60	Common	IC 1 and IC 2 inputs common
	61	IC 1	Configurable command input 1 (N.O.) - Default START E. START E / START I / OPEN / CLOSE / PED / TIMER / TIMER PED Refer to the "Command input configuration" table.
	62	IC 2	Configurable command input 2 (N.O.) - Default PED. START E / START I / OPEN / CLOSE / PED / TIMER / TIMER PED Refer to the "Command input configuration" table.
	63	Common	IC 3 and IC 4 inputs common
	64	IC 3	Configurable command input 3 (N.O.) - Default OPEN. START E / START I / OPEN / CLOSE / PED / TIMER / TIMER PED Refer to the "Command input configuration" table.
	65	IC 4	Configurable command input 4 (N.O.) - Default CLOSE. START E / START I / OPEN / CLOSE / PED / TIMER / TIMER PED Refer to the "Command input configuration" table.
<b>Safety devices</b>	70	Common	STOP, SAFE 1 and SAFE 2 inputs common
	71	STOP	The command stops movement. (N.C.) If not used, leave jumper inserted.
	72	SAFE 1	Configurable safety input 1 (N.C.) - Default PHOT. PHOT / PHOT TEST / PHOT OP / PHOT OP TEST / PHOT CL / PHOT CL TEST / BAR / BAR TEST / BAR 8K2 / BAR OP / BAR OP TEST / BAR 8K2 OP / BAR CL / BAR CL TEST / BAR 8K2 CL. Refer to the "Safety input configuration" table.
	73	FAULT 1	Test input for safety devices connected to SAFE 1.
	74	SAFE 2	Configurable safety input 2 (N.C.) - Default BAR. PHOT / PHOT TEST / PHOT OP / PHOT OP TEST / PHOT CL / PHOT CL TEST / BAR / BAR TEST / BAR 8K2 / BAR OP / BAR OP TEST / BAR 8K2 OP / BAR CL / BAR CL TEST / BAR 8K2 CL. Refer to the "Safety input configuration" table.
	75	FAULT 2	Test input for safety devices connected to SAFE 2.
	76	Common	SAFE 3 and SAFE 4 inputs common
	77	SAFE 3	Configurable safety input 3 (N.C.) - Default PHOT OP. PHOT / PHOT TEST / PHOT OP / PHOT OP TEST / PHOT CL / PHOT CL TEST / BAR / BAR TEST / BAR OP / BAR OP TEST / BAR CL / BAR CL TEST / Refer to the "Safety input configuration" table.
	78	FAULT 3	Test input for safety devices connected to SAFE 3.
	79	SAFE 4	Configurable safety input 4 (N.C.) - Default PHOT CL. PHOT / PHOT TEST / PHOT OP / PHOT OP TEST / PHOT CL / PHOT CL TEST / BAR / BAR TEST / BAR OP / BAR OP TEST / BAR CL / BAR CL TEST / Refer to the "Safety input configuration" table.
	80	FAULT 4	Test input for safety devices connected to SAFE 4.
	81	Common	SAFE 5 and SAFE 6 inputs common
	82	SAFE 5	Configurable safety input 5 (N.C.) - Default PHOT. PHOT / PHOT TEST / PHOT OP / PHOT OP TEST / PHOT CL / PHOT CL TEST / BAR / BAR TEST / BAR OP / BAR OP TEST / BAR CL / BAR CL TEST / Refer to the "Safety input configuration" table.
	83	FAULT 5	Test input for safety devices connected to SAFE 5.
84	SAFE 6	Configurable safety input 6 (N.C.) - Default BAR. PHOT / PHOT TEST / PHOT OP / PHOT OP TEST / PHOT CL / PHOT CL TEST / BAR / BAR TEST / BAR OP / BAR OP TEST / BAR CL / BAR CL TEST / Refer to the "Safety input configuration" table.	
85	FAULT 6	Test input for safety devices connected to SAFE 6.	
<b>Antenna</b>	Y	ANTENNA	Antenna input.
	#	SHIELD	Use an antenna tuned to 433MHz. Use RG58 coax cable to connect the Antenna and Receiver. Metal bodies close to the antenna can interfere with radio reception. If the transmitter's range is limited, move the antenna to a more suitable position.
<b>NTC</b>		NTC	Input for temperature sensor connection

## AUX output configuration

Aux logic= 0 - MONOSTABLE RADIO CHANNEL output.

Contact stays closed for 1s when radio channel is activated.

Aux logic= 1 - SCA GATE OPEN LIGHT output.

Contact stays closed during opening and with leaf open, intermittent during closing, open with leaf closed.

Aux logic= 2 - COURTESY LIGHT command output.

Contact stays on for 90 seconds after the last operation.

Aux logic= 3 - ZONE LIGHT command output.

Contact stays closed for the full duration of operation.

Aux logic= 4 - STAIR LIGHT output.

Contact stays closed for 1 second at start of operation.

Aux logic= 5 - GATE OPEN ALARM output.

Contact stays closed if the leaf stays open for double the set TCA time.

Aux logic= 6 - FLASHING LIGHT output.

Contact stays closed while leaves are operating.

Aux logic= 7 - SOLENOID LATCH output.

Contact stays closed for 2 seconds each time gate is opened or closed.

Aux logic= 8 - MAGNETIC LOCK output.

Contact stays closed when gate is closed and while it is closing.

Aux logic= 9 - MAINTENANCE output.

Contact stays closed once the value set for the Maintenance parameter is reached, to report that maintenance is required.

Aux logic= 10 - FLASHING LIGHT AND MAINTENANCE output.

Contact stays closed while leaves are operating. If the value set for the Maintenance parameter is reached, once the gate has finished moving and the leaf is closed, the contact closes for 10 sec. and opens for 5 sec. 4 times to report that maintenance is required.

# INSTALLATION MANUAL

D812865 00100\_04

## AUX output configuration

Aux logic= 11 - Not available

Aux logic= 12 - Not available

Aux logics= 13 - GATE STATUS output  
Contact stays closed while gate is closed.

AUX logics= 14 - BISTABLE RADIO CHANNEL output  
The contact changes status (open-closed) when the radio channel is activated

AUX logics= 15 - TIMED RADIO CHANNEL output  
The contact remains closed for a programmable length of time when the radio channel is activated (output time)  
If, during this time, the button is pressed again, counting starts all over again.

## Command input configuration

IC logic= 0 - Input configured as Start E. Operation according to 5tEP-bY-5tEP P<sub>au</sub>. logic. External start for traffic light control.

IC logic= 1 - Input configured as Start I. Operation according to 5tEP-bY-5tEP P<sub>au</sub>. logic. Internal start for traffic light control.

IC logic= 2 - Input configured as Open.  
The command causes the leaves to open. If the input stays closed, the leaves stay open until the contact is opened. When the contact is open, the automated device closes following the TCA time, where activated.

IC logic= 3 - Input configured as Closed.  
The command causes the leaves to close.

IC logic= 4 - Input configured as Ped.  
The command causes the leaf to open to the pedestrian (partial) opening position. Operation according to 5tEP-bY-5tEP. logic

IC logic= 5 - Input configured as Timer.  
Operation same as open except closing is guaranteed even after a mains power outage.

IC logic= 6 - Input configured as Timer Ped.  
The command causes the leaf to open to the pedestrian (partial) opening position. If the input stays closed, the leaf stays open until the contact is opened. If the input stays closed and a Start E, Start I or Open command is activated, a complete opening-closing cycle is performed before returning to the pedestrian opening position. Closing is guaranteed even after a mains power outage.

## Safety input configuration

SAFE logic= 0 - Input configured as Phot (photocell) non tested (\*). (fig.F, ref.1).  
Enables connection of devices not equipped with supplementary test contacts. When beam is broken, photocells are active during both opening and closing. When beam is broken during closing, movement is reversed only once the photocell is cleared. If not used, leave jumper inserted.

SAFE logic= 1 - Input configured as Phot test (tested photocell). (fig.F, ref.2).  
Switches photocell testing on at start of operation. When beam is broken, photocells are active during both opening and closing. When beam is broken during closing, movement is reversed only once the photocell is cleared.

SAFE logic= 2 - Input configured as Phot op (photocell active during opening only) non tested (\*). (fig.F, ref.1).  
Enables connection of devices not equipped with supplementary test contacts. In the event beam is broken, photocell operation is disabled during closing. During opening, stops motion for as long as the photocell beam stays broken. If not used, leave jumper inserted.

SAFE logic= 3 - Input configured as Phot op test (tested photocell active during opening only) (fig.F, ref.2).  
Switches photocell testing on at start of operation. In the event beam is broken, photocell operation is disabled during closing. During opening, stops motion for as long as the photocell beam stays broken.

SAFE logic= 4 - Input configured as Phot cl (photocell active during closing only) non tested (\*). (fig.F, ref.1).  
Enables connection of devices not equipped with supplementary test contacts. In the event beam is broken, photocell operation is disabled during opening. During closing, movement is reversed immediately. If not used, leave jumper inserted.

SAFE logic= 5 - Input configured as Phot cl test (tested photocell active during closing only) (fig.F, ref.2).  
Switches photocell testing on at start of operation. In the event beam is broken, photocell operation is disabled during opening. During closing, movement is reversed immediately.

SAFE logic= 6 - Input configured as Bar (safety edge) non tested (\*). (fig.F, ref.3).  
Enables connection of devices not equipped with supplementary test contacts. The command reverses movement for 2 sec.. If not used, leave jumper inserted.

SAFE logic= 7 - Input configured as Bar (tested safety edge) (fig.F, ref.4).  
Switches safety edge testing on at start of operation. The command reverses movement for 2 sec.

SAFE logic= 8 - Input configured as Bar 8k2 (fig.F, ref.5). Input for resistive edge 8K2.  
The command reverses movement for 2 sec.

SAFE logic=9 Input configured as Bar op, safety edge with active inversion only while opening, if activated while closing, the automation stops (STOP) (Fig. F, ref. 3).  
Allows connecting devices not fitted with supplementary test contact. The operation while opening causes the movement to be reversed for 2 seconds, the operation while closing causes the automation to stop. If not used, leave jumper inserted.

SAFE logic=10 Input configured as Bar op test, safety edge checked with active inversion only while opening, if activated while closing, the automation stops (STOP) (Fig. F, ref. 4).  
Activates testing safety edges when starting operation. The operation while opening causes the movement to be reversed for 2 seconds, the operation while closing causes the automation to stop.

SAFE logic=11 Input configured as Bar 8k2 op, 8k2 safety edge with active inversion only while opening, if activated while closing, the automation stops (STOP) (Fig. F, ref. 5).  
The operation while opening causes the movement to be reversed for 2 seconds, the operation while closing causes the automation to stop.

SAFE logic=12 Input configured as Bar cl, safety edge with active inversion only while closing, if activated while opening, the automation stops (STOP) (Fig. F, ref. 3).  
Allows connecting devices not fitted with supplementary test contact. The operation while closing causes the movement to be reversed for 2 seconds, the operation while opening causes the automation to stop. If not used, leave jumper inserted.

SAFE logic=13 Input configured as Bar cl test, safety edge checked with active inversion only while closing, if activated while opening, the automation stops (STOP) (Fig. F, ref. 4).  
Activates testing safety edges when starting operation. The operation while closing causes the movement to be reversed for 2 seconds, the operation while opening causes the automation to stop.

SAFE logic=14 Input configured as Bar 8k2 cl, safety edge with active inversion only while closing, if activated while opening, the automation stops (STOP) (Fig. F, ref. 5).  
The operation while closing causes the movement to be reversed for 2 seconds, the operation while opening causes the automation to stop.

**(\*) If "D" type devices are installed (as defined by EN12453), connect in unverified mode, foresee mandatory maintenance at least every six months.**

**6) SAFETY DEVICES**

**Note: only use receiving safety devices with free changeover contact.**

**6.1) TESTED DEVICES Fig. F****6.2) CONNECTION OF 1 PAIR OF NON-TESTED PHOTOCELLS FIG. D****7) CALLING UP MENUS: FIG. 1****7.1) PARAMETERS MENU (PARAMETERS TABLE "A")****7.2) LOGIC MENU (LOGIC TABLE "B")****7.3) RADIO MENU (RADIO TABLE "C")**

**IMPORTANT NOTE: THE FIRST TRANSMITTER MEMORIZED MUST BE IDENTIFIED BY ATTACHING THE KEY LABEL (MASTER).**

In the event of manual programming, the first transmitter assigns the RECEIVER'S KEY CODE: this code is required to subsequently clone the radio transmitters.

The Clonix built-in on-board receiver also has a number of important advanced features:

- Cloning of master transmitter (rolling code or fixed code).
- Cloning to replace transmitters already entered in receiver.
- Transmitter database management.
- Receiver community management.

To use these advanced features, refer to the universal handheld programmer's instructions and to the general receiver programming guide.

If a 4-channel remote control is used, keep one for the STOP function.

**7.4) DEFAULT MENU (DEFAULT)**

Restores the controller's DEFAULT factory settings. Following this reset, you will need to run the AUTOSET function again.

**7.5) LANGUAGE MENU (LANGUAGE)**

Used to set the programmer's language on the display.

**7.6) AUTOSET MENU (AUTOSET)**

Autoset for motors with limit switches (Fig. E1):

- 1 - Place the leaves at the closing limit switch.
- 2 - Start an autoset from the relative menu, press the OK button start motor 1's opening manoeuvre.
- 3 - The display shows "M1.o".
- 4 - Wait for the opening limit switch to be triggered to finish motor 1's opening manoeuvre.
- 5 - Motor 2 starts opening automatically. A displays "M2.o".
- 6 - Wait for the opening limit switch to be triggered to finish motor 2's opening manoeuvre, the display shows the message "CLOSE".
- 7 - Press the OK button to start motor 2's closing manoeuvre. A displays "M2.c".
- 8 - Wait for the closing limit switch to be triggered to finish motor 2's closing manoeuvre.
- 9 - Motor 1 starts closing automatically. A displays "M1.c".
- 10 - Wait for the closing limit switch to be triggered to finish motor 1's closing manoeuvre.
- If the work time has been stored correctly, the display shows "OPEN".
- 11 - Press the OK button to start the second cycle and calculate the torque value required for the leaf/ves to move, the display shows "M1.o".
- 12 - Wait for the opening limit switch to be triggered to finish motor 1's opening manoeuvre.
- 13 - Motor 2 starts opening automatically. A displays "M2.o".
- 14 - Wait for the opening limit switch to be triggered to finish motor 2's opening manoeuvre, the display shows the message "CLOSE".
- 15 - Press the OK button to start motor 2's closing manoeuvre. A displays "M2.c".
- 16 - Wait for the closing limit switch to be triggered to finish motor 2's closing manoeuvre.
- 17 - Motor 1 starts closing automatically. A displays "M1.c".
- 18 - Wait for the closing limit switch to be triggered to finish motor 1's closing manoeuvre.
- 19 - If the autoset has completed correctly, the display shows "OK", if autoset fails, the display shows the message "KO" and the operation must be repeated from phase 1.

If motor 1 is set to active, the phases relative to motor 2 are not performed.

Autoset for motors with no limit switches (Fig. E2):

- 1 - Place the leaves at the closing stops.
- 2 - start an autoset from the relative menu, pressing the OK button start motor 1's opening manoeuvre.
- 3 - The display shows "M1.o".
- 4 - Press the OK button to finish motor 1's opening manoeuvre. A displays "M2.o".
- 5 - Motor 2 starts opening automatically.
- 6 - Press the OK button to finish motor 2's opening manoeuvre, the display shows "CLOSE".
- 7 - Press the OK button to start motor 2's closing manoeuvre. A displays "M2.c".
- 8 - Press the OK button to finish motor 2's closing manoeuvre. A displays "M1.c".
- 9 - Motor 1 starts closing automatically.
- 10 - Press the OK button to finish motor 1's closing manoeuvre.
- If the work time has been stored correctly, the display shows "OPEN".
- 11 - Press the OK button to start the second cycle and calculate the torque value required for the leaf/ves to move, the display shows "M1.o".
- 12 - Wait for motor 1's work time to intervene to finish motor 1's opening manoeuvre.
- 13 - Motor 2 starts opening automatically. A displays "M2.o".
- 14 - Wait for Motor 2's work time to intervene to finish motor 2's opening manoeuvre, the display shows the message "CLOSE".
- 15 - Press the OK button to start motor 2's closing manoeuvre. A displays "M2.c".
- 16 - Wait for motor 2's work time to intervene to finish motor 2's closing manoeuvre.
- 17 - Motor 1 starts closing automatically. A displays "M1.c".
- 18 - Wait for motor 1's work time to intervene to finish motor 1's closing manoeuvre.
- 19 - If the autoset has completed correctly, the display shows "OK", if autoset fails, the display shows the message "KO" and the operation must be repeated from phase 1.

If motor 1 is set to active, the phases relative to motor 2 are not performed.

During this stage, it is important to avoid breaking the photocells' beams, causing the safety devices to intervene, and not to use the START, STOP, OPEN and CLOSE controls or the display.

Once this operation is completed, the control unit will have automatically set the optimum parameters and work times. Check them and, where necessary,

edit them as described in the programming section.



**WARNING!! Check that the force of impact measured at the points provided for by standard EN 12445 is lower than the value laid down by standard EN 12453.**



**The impact forces must be limited with the use of active coasts accordance with EN12978.**



**Warning!! While the autoset function is running, the obstacle detection function is not active. Consequently, the installer must monitor the automated system's movements and keep people and property out of range of the automated system.**

**7.7) INSTALLATION TEST PROCEDURE**

1. Apply pressure-sensitive or electro-sensitive protective devices (such as a safety edge)
  2. Run the AUTOSET cycle (\*)
  3. Check the impact forces: if they fall within the limits. Skip to point 5 of the procedure, otherwise
  4. Allow the drive to move only in "Deadman" mode
  5. Make sure all devices designed to detect obstacles within the system's operating range are working properly
- (\*) Before running the autoset function, make sure you have performed all the assembly and make-safe operations correctly, as set out in the installation warnings in the drive's manual and have set the opening/closing strength, slow-down and slow-down time parameters.

**7.8) STATISTICS MENU**

Used to view the version of the board, the total number of operations (in hundreds), the number of transmitters memorized and the last 30 errors (the first 2 digits indicate the position, the last 2 give the error code). Error 01 is the most recent.

**7.9) PASSWORD MENU**

Used to set a password for the board's wireless programming via the U-link network. With "PROTECTION LEVEL" logic set to 1,2,3,4, the password is required to access the programming menus. After 10 consecutive failed attempts to log in, you will need to wait 3 minutes before trying again. During this time, whenever an attempt is made to log in, the display will read "BLOC". The default password is 1234.

**7.10) CHRONO MENU Fig.J**

Allows setting the operation by time bands.

Up to two daily time bands during which the gate remains open (from Monday to Sunday) can be set.

Within the time slot opening of the doors is performed that remain open until the end of the time slot.

**8) CLOSING LIMIT SWITCH PRESSURE Fig. G Ref. A-B  
OPENING DIRECTION Fig. G Ref. C-D****9) CONNECTION WITH EXPANSION BOARDS AND UNIVERSAL HANDHELD PROGRAMMER.** Refer to specific manual.**10) U-LINK OPTIONAL MODULES**

Refer to the U-link instructions for the modules.

The use of some models causes lowered radio capacity. Adjust the system using an appropriate antenna tuned to 433MHz.

**11) RESTORING FACTORY SETTINGS (Fig.I)**

**WARNING:** this operation will restore the control unit's factory settings and all transmitters stored in its memory will be deleted.

**WARNING!** Incorrect settings can result in damage to property and injury to people and animals.

- Cut off power to the board (Fig.I ref.1)
- Open the Stop input and press the - and OK keys together (Fig.I ref.2)
- Switch on the board's power (Fig.I ref.3)
- The display will read RST; confirm within 3 sec. by pressing the OK key (Fig.I ref.4)
- Wait for the procedure to finish (Fig.I ref.5)
- Procedure finished (Fig.I ref.6)

**WARNING! Incorrect settings can result in damage to property and injury to people and animals.**



**WARNING: Check that the force of impact measured at the points provided for by standard EN 12445 is lower than the value laid down by standard EN 12453.**







**Impact forces can be reduced by using deformable edges.**

For best results, it is advisable to run the autoset function with the motors idle (i.e. not overheated by a considerable number of consecutive operations).

# INSTALLATION MANUAL

D812865 00100\_04

**TABLE "A" - PARAMETERS MENU - (PR-RF)**

Parameter	min.	max.	Default	Personal	Definition	Description
worK. t. Mot.1	3.0	180.0	60.0		Operation time motor 1 [s]	Sets the value of motor 1 / 2 work time in seconds At the end of an autaset it is set with the actual motor work value
worK. t. Mot.2	3.0	180.0	60.0		Operation time motor 2 [s]	
PRt IRL oPEn InG	3	90	6		Partial opening M1 [s]	Time of partial opening following the activation of motor M1 PED pedestrian control
oPEn dELAY t INE	0	10	3		Motor 2 opening delay time [s]	Motor 2 opening delay time with respect to motor 1.
cLS dELAY t INE	0	25	3		Motor 1 closing delay time [s]	Motor 1 closing delay time with respect to motor 2.
SLow - down t. Mot.1	0	30	0		Slow-down time motor 1 [s]	Sets the approach slow-down time. The slow-down time is subtracted from the work time. <b>NOTE:</b> Use this function only if a limit switch is installed. <b>NOTE:</b> Do not use with hydraulic motors. (***)
SLow - down t. Mot.2	0	30	0		Slow-down time motor 2 [s]	
t cR	0	120	10		Automatic closing time [s]	Waiting time before automatic closing.
t rFLGht cLRt	1	180	40		Time-to-clear traffic light zone [s]	Time-to-clear for the zone run through by traffic controlled by the traffic light.
oUtPUt t INE	1	240	10		Activation time of the timed output [s]	Activation length of timed radio channel output in seconds
oPForcE	1	99	50		Leaf force during opening [%]	Force exerted by leaf/leaves during opening. Represents the percentage of force delivered at speed in comparison with the maximum value.  <b>WARNING: It affects impact force directly: make sure that current safety requirements are met with the set value (*).</b> <b>If necessary, install anti-crushing safety devices (**).</b> (***)
cLSForcE	1	99	50		Leaf force during closing [%]	Force exerted by leaf/leaves during closing. Represents the percentage of force delivered at speed in comparison with the maximum value.  <b>WARNING: It affects impact force directly: make sure that current safety requirements are met with the set value (*).</b> <b>If necessary, install anti-crushing safety devices (**).</b> (***)
SLowForcE	1	99	50		Forza motori in rallentamento [%]	Force exerted by leaf / and slowdown. It represents the percentage of power supplied to slow down.  <b>WARNING: It affects impact force directly: make sure that current safety requirements are met with the set value (*).</b> <b>If necessary, install anti-crushing safety devices (**).</b> (***)
brAKE	0	99	0		Braking [%]	Set the braking value from 0% (min.) to 99% (max.) according to the gate weight and the mechanical demands involved.
EMER. brAKE	0	99	60		Emergency braking [%]	Sets the value between 0% (min.) and 99% (max.) of emergency braking, that is performed by activating the safety controls present at the inputs configured as BAR safety edge.
PrEHt.	0	99	30		Preheating [%]	Set the percentage value of the current from 0 (deactivated pre-heating) to 99% which can be made to pass through the motor windings to keep them at the right temperature. <b>NOTE: the NTC temperature sensor must be connected</b> The sensor must be placed and fixed in contact with the motor to detect the outside temperature
obStSEnS.	0	99	0		Obstacle sensitivity	It allows activating obstacle detection. The function is disabled when the parameter is set to 0, setting the value between 1 and the maximum value, obstacle sensitivity can be increased (max value = max sensitivity). It works only with the limit switches.  <b>ATTENTION: This obstacle detection function does not guarantee compliance with the safety regulations in force (*). To comply with the current safety regulations, install adequate anti-crushing safety devices (**).</b>  <b>ATTENTION: The system detects the obstacle only if the leaf is stopped; no obstacles breaking the leaf without managing to stop it are detected. Detection takes place only if the leaf meeting the obstacle is moving at normal speed. The obstacle is not detected during slow-down.</b> (***)
PR InTErRncE	0	250	0		Programming number of operations for maintenance threshold [in hundreds]	Allows you to set a number of operations after which the need for maintenance will be reported on the AUX output configured as Maintenance or Flashing Light and Maintenance .

(\*) In the European Union, apply standard EN 12453 for force limitations, and standard EN 12445 for measuring method.

(\*\*) The impact forces must be limited using active coasts comply with EN12978

(\*\*\*)  **CAUTION: After a parameter change will need to run an autaset function if the "obstacle sensitivity" is active.**

# INSTALLATION MANUAL

**TABLE "B" - LOGIC MENU - (LoG ic)**

Logic	Definition	Default	Cross out setting used	Optional extras		
tCA	Automatic Closing Time	0	0	Logic not enabled		
			1	Switches automatic closing on		
FRSt cLS.	Fast closing	0	0	Logic not enabled		
			1	Closes 3 seconds after the photocells are cleared before waiting for the set TCA to elapse.		
StEP-by-StEP POUEnE	Step-by-step movement	0	0	Inputs configured as Start E, Start I, Ped operate with 4-step logic.		
			1	Inputs configured as Start E, Start I, Ped operate with 3-step logic. Pulse during closing reverses movement.		
			2	Inputs configured as Start E, Start I, Ped operate with 2-step logic. Movement reverses with each pulse.		
			<b>step-by-step mov.</b>			
			CLOSED	OPENS	OPENS	OPENS
			DURING CLOSING	OPENS	OPENS	STOPS
OPEN	CLOSES	CLOSES	CLOSES			
DURING OPENING	CLOSES	STOP + TCA	STOP + TCA			
AFTER STOP	OPENS	OPENS	OPENS			
PrE-ALArP	Pre-alarm	0	0	The flashing light comes on at the same time as the motor(s) start.		
			1	The flashing light comes on approx. 3 seconds before the motor(s) start.		
hOld-to-rUn	Deadman	0	0	Pulse operation.		
			1	Deadman mode. Input 61 is configured as OPEN UP. Input 62 is configured as CLOSE UP. Operation continues as long as the OPEN UP or CLOSE UP keys are held down. <b>WARNING: safety devices are not enabled.</b>		
			2	Emergency Deadman mode. Usually pulse operation. If the board fails the safety device tests (photocell or safety edge, Er0x) 3 times in a row, the device is switched to Deadman mode, which will stay active until the OPEN UP or CLOSE UP keys are released. Input 61 is configured as OPEN UP. Input 62 is configured as CLOSE UP. <b>WARNING: with the device set to Emergency Deadman mode, safety devices are not enabled.</b>		
IbL oPEn	Block pulses during opening	0	0	Pulse from inputs configured as Start E, Start I, Ped has effect during opening.		
			1	Pulse from inputs configured as Start E, Start I, Ped has no effect during opening.		
IbL tCA	Block pulses during TCA	0	0	Pulse from inputs configured as Start E, Start I, Ped has effect during TCA pause.		
			1	Pulse from inputs configured as Start E, Start I, Ped has no effect during TCA pause.		
IbL cLoSE	Block pulses during closing	0	0	Pulse from inputs configured as Start E, Start I, Ped has effect during closing.		
			1	Pulse from inputs configured as Start E, Start I, Ped has no effect during closing.		
rAP bLoU cOP	Hammer during opening	0	0	Logic not enabled		
			1	Before opening completely, the gate pushes for approx. 2 seconds as it closes. This allows the solenoid lock to be released more easily. <b>IMPORTANT - Do not use this function if suitable mechanical stops are not in place.</b>		
rAP bLoU cCL	Hammer during closing	0	0	Logic not enabled		
			1	Before closing completely, the gate pushes for approx. 2 seconds as it opens. This allows the solenoid lock to be released more easily. <b>IMPORTANT - Do not use this function if suitable mechanical stops are not in place.</b>		
bLoC PErS ISt	Stop maintenance	0	0	Logic not enabled		
			1	If motors stay idle in fully open or fully closed position for more than one hour, they are switched on in the direction of the stop for approx. 3 seconds. This operation is performed every hour. NB: In hydraulic motors, this function serves to compensate a possible reduction in the volume of oil due to a drop in temperature during extended pauses, such as during the night, or due to internal leakage. <b>IMPORTANT - Do not use this function if suitable mechanical stops are not in place.</b>		
PrESS Sbc	Closing limit switch pressure	0	0	Movement is stopped only when the closing limit switch trips: in this case, the tripping of the closing limit switch must be adjusted accurately ( <b>Fig.G Ref.B</b> ).		
			1	Use when there is a mechanical stop in closed position. This function allows leaves to press against the mechanical stop without the Amperestop sensor interpreting this as an obstacle. Thus the rod continues its stroke for a few seconds after meeting the closing limit switch or as far as the mechanical stop. In this way, the leaves come to rest perfectly against the stop by allowing the closing limit switches to trip slightly earlier ( <b>Fig.G Ref.A</b> ).		
1 Mot.on	1 motor active	0	0	Both motors active (2 leaves).		
			1	Only motor 1 active (1 leaf).		
oPEn In othEr d IrEcT.	Open in other direction	0	0	Standard operating mode ( <b>See Fig.G Ref. C</b> ).		
			1	Opens in other direction to standard operating mode ( <b>See Fig. G Ref.D</b> )		
SAFE 1	Configuration of safety input SAFE 1.	0	72	Input configured as Phot (photocell).		
			1	Input configured as Phot test (tested photocell).		
			2	Input configured as Phot op (photocell active during opening only).		



# INSTALLATION MANUAL

D812865 00100\_04

Logic	Definition	Default	Cross out setting used	Optional extras
SAFE 2	Configuration of safety input SAFE 2. 74	6	3	Input configured as Phot op test (tested photocell active during opening only).
			4	Input configured as Phot cl (photocell active during closing only).
SAFE 3	Configuration of safety input SAFE 3. 77	2	5	Input configured as Phot cl test (tested photocell active during closing only).
			6	Input configured as Bar, safety edge.
SAFE 4	Configuration of safety input SAFE 4. 79	4	7	Input configured as Bar, tested safety edge.
			8	Input configured as Bar 8k2 ( <b>Inactive on SAFE 3,4,5,6</b> ).
SAFE 5	Configuration of safety input SAFE 4. 79	0	9	Input configured as Bar OP, safety edge with inversion active only while opening. If while closing, the movement stops.
			10	Input configured as Bar OP TEST, safety edge tested with inversion active only while opening. If while closing, the movement stops.
SAFE 6	Configuration of safety input SAFE 6. 84	6	11	Input configured as Bar OP 8k2, safety edge with inversion active only while opening. If while closing, the movement stops. ( <b>Inactive on SAFE 3,4,5,6</b> ).
			12	Input configured as Bar CL, safety edge with inversion active only while closing. If while opening, the movement stops.
			13	Input configured as Bar CL TEST, safety edge tested with inversion active only while closing. If while opening, the movement stops.
			14	Input configured as Bar CL 8k2, safety edge with inversion active only while closing. If while opening, the movement stops. ( <b>Inactive on SAFE 3,4,5,6</b> ).
ic 1	Configuration of command input IC 1. 61	0	0	Input configured as Start E.
			1	Input configured as Start I.
ic 2	Configuration of command input IC 2. 62	4	2	Input configured as Open.
			3	Input configured as Close.
ic 3	Configuration of command input IC 3. 64	2	4	Input configured as Ped.
			5	Input configured as Timer.
ic 4	Configuration of command input IC 4. 65	3	6	Input configured as Timer Pedestrian.
ich	Configuration of the 1st radio channel command	0	0	Radio control configured as START E.
			1	Radio control configured as Start I.
			2	Radio control configured as Open.
2ch	Configuration of the 2nd radio channel command	9	3	Radio control configured as Close
			4	Radio control configured as Ped
			5	Radio control configured as STOP
			6	Radio control configured as AUX0 **
3 ch	Configuration of the 3rd radio channel command	2	7	Radio control configured as AUX1 **
			8	Radio control configured as AUX2 **
			9	Radio control configured as AUX3 **
4 ch	Configuration of the 4th radio channel command	5	10	Radio control configured as EXPO1 **
			11	Radio control configured as EXPO2 **
AUX 0	Configuration of AUX 0 output. 20-21	6	0	Output configured as monostable Radio Channel.
			1	Output configured as SCA (gate open light).
			2	Output configured as Courtesy Light command.
AUX 1	Configuration of AUX 1 output. 22-23	3	3	Output configured as Zone Light command.
			4	Output configured as Stair Light
			5	Output configured as Alarm
AUX 2	Configuration of AUX 2 output. 24-25	1	6	Output configured as Flashing light
			7	Output configured as Latch
			8	Output configured as Magnetic lock
AUX 3	Configuration of AUX 3 output. 26-37	0	9	Output configured as Maintenance
			10	Output configured as Flashing Light and Maintenance.
			11	Not used
			12	Not used
			13	Output configured as Gate Status
			14	Output configured as Bistable Radio Channel
LocH	Type of lock. 28-29	0	0	Output configured as 12V== solenoid latch.
			1	Output configured as 12V== magnetic lock.
F IHEd code	Fixed code	0	0	Receiver is configured for operation in rolling-code mode. Fixed-Code Clones are not accepted.
			1	Receiver is configured for operation in fixed-code mode. Fixed-Code Clones are accepted.

# INSTALLATION MANUAL

Logic	Definition	Default	Cross out setting used	Optional extras
<b>Protect ion LEVEL</b>	<b>Setting the protection level</b>	0	0	<p>A - The password is not required to access the programming menus</p> <p>B - Enables wireless memorizing of transmitters.</p> <p>Operations in this mode are carried out near the control panel and do not require access:</p> <ul style="list-style-type: none"> <li>- Press in sequence the hidden key and normal key (T1-T2-T3-T4) of a transmitter that has already been memorized in standard mode via the radio menu.</li> <li>- Press within 10 sec. the hidden key and normal key (T1-T2-T3-T4) of a transmitter to be memorized.</li> </ul> <p>The receiver exits programming mode after 10 sec.; you can use this time to enter other new transmitters by repeating the previous step.</p> <p>C - Enables wireless automatic addition of clones.</p> <p>Enables clones generated with the universal programmer and programmed Replays to be added to the receiver's memory.</p> <p>D - Enables wireless automatic addition of replays.</p> <p>Enables programmed Replays to be added to the receiver's memory.</p> <p>E - The board's parameters can be edited via the U-link network</p>
			1	<p>A - You are prompted to enter the password to access the programming menus</p> <p>The default password is 1234.</p> <p>No change in behaviour of functions B - C - D - E from 0 logic setting</p>
			2	<p>A - You are prompted to enter the password to access the programming menus</p> <p>The default password is 1234.</p> <p>B - Wireless memorizing of transmitters is disabled.</p> <p>C - Wireless automatic addition of clones is disabled. No change in behaviour of functions D - E from 0 logic setting</p>
			3	<p>A - You are prompted to enter the password to access the programming menus</p> <p>The default password is 1234.</p> <p>B - Wireless memorizing of transmitters is disabled.</p> <p>D - Wireless automatic addition of Replays is disabled.</p> <p>No change in behaviour of functions C - E from 0 logic setting</p>
			4	<p>A - You are prompted to enter the password to access the programming menus</p> <p>The default password is 1234.</p> <p>B - Wireless memorizing of transmitters is disabled.</p> <p>C - Wireless automatic addition of clones is disabled.</p> <p>D - Wireless automatic addition of Replays is disabled.</p> <p>E - The option of editing the board's parameters via the U-link network is disabled.</p> <p>Transmitters are memorized only using the relevant Radio menu.</p> <p><b>IMPORTANT:</b> This high level of security stops unwanted clones from gaining access and also stops radio interference, if any.</p>
<b>SERIAL Mode</b>	<b>Serial mode</b> <small>(Identifies how board is configured in a BFT network connection).</small>	0	0	Standard SLAVE: board receives and communicates commands/diagnostics/etc.
			1	Standard MASTER: board sends activation commands (START, OPEN, CLOSE, PED, STOP) to other boards.
<b>Address</b>	<b>Address</b>	0	[ ____ ]	Identifies board address from 0 to 119 in a local BFT network connection. <small>(see U-LINK OPTIONAL MODULES section)</small>
<b>chrono</b>	<b>Time bands</b>	0	0	Logic not enabled
			1	Activates the time bands configured as timer
			2	Activates the time bands configured as pedestrian timer
<b>EXP 11</b>	<b>Configuration of EXP11 input on input-output expansion board.</b> 1-2	1	0	Input configured as Start E command.
			1	Input configured as Start I command.
			2	Input configured as Open command.
			3	Input configured as Close command.
			4	Input configured as Ped command.
			5	Input configured as Timer command.
			6	Input configured as Timer Pedestrian command.
			7	Input configured as Phot (photocell) safety.
			8	Input configured as Phot op safety (photocell active during opening only).
			9	Input configured as Phot cl safety (photocell active during closing only).
			10	Input configured as Bar safety (safety edge).
			11	Input configured as safety Bar OP, safety edge with inversion active only while opening, if while closing the movement stops.
			12	Input configured as safety Bar CL, safety edge with inversion active only while closing, if while opening the movement stops.
			13	Input configured as Phot test safety, tested photocell. Input 3 (EXPI2) on input/output expansion board is switched automatically to safety device test input, EXPFAULT1.
			14	Input configured as Phot op test safety, tested photocell active only while opening. Input 3 (EXPI2) on input/output expansion board is switched automatically to safety device test input, EXPFAULT1
			15	Input configured as Phot cl test safety, tested photocell active only while closing. Input 3 (EXPI2) on input/output expansion board is switched automatically to safety device test input, EXPFAULT1
			16	Input configured as Bar safety, tested safety edge. Input 3 (EXPI2) on input/output expansion board is switched automatically to safety device test input, EXPFAULT1.
			17	Input configured as safety Bar OP test, safety edge with inversion active only while opening, if while closing the movement stops. Input 3 (EXPI2) on input/output expansion board is switched automatically to safety device test input, EXPFAULT1.
			18	Input configured as safety Bar CL test, safety edge with inversion active only while closing, if while opening the movement stops. Input 3 (EXPI2) on input/output expansion board is switched automatically to safety device test input, EXPFAULT1.

# INSTALLATION MANUAL

D812865 00100\_04

Logic	Definition	Default	Cross out setting used	Optional extras
<i>EHP12</i>	<b>Configuration of EXPI2 input on input-output expansion board 1-3</b>	0	0	Input configured as Start E command.
			1	Input configured as Start I command.
			2	Input configured as Open command.
			3	Input configured as Close command.
			4	Input configured as Ped command.
			5	Input configured as Timer command.
			6	Input configured as Timer Pedestrian command.
			7	Input configured as Phot (photocell) safety.
			8	Input configured as Phot op safety (photocell active during opening only).
			9	Input configured as Phot cl safety (photocell active during closing only).
			10	Input configured as Bar safety (safety edge).
			11	Input configured as safety Bar OP, safety edge with inversion active only while opening, if while closing the movement stops.
12	Input configured as safety Bar CL, safety edge with inversion active only while closing, if while opening the movement stops.			
<i>EHP01</i>	<b>Configuration of EXPO2 output on input-output expansion board 4-5</b>	11	0	Output configured as monostable Radio Channel.
			1	Output configured as SCA (gate open light).
			2	Output configured as Courtesy Light command.
			3	Output configured as Zone Light command.
			4	Output configured as Stair Light.
<i>EHP02</i>	<b>Configuration of EXPO2 output on input-output expansion board 6-7</b>	11	5	Output configured as Alarm.
			6	Output configured as Flashing light.
			7	Output configured as Latch.
			8	Output configured as Magnetic lock.
			9	Output configured as Maintenance.
			10	Output configured as Flashing Light and Maintenance.
			11	Output configured as Traffic Light control with TLB board.
			12	Not used
			13	Output configured as Gate Status
			14	Output configured as Bistable Radio Channel
15	Output configured as timed Radio Channel			
<i>TRAFFIC LIGHT PREFLASHING</i>	<b>Traffic light pre-flashing</b>	0	0	Pre-flashing switched off.
			1	Red lights flash, for 3 seconds, at start of operation.
<i>TRAFFIC LIGHT RED ALWAYS ON</i>	<b>Steadily lit red light</b>	0	0	Red lights off when gate closed.
			1	Red lights on when gate closed.

\* Only active on FW > 1.12

Radio channel control configuration
CH logic= 0 - Control configured as Start E. Operation according to 5LEP-bY-5LEP logic. External start for traffic light control.
CH logic= 1 - Control configured as Start I. Operation according to 5LEP-bY-5LEP logic. Internal start for traffic light control.
CH logic= 2 - Control configured as Open. The command causes the leaves to open.
CH logic= 3 - Control configured as Closed. The command causes the leaves to close.
CH logic= 4 - Control configured as Ped. The command causes the leaf to open to the pedestrian (partial) opening position. Operation according to 5LEP-bY-5LEP logic
Logica CH= 5- Control configured as STOP. The command performs a STOP
CH logic= 6 - Control configured as AUX0. (**) The control activates the AUX0 output
CH logic= 7 - Control configured as AUX1. (**) The control activates the AUX1 output
CH logic= 8 - Control configured as AUX2. (**) The control activates the AUX2 output
CH logic= 9 - Control configured as AUX3. (**) The control activates the AUX3 output
CH logic= 10 - Control configured as EXPO1. (**) The control activates the EXPO1 output
CH logic= 11 - Control configured as EXPO2. (**) The control activates the EXPO2 output

(\*\*) Active only if the output is configured as Monostable Radio Channel, Courtesy Light, Zone Light, Stair Light, Bistable Radio Channel or Timed Radio Channel.

TABLE "C" – RADIO MENU (r-Rd Ia)

Logic	Description
<i>Add 1ch</i>	<b>Add 1ch Key</b> associates the desired key with the 1nd radio channel command.
<i>Add 2ch</i>	<b>Add 2ch Key</b> associates the desired key with the 2nd radio channel command.
<i>Add 3ch</i>	<b>Add 3ch Key</b> associates the desired key with the 3nd radio channel command.
<i>Add 4ch</i>	<b>Add 4ch Key</b> associates the desired key with the 4nd radio channel command.
<i>ErASE 64</i>	<b>Erase List</b>  <b>WARNING!</b> Erases all memorized transmitters from the receiver's memory.
<i>ErASE 1</i>	<b>Eliminates individual radio control</b> Removes a radio control (if clone or replay is disabled) To select the radio control to be deleted, enter the position or press a button on the radio control to be deleted (the position is displayed)
<i>cod rH</i>	<b>Read receiver code</b> Displays receiver code required for cloning transmitters.

**Bft Spa**

Via Lago di Vico, 44 ITALY  
36015 Schio (VI)  
T +39 0445 69 65 11  
F +39 0445 69 65 22  
→www.bft-automation.com

**SPAIN**

**BFT GROUP ITALIBERICA DE AUTOMATISMOS S.L.**  
08401 Granollers - (Barcelona)  
www.bftautomatismos.com

**FRANCE**

**AUTOMATISMES BFT FRANCE**  
69800 Saint Priest  
www.bft-france.com

**GERMANY**

**BFT TORANTRIEBSSYSTEME GmbH**  
90522 Oberasbach  
www.bft-torantriebe.de

**UNITED KINGDOM**

**BFT AUTOMATION UK LTD**  
Heaton Mersey, Stockport SK4 3GL  
www.bft.co.uk

**IRELAND**

**BFT AUTOMATION LTD**  
Dublin 12

**BENELUX**

**BFT BENELUX SA**  
1400 Nivelles  
www.bftbenelux.be

**POLAND**

**BFT POLSKA SP.ZO.O.**  
Marecka 49, 05-220 Zielonka  
www.bft.pl

**CROATIA**

**BFT ADRIA D.O.O.**  
51218 Drazice (Rijeka)  
www.bft.hr

**PORTUGAL**

**BFT SA-COMERCIO DE AUTOMATISMOS E MATERIAL DE SEGURANCIA**  
3026-901 Coimbra  
www.bftportugal.com

**CZECH REPUBLIC**

**BFT CZ S.R.O.**  
Praha  
www.bft.it

**TURKEY**

**BFT OTOMATIK KAPI SISTEMELERI SANAY VE**  
Istanbul  
www.bftotomasyon.com.tr

**RUSSIA**

**BFT RUSSIA**  
111020 Moscow  
www.bftrus.ru

**AUSTRALIA**

**BFT AUTOMATION AUSTRALIA PTY LTD**  
Wetherill Park (Sydney)  
www.bftaustralia.com.au

**U.S.A.**

**BFT USA**  
Boca Raton  
www.bft-usa.com

**CHINA**

**BFT CHINA**  
Shanghai 200072  
www.bft-china.cn

**UAE**

**BFT Middle East FZCO**  
Dubai