

# DIGITAL GSM

4000 Series Vandal Resistant Digital GSM Audio Intercom  
with Proximity

**4812 / VR4812**

**4812R / VR4812R**

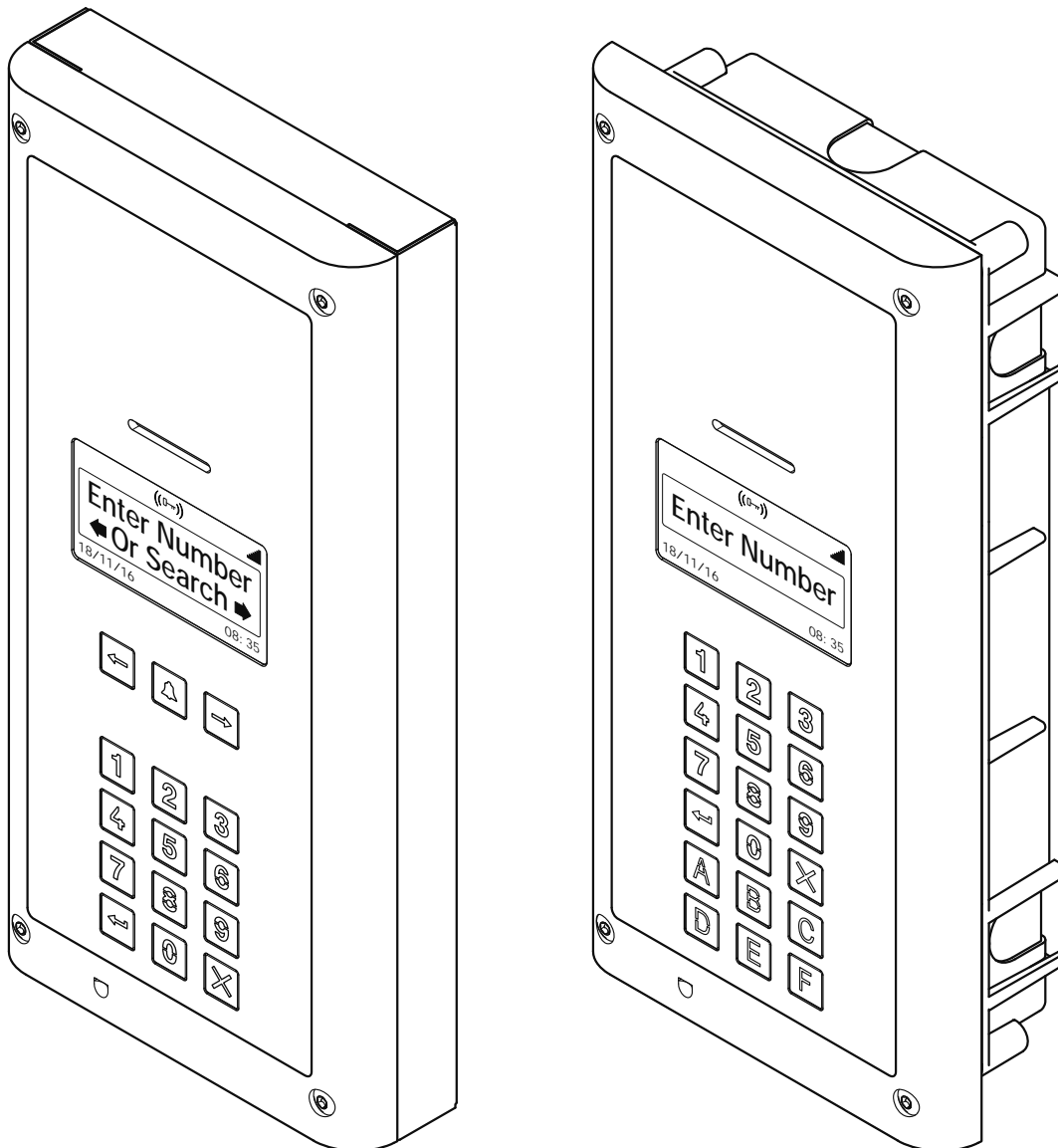

## Technical Manual



# Declaration of Conformity

## EU RoHS DECLARATION OF CONFORMITY

### 2G version

Telit Communications certifies that the GL865-QUAD V3 (Quad Band GSM850/EGSM900/DCS1800/PCS1900 GPRS Wireless Module) is in conformity with Directive 2011/65/EU of the European Parliament and the Council of 8th June 2011 on the restriction of the use of certain hazardous substances in electrical and electronic equipment. The conformity with the applicable requirements of the Directive 2011/65/EU has been demonstrated against the following harmonized standard: EN 50581:2012 Technical Documentation for the assessment of electrical and electronic products with respect to the restriction of hazardous substances.

### 3G version

Telit Communications certifies that the UL865-EUR (Dual Band 2G EGSM900/DCS1800 and Dual Band 3G FDD I/FDD VIII Wireless Module) is in compliance with the essential requirements and other relevant provisions of European Directive 1999/5/EC (R&TTE). The conformity with the essential requirements of the Directive 1999/5/EC has been demonstrated against the following harmonized standards:

Article of Directive 1999/5/EC	Harmonized Standard Reference
Health & Safety (R&TTE art. 3.1a)	EN 60950-1:2006 + A11:2009 + A1:2010 + A12:2011 + AC2011 EN 62311:2008
EMC (R&TTE art. 3.1b)	EN 301 489-1 V1.9.2 EN 301 489-7 V1.3.1 EN 301 489-24 V1.5.1
RF Spectrum use (R&TTE art. 3.2)	EN 301 511 V9.02 EN 301 908-1 V5.2.1 EN 301 908-2 V5.2.1



### WARNING!

To comply with FCC RF exposure requirements, a separation distance of 20cm (7.87") or more must be maintained between the antenna of this product and all persons.

Separate FCC approval for this product is not required as it will be classed as a fixed installation.

**THIS PRODUCT IS NOT DESIGNED TO BE USED AS AN EMERGENCY CALL POINT.**

### MANUFACTURER



### VIDEX ELECTRONICS S.P.A.

Via del Lavoro, 1 - 63846 Monte Gilberto (FM) Italy  
 Tel: (+39) 0734-631699 - Fax: (+39) 0734-632475  
 www.videx.it - info@videx.it



### CUSTOMER SUPPORT

All Countries:  
**VIDEX ELECTRONICS S.P.A.**  
 www.videx.it - technical@videx.it  
 Tel: +39 0734-631699 - Fax: +39 0734-632475

UK Customers:  
**VIDEX SECURITY LTD.**  
 www.videxuk.com - tech@videxuk.com  
 Tech Line: 0191 224 3174 - Fax: 0191 224 1559



The product is CE marked demonstrating its conformity and is for distribution within all member states of the EU with no restrictions. This product follows the provisions of the European Directives 2014/30/EU (EMC); 2014/35/EU (LVD); 2011/65/EU (RoHS): CE marking 93/68/EEC.

# Contents

<b>Introduction .....</b>	<b>4</b>
<b>System Components and Available Versions .....</b>	<b>6</b>
<b>Art. 4812/4812R Technical Information.....</b>	<b>8</b>
<b>Wiring Diagrams .....</b>	<b>10</b>
<b>Auxiliary Input &amp; Output .....</b>	<b>12</b>
<b>USB &amp; RS485 Connection .....</b>	<b>14</b>
<b>RS485 Bus Connection to an Art. 4850R .....</b>	<b>16</b>
<b>General Directions for Installation.....</b>	<b>17</b>
<b>Fitting the SIM &amp; Connecting Power .....</b>	<b>20</b>
<b>Reset Procedure.....</b>	<b>21</b>
<b>4000 Series Back Box Installation .....</b>	<b>22</b>
<b>Programming via Alpha-Numeric Keypad.....</b>	<b>26</b>
<b>Programming Flowcharts .....</b>	<b>27</b>
<b>Programming Screens.....</b>	<b>36</b>
<b>Programming via Text Message .....</b>	<b>45</b>
<b>The GSM Mobile App.....</b>	<b>62</b>
<b>System Operation .....</b>	<b>63</b>
<b>User Commands.....</b>	<b>66</b>
<b>Additional User Information.....</b>	<b>67</b>
<b>User Management .....</b>	<b>69</b>
<b>Troubleshooting .....</b>	<b>70</b>
<b>General Information.....</b>	<b>72</b>
<b>Notes.....</b>	<b>73</b>

# Introduction

## MANUAL INTRODUCTION

The information in this manual is intended as an installation and commissioning guide for the Digital GSM audio intercom system. This manual should be read carefully before the installation commences. Any damage caused to the equipment due to faulty installation where the information in this manual has not been followed is not the responsibility of Videx Security Ltd.

**It is recommended that the Digital GSM audio intercom is installed by a competent electrician, security or communications engineer.**

For UK customers Videx run free training courses for engineers who are unfamiliar or who have not installed this system before. Technical help is also available for UK customers on tel: 0191 224 3174 during office hours (8:30am - 5:00pm MON to FRI) or via e-mail: [tech@videxuk.com](mailto:tech@videxuk.com) and for all overseas customers on tel: +39 0734 631669 or via e-mail: [technical@videx.it](mailto:technical@videx.it).

A copy of this Technical Manual can also be downloaded from the Videx websites: For UK customers [www.videxuk.com](http://www.videxuk.com) and for overseas customers [www.videx.it](http://www.videx.it).

## SYSTEM INTRODUCTION

The vandal resistant digital GSM is designed to work on the same technology as mobile phones. It enables a call to be made from an entry point (door, gate etc), to any telephone number (mobile or land line). Up to 500 users can be programmed into the door panel, each able to call up to four telephone numbers (if the primary number is busy or not answered, the call can be diverted through to up to three different divert numbers). The standard digital GSM intercom works on a 2G network. A 3G variant is also available (suffix /3G to the part number e.g. **Art.4812/3G**, **Art.VR4812/3G** etc.).

Key features of the system include:

- Vandal resistant brushed stainless steel (2mm thick) front panel.
- Blue back-lit alpha-numeric keypad (for system operation and programming).
- Blue back-lit 128x64 pixel graphical LCD display.
- Speech annunciation.
- Micro-USB connection (for ease of programming using the GSMSK PC software).
- A dry contact relay (CO, NO and NC).
- A switched 0V auxiliary input (AI) and an open collector auxiliary output (AO).
- Switched 0V push to exit input (push-to-make) and trade input.
- RS485 connection for ease of programming using the GSMSK PC software or to allow for a connection of a parallel proximity reader, the **Art.4850R**, further information can be found in the installation instructions: **4850R\_66250407\_EN\_V1-1** (or later).
- Proximity fobs/cards for up to 2000 users.
- Dial to Open facility (this feature enables up to 2000 stored numbers to dial the digital GSM, the intercom panel will not answer these calls, but will activate the door/gate relay without being charged for the call).
- 500 programmable users (each with 4 numbers, 1 primary and 3 diverts).
- 500 programmable door access codes (1 code per user).
- 10 timebands (9 of which are programmable).
- Up to 10 Free Access programmable timebands.
- Event logging system (which can record up to 8000 events).

**IMPORTANT NOTE:** Although all the features and general installation instructions mentioned in this technical manual make reference to the **Art.4812** and **Art.4812R** digital GSM intercoms the same features and instructions can also be applied when installing the **VR4812** and **VR4812R** digital GSM intercoms.

Programming of telephone numbers and the additional features, including programming key fobs/cards for proximity access, can be carried out via text messaging or PC using the GSMSK PC software, refer to the manual **GSMSK\_66251720\_EN\_V2-0** (or later). Limited programming features can also be programmed via the GSM mobile app, the **Videx SMS Wizard** (refer to notes **the GSM mobile app** on page 62).

## SIM CARD SELECTION

**A SIM card is required for this product but not supplied by Videx.** The GSM intercom can only accept a standard size SIM card (refer to the following SIM card size chart), both a micro-SIM and nano-SIM are not suitable. It is recommended to choose the SIM card which has the best coverage for the area in which the intercom panel will be installed. Both contract and 'Pay as you go' SIM cards can be used, however if using a 'Pay as you go' we would recommend setting up an automatic top up to avoid running short on credit and losing the use of the intercom panel. Alternatively if you already have a contract mobile phone it should be possible to get a second SIM card and telephone number on the existing account. For more information contact the SIM card provider or visit their website.

## Introduction

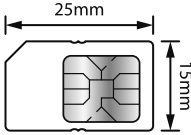
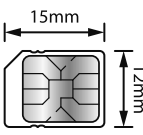
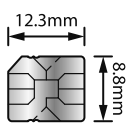
Standard SIM		Micro-SIM		Nano-SIM	
<input checked="" type="checkbox"/>		<input type="checkbox"/>		<input type="checkbox"/>	

### NETWORK PROVIDER SELECTION

It is imperative that for the reliable operation of the system that the best network provider for the area is selected. Problems such as network disconnection can occur if the provider has signal or interference problems for that area. We would recommend using a GSM signal strength meter to survey the intended antenna location. Contact Videx for more information on where to purchase a tester.

For UK customers, as an initial check we also recommend visiting the ofcom website [www.ofcom.org.uk](http://www.ofcom.org.uk) and follow the onsite links to their online mobile coverage tool (*ofcom broadband and mobile coverage checker*). This tool will advise on the best coverage for the main network providers and other general queries that you may have about the service provider. For all overseas customers we suggest consulting the website of the network provider that will be used to check the coverage in your area.

The antenna should always be mounted vertically at the highest point possible. Metal structures and sources of interference such as power cables, control panels etc. can affect signals and so the antenna should be mounted away from these.

When registering a new SIM you may be asked for the IMEI number. This is the unique serial number of the GSM intercom. This number is located internally on the main hardware chip inside the GSM module. To obtain the IMEI number from the GSM module refer to the programming notes **obtain the GSM's IMEI number** on page 61.

### PRECAUTIONARY ADVICE

- When mounting the GSM antenna, choose a location which is away from human interaction and away from the intercom panel. Route the GSM antenna cable from the intercom panel so that it is separate from the power supply cables and microphone wire.
- Always ensure the power is switched OFF to the intercom panel before inserting or removing the SIM card.
- New SIM cards will need registering with the network service provider before they can be used. Full details of how this is done can normally be found in the SIM card pack. It will normally require that the SIM card is inserted into a mobile phone, a number dialled and instructions followed. While the SIM is in the mobile phone it would be a good time to disable any PIN codes, call diverts, ring back and disable features such as voicemail and text alerts. Details of how to do this can be found on the SIM card provider's web site or by calling their customer services. Recommended SIM card providers are: Vodafone, T-Mobile, O2 or Orange/EE. **The 3 network can only be used on our 3G devices (Art.4812/3G, Art.VR4812/3G etc.), also see Fig.9 on page 8.**
- To be able to receive text messages from the intercom panel, the SIM card will require an SMS service centre number. This is normally preinstalled on new SIM cards but if you are having trouble receiving SMS messages you will need to confirm this by inserting the SIM card into a mobile phone and using the phones menu options to check it. If a number is not programmed then it should be programmed while in the phone (the number can be obtained from the network service provider).
- Voicemail and text alerts must be switched OFF on the SIM card when using the dial in to release the door/gate feature. For Vodafone and O2 this can be done while the SIM card is in the intercom panel. For Orange/EE, T-Mobile and other providers the SIM card must be removed from the intercom panel, inserted into a mobile phone and the mobile phone menu instructions followed. This procedure may vary from provider to provider of different countries, we suggest contacting your provider for information.
- When storing the intercom panel's telephone number in your own mobile phone avoid using an obvious name such as 'Front Door', or 'My Gate' as this would make it easy to decipher if your phone was lost or stolen.
- The PIN request feature must be disabled on the SIM card before using it in the Intercom panel. It is likely on a new SIM card that it will not be enabled but if it is, it will prevent the system from working at all.
- This product may not be suitable for installation in hospitals, health care facilities or in the presence of flammable gases or liquids. Seek advice and authorisation before installing this product in these locations. **This product is not designed to be used as an emergency call point.**

*Network provider and services configuration codes mentioned in this manual are specific for the UK. For overseas customers please contact the network provider of your country for the corresponding codes, however Videx offers **no guarantee** that any additional codes will work.*

### IMPORTANT NOTE ABOUT THE SIM

When using a pay monthly SIM card you can ask the service provider to put a spend limit (credit limit) on the account (Vodafone call this service 'spend checker'). This is to safeguard against possible problems which could result in a large phone bill at the end of the month. Most network providers offer this service. You will need to either ring or e-mail them to set this up. Automatic top ups should also have a monthly limit. We would suggest a limit of £50.00 which should be more than enough. **This service is not provided by Videx.**

# System Components and Available Versions

## DESCRIPTION

The 4000 series vandal resistant (front plate in brushed stainless steel with 2mm thickness) digital GSM is designed to work on the same technology as mobile phones. The panel is compatible with the vandal resistant 4000 series modular range and is the size of two 4000 series modules. It enables a call to be made from an entry point (door, gate etc), to any telephone number (mobile or land line). Up to 500 users can be programmed into the door panel, each able to call up to four telephone numbers (if the primary number is busy or not answered, the call can be diverted through to up to three different divert numbers).





Additionally, each user can have a unique access code up to 6 digits, an apartment number up to 6 digits, their numbers added to the 'DTO' dial to open list (to allow them to dial into the panel and release the door/gate), a timeband facility to restrict when an apartment can receive calls (up to 10 timebands are available 9 of which can be programmed). On the scroll panel version a user name option is available with up to 16 characters.

Also, integrated into the panel is a proximity reader enabling up to 2000 user fobs/cards to be stored and used individually or in combination with the access code. In addition the panel includes a 128x64 pixel graphical LCD display with blue back light that provides both text and graphical messages guiding a user through the panel programming and operation. The LCD graphical display can also be used to display a company logo or name which can switch between the panel's standard (or customised) welcome message and the logo.

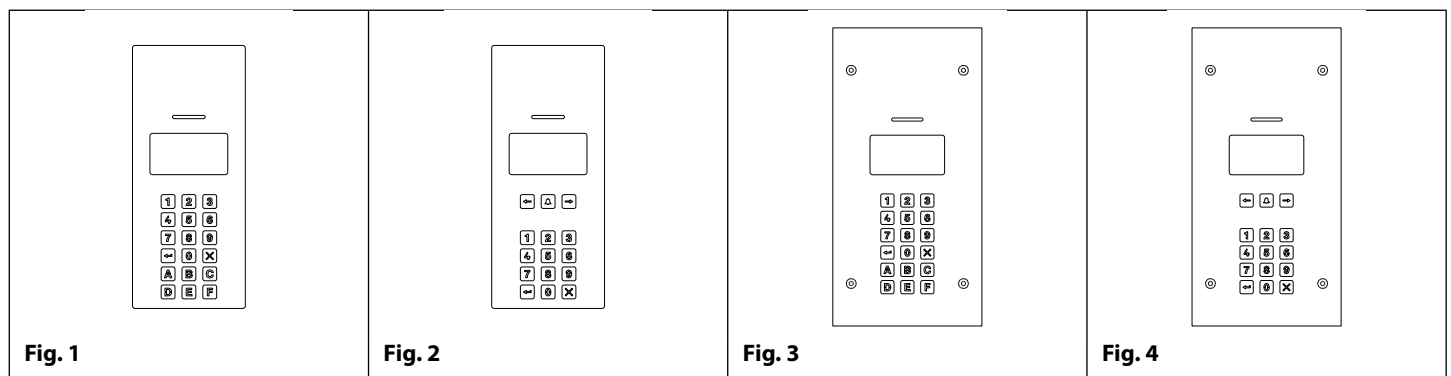
## AVAILABLE VERSIONS

Two panels are available in the vandal resistant 4000 series range, the Art.4812 (**Fig.1**) and the Art.4812R (**Fig.2**), and two panels are available in the vandal resistant digital series range, the Art.VR4812 (**Fig.3**) and the Art.VR4812R (**Fig.4**), each with an integrated programmable keypad.



The Art.4812 and Art.VR4812 has 18 back lit buttons, 6 of which are alpha buttons (A - F), 10 of which are numeric buttons (0 - 9), plus an "ENTER"  and a "CLEAR"  button. The Art.4812R and Art.VR4812R has 15 back lit buttons, 10 of which are numeric buttons (0 - 9), plus an "ENTER" and "CLEAR" button with a "CALL"  and two "SEARCH" buttons .

To compliment the visual messages provided by the display, the panel has a voice annunciation facility to supply audio messages concerning the system operation.

The onboard programming menu and setup menu are protected by two access codes with different login levels:

**The master code:** this code grants full access to all the programming functions (default '1111'):

1. **Apartment menu** - allows the programming of the apartment details, e.g. apartment name/number, telephone no's etc.
2. **Proximity menu** - allows the programming of proximity fobs/cards.
3. **General settings menu** - allows the general setup of the digital GSM, e.g. panel's volume controls, enable proximity etc.
4. **Code settings menu** - allows the programming of the master code, admin code and trade code.
5. **Time settings menu** - allows the setup and programming of the digital GSM's time settings, e.g. call time, divert time, relay time and timebands etc.

**The admin code:** this code is limited to only specific programming functions (default '0000'):

1. **Apartment menu** - allows the programming of the apartment details, e.g. apartment name/numbers, telephone no's etc.
2. **Proximity menu** - allows the programming of proximity fobs/cards.

**IMPORTANT NOTE:** The standard digital GSM intercom works on a 2G network. A 3G variant is also available (suffix /3G to the part number e.g. Art.4812/3G, Art.VR4812/3G etc.).

Programming of the telephone numbers and the additional features, including programming key fobs for the integrated proximity access, can be carried out either using the alpha-numeric keypad on the front of the panel via graphical menus, text messaging (refer to pages 45 to 61) or by using the GSM SK PC software, refer to the manual **GSM SK\_66251720\_EN\_V2-0** (or later).

Apart from the requirement of a SIM card additional parts will be required for the successful installation of the digital GSM. The following components will also be required:

## System Components and Available Versions

### 4000 SERIES BACK BOXES AND MOUNTING FRAMES

Both the Art.4812 and Art.4812R are designed to fit into a 2 module 4000 series front frame with surface or flush back box. Front support frames are available in a gun metal grey finish, chrome finish (suffix \C to the code) or gold finish (suffix \G to the code). The 4000 series mounting frames and back boxes are shown in **Fig.5** (surface) and **Fig.6** (flush) and their dimensions shown in the following table including the part numbers and dimensions for optional surface and flush 4000 series rainshields.

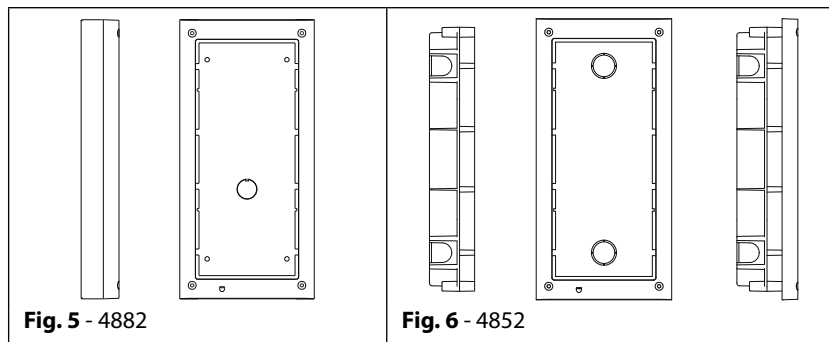

Surface Back Box Dimensions (inc. optional surface rainshield)			Flush Back Box Dimensions (inc. optional flush rainshield)		
Part No.	Module Size	(W x H x D) mm	Part No.	Module Size	(W x H x D) mm
Art.4882	2	back box: 135 x 280.2 x 43	Art.4852	2	front frame: 135 x 280.2 x 15.7 back box: 120 x 263.2 x 46
Art.4892		rainshield: 140 x 283 x 62	Art.4872		rainshield: 140 x 283 x 35

### 12VDC 2A POWER SUPPLY (HDR-15-12)

The digital GSM module is designed to work with power supplies in the range of 12Vdc and should be capable of supplying a constant current of no less than 1A. The slim line HDR-15-12, 12Vdc 1.25A power supply can be used (see **Fig.7**).

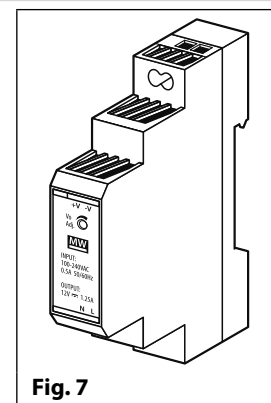

### ART. 432 GSM ANTENNA

The digital GSM also requires an antenna to function, the Art.432 GSM antenna connects to the SMA female bulkhead connection on the rear of the digital GSM module. A GSM antenna with an SMA male connector should be used (refer to **Fig.8**).

#### Antenna Parts:

1. GSM antenna with magnetic base.
2. Self-threading screw ( $\varnothing 3.5\text{mm} \times 9.5\text{mm}$ ).
3. Aluminium L bracket for mounting.
4. SMA male connector (cable length 2.5m).
5. Expansion type wall plugs ( $\varnothing 6\text{mm}$ ).
6. Self-threading screw ( $\varnothing 4\text{mm} \times 30\text{mm}$ ).

**IMPORTANT NOTE:** An antenna must always be fitted for the digital GSM module to work. Always route the GSM antenna cable away from the microphone wires and the power supply wires to avoid interference on the speech channels.

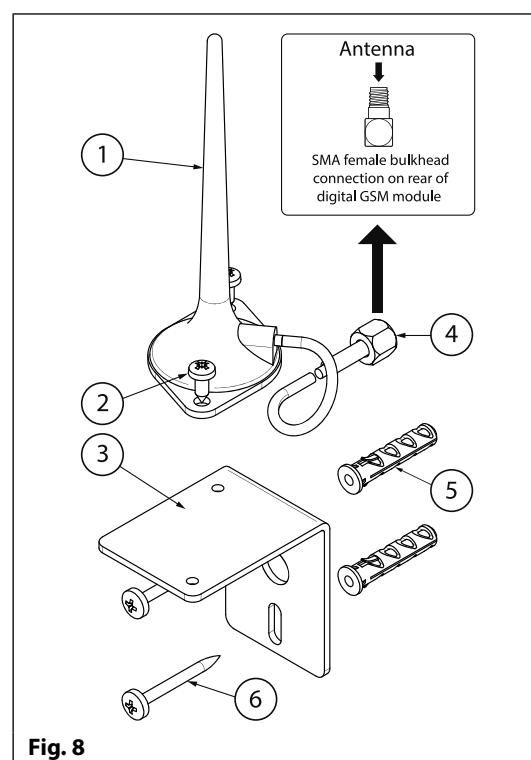

# Art. 4812/4812R Technical Information

## ART. 4812/4812R DIGITAL GSM PANEL

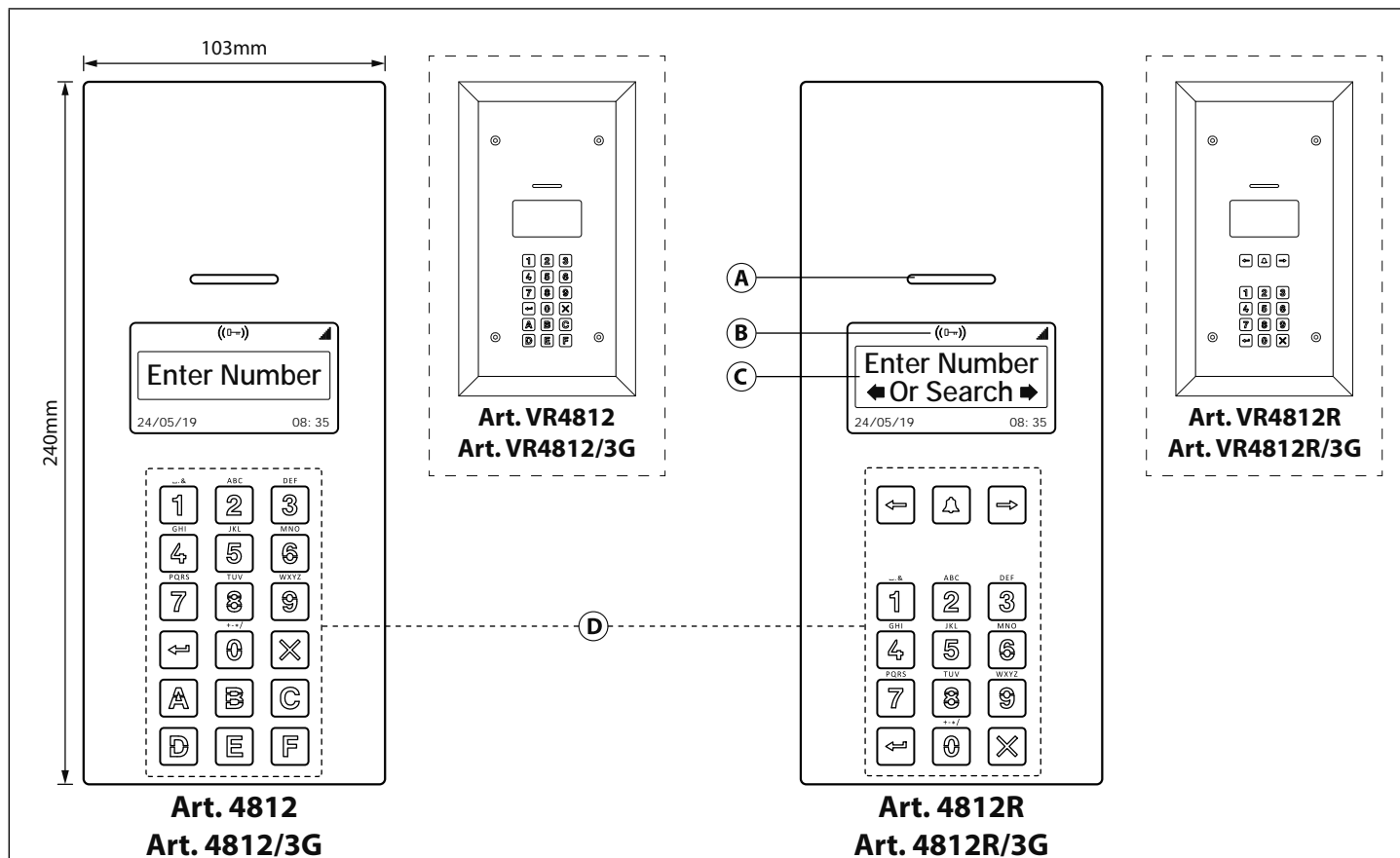

Fig. 9 - Front View

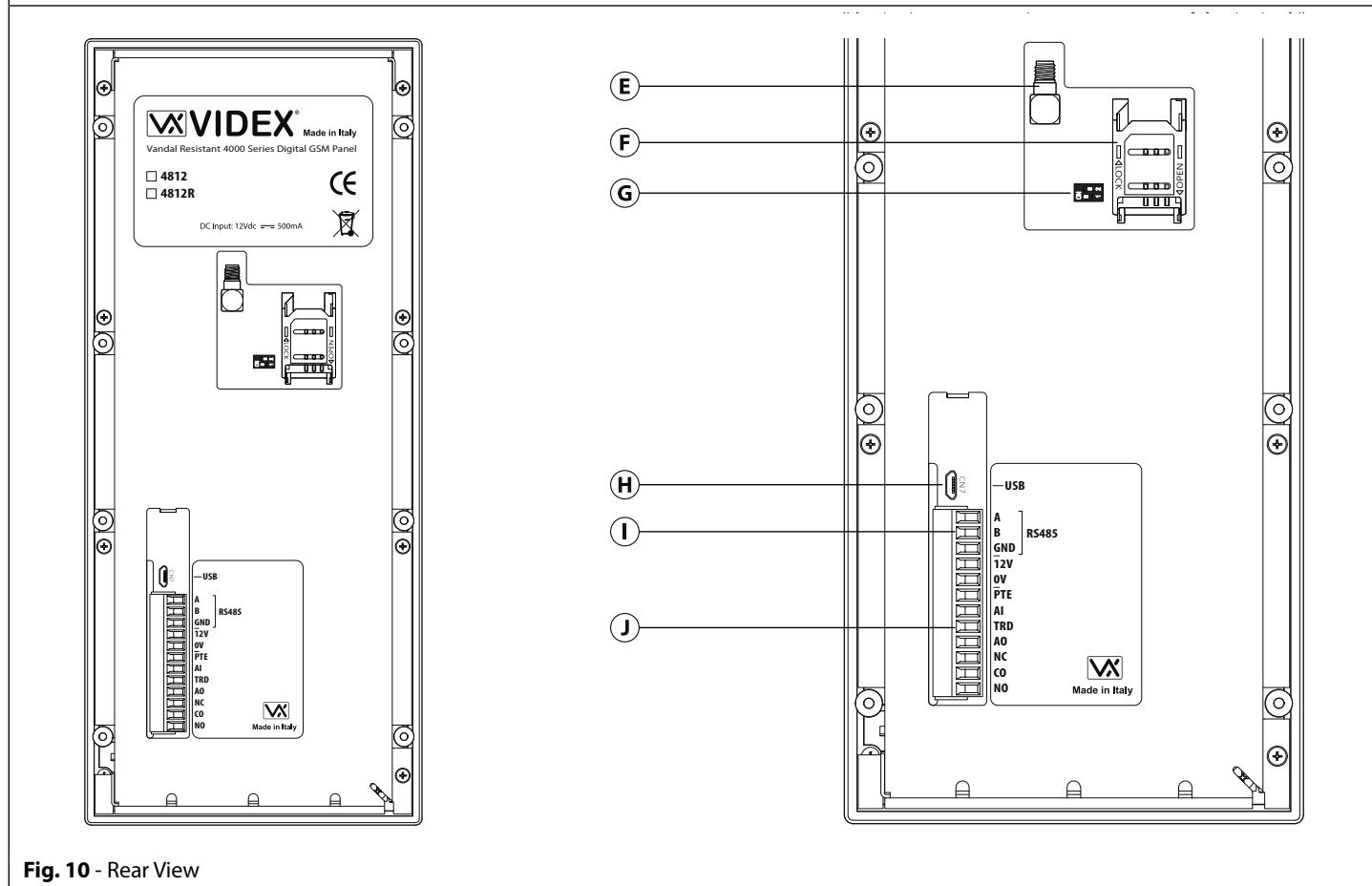





Fig. 10 - Rear View



## Art. 4812/4812R Technical Information

### SPEAKER VOLUME ADJUSTMENT (DIP-SWITCH SETTINGS)

There are 2 dip-switches located on the back of the digital GSM module next to the SIM card holder (**Fig.10**, **Ⓒ**). They can be used to adjust the volume from the door intercom speaker (see table below). Additionally, the volume can also be adjusted during a call electronically via the telephone keypad (refer to user command table 1 on page 66).

Dip-Switch	Dip-Switch Status		Gain (dB)
	Dip No.1	Dip No.2	
	ON	ON	6
	ON	OFF	12
	OFF	ON	18
	OFF	OFF	23.5

### LEGEND

- Ⓐ** Intercom speaker
- Ⓑ** Built-in proximity reader
- Ⓒ** 128x64 pixel graphical display
- Ⓓ** Keypad
- Ⓔ** SMA antenna connection
- Ⓕ** Sim card holder
- Ⓖ** Speaker volume dip-switches
- Ⓗ** Micro USB connection
- Ⓘ** RS485 bus terminals
- ⓵** Terminal connections

### TERMINAL CONNECTIONS

Terminal	Description	
<b>A</b>	RS485 A connection.	
<b>B</b>	RS485 B connection.	
<b>GND</b>	RS485 ground connection.	
<b>12V</b>	+12Vdc power (500mA max.).	
<b>0V</b>	0V ground power.	
<b>PTE</b>	Push to exit input (switched 0V).	
<b>AI</b>	Auxiliary input.	
<b>TRD</b>	Trade input.	
<b>AO</b>	Auxiliary output.	
<b>NC</b>	Normally closed relay connection.	Relay contacts: 3A@24Vdc 3A@120Vac
<b>CO</b>	Common relay connection.	
<b>NO</b>	Normally open relay connection.	

### TECHNICAL SPECIFICATION

<b>Working Voltage:</b>	12Vdc +/- 10%
<b>Standby Current:</b>	approx. 60mA
<b>Max. Current:</b>	approx. 500mA (max.)
<b>Number of Users:</b>	up to 500 (max.)
<b>Telephone Numbers (per apartment):</b>	4 telephone numbers (1 primary, 3 diverts)
<b>Dial to Open Numbers:</b>	up to 2000 (max.)
<b>Proximity Access (fobs/cards):</b>	up to 2000 (max.)
<b>Door/Gate Access Codes:</b>	up to 500 (max., 1 per user)
<b>Call button (phone ID) Timebands:</b>	10 (1 preset, 9 programmable)
<b>Free Access Timebands:</b>	10 (programmable)
<b>Programming:</b>	SMS messaging, Videx SMS wizard App. or PC software
<b>Push to Exit:</b>	1 (switched 0V input, across terminals PTE/0V)
<b>Auxiliary Input:</b>	1 (switched 0V input, across terminals AI/0V)
<b>Auxiliary Output:</b>	1 (AO, open collector output, switched 0V, 150mA max.)
<b>Trade Input:</b>	1 (switched 0V input), for connecting Art.701T timeclock
<b>Dry Contact Relay:</b>	1 (CO, NO and NC, 3A @ 24Vdc, 3A @ 120Vac)
<b>Event Log:</b>	up to 8000 events
<b>USB Port:</b>	micro USB
<b>RS485 Bus Connection:</b>	1 (A, B and GND), for connecting Art. 4850R expansion proximity reader
<b>Panel Dimensions:</b>	103mm (W) x 240mm (L) x 32mm (D)
<b>Working Temperature:</b>	-10 +50°C

# Wiring Diagrams

## LOCK RELEASE AND VOLT FREE CONNECTIONS

Fig.11 below shows connections for a fail secure and a fail safe lock release and also volt free contacts.

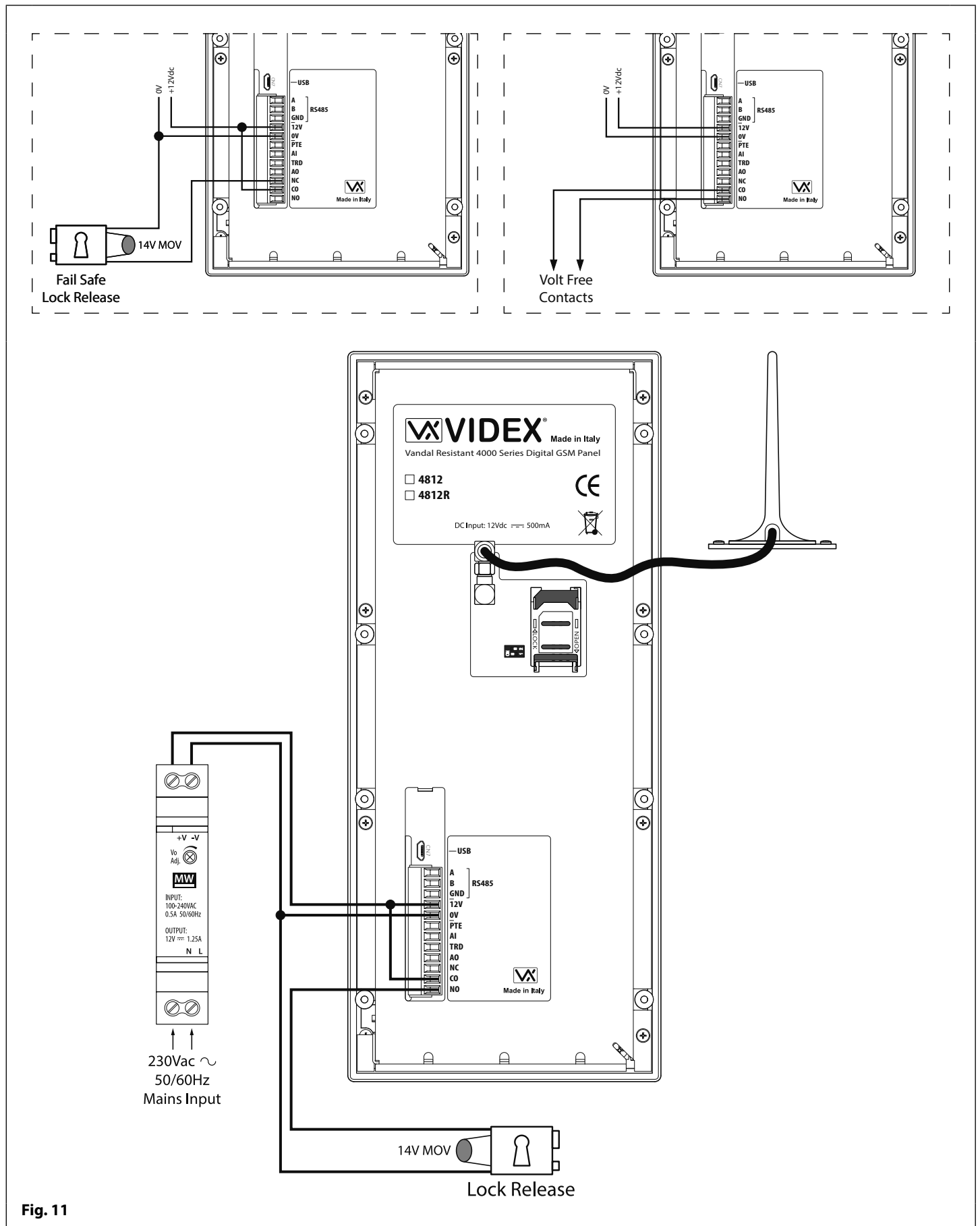

Fig. 11

## Wiring Diagrams

### TRADE INPUT AND PUSH TO EXIT INPUT CONNECTIONS

Fig.12 below shows connections for the trade input using an Art.701T timeclock (in timeclock mode) and Fig.13 shows connections for the push to exit input using a push-to-make (normally open going closed) switch/button.

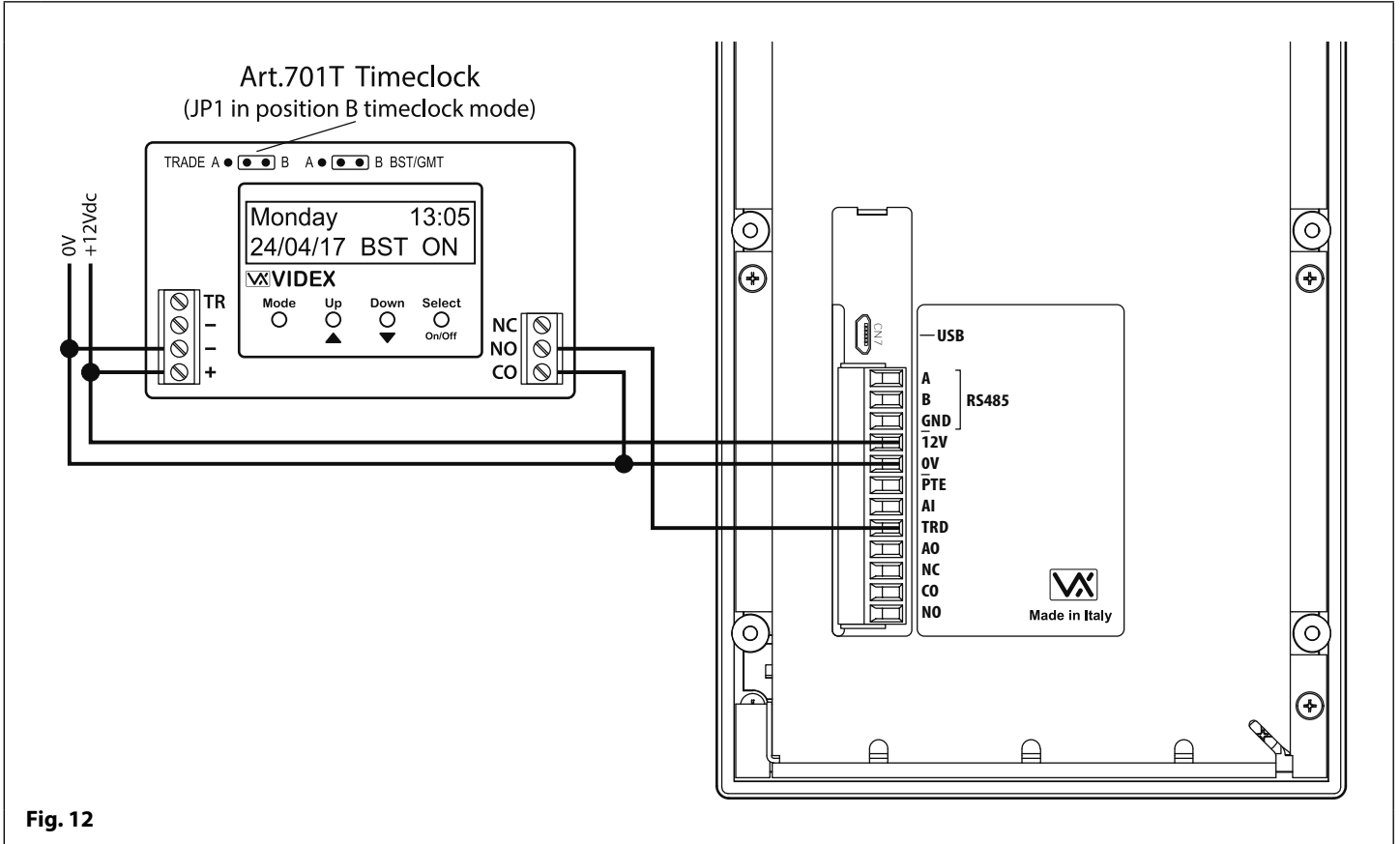

Fig. 12

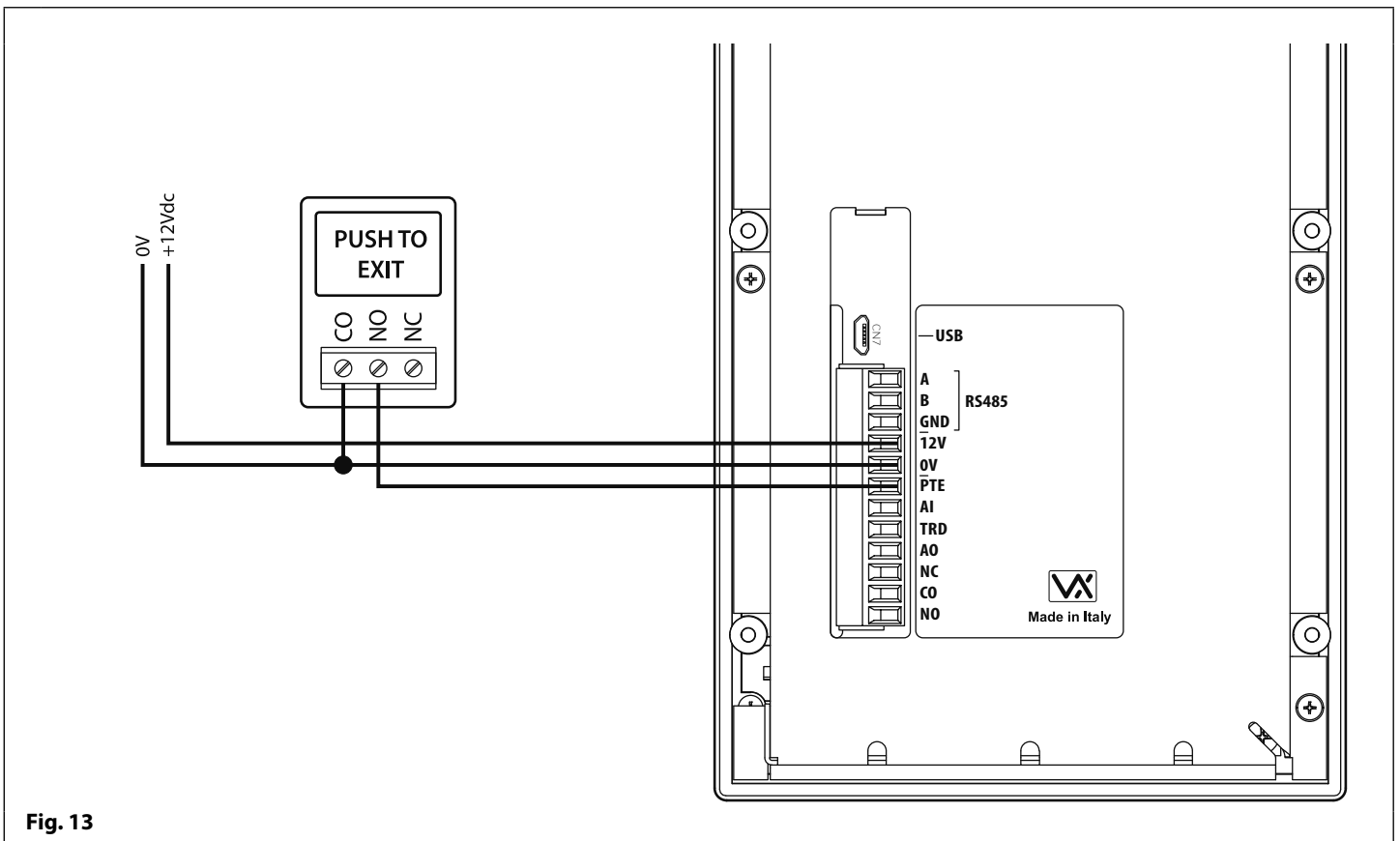
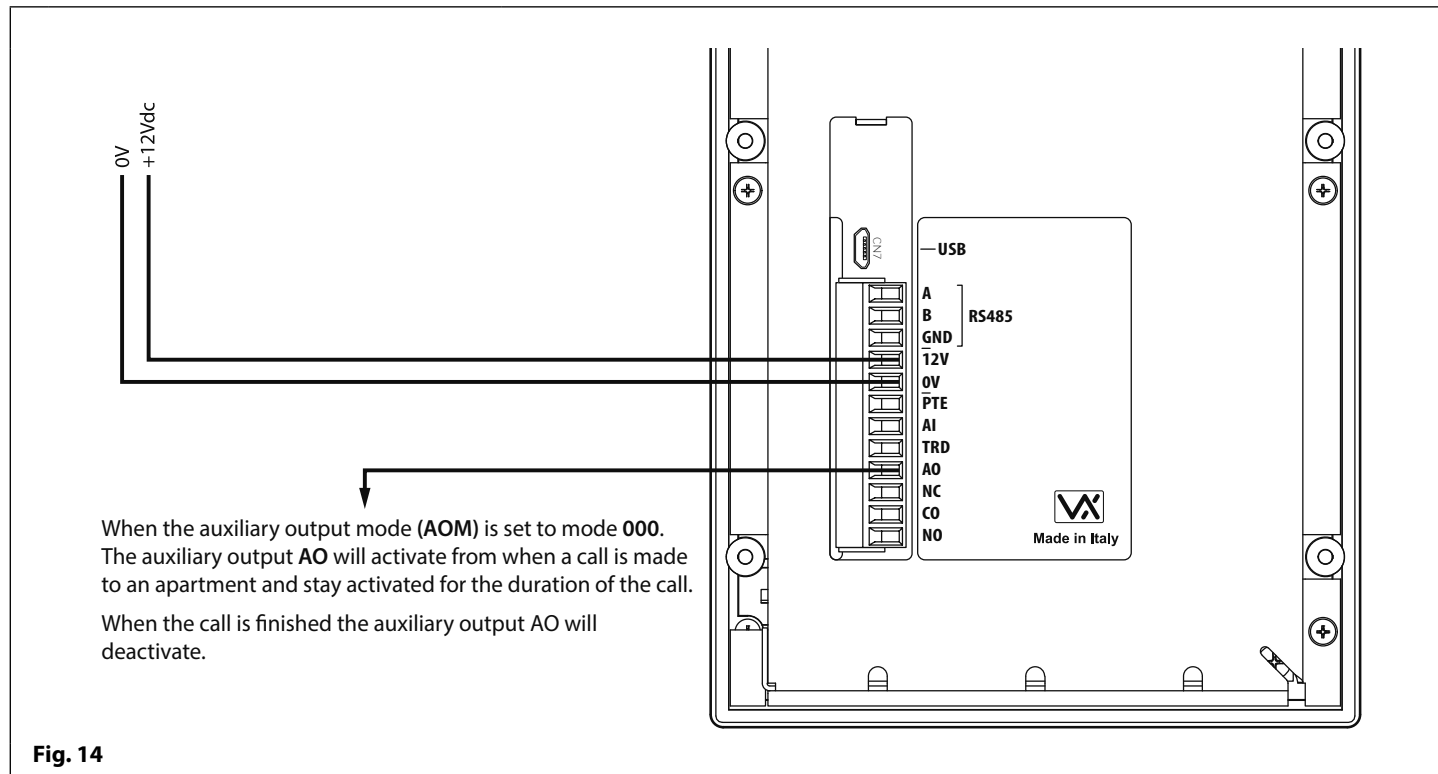

Fig. 13

# Auxiliary Input & Output

## AUXILIARY OUTPUT (AO) WHEN SET TO MODE 000 (ON DURING A CALL)

**Fig.14** below shows the connection for auxiliary output AO when the AOM mode is set to 000. The auxiliary output AO will activate once a call to an apartment has been made and will stay activated for the duration of the call.



## AUXILIARY INPUT (AI) AND AUXILIARY OUTPUT (AO) WHEN SET TO MODE 001 (ON WHEN TRIGGERED)

**Fig.15** below shows the connection for auxiliary output AO when the AOM mode is set to 001. The auxiliary output AO can be activated remotely by the user sending the text message 1111 A10 to the digital GSM intercom or by pressing 6 on the telephone during a call and will stay activated for the programmed auxiliary output time A1T. The auxiliary output can also be triggered by a normally open switch (switched 0V) connected into the auxiliary input AI.

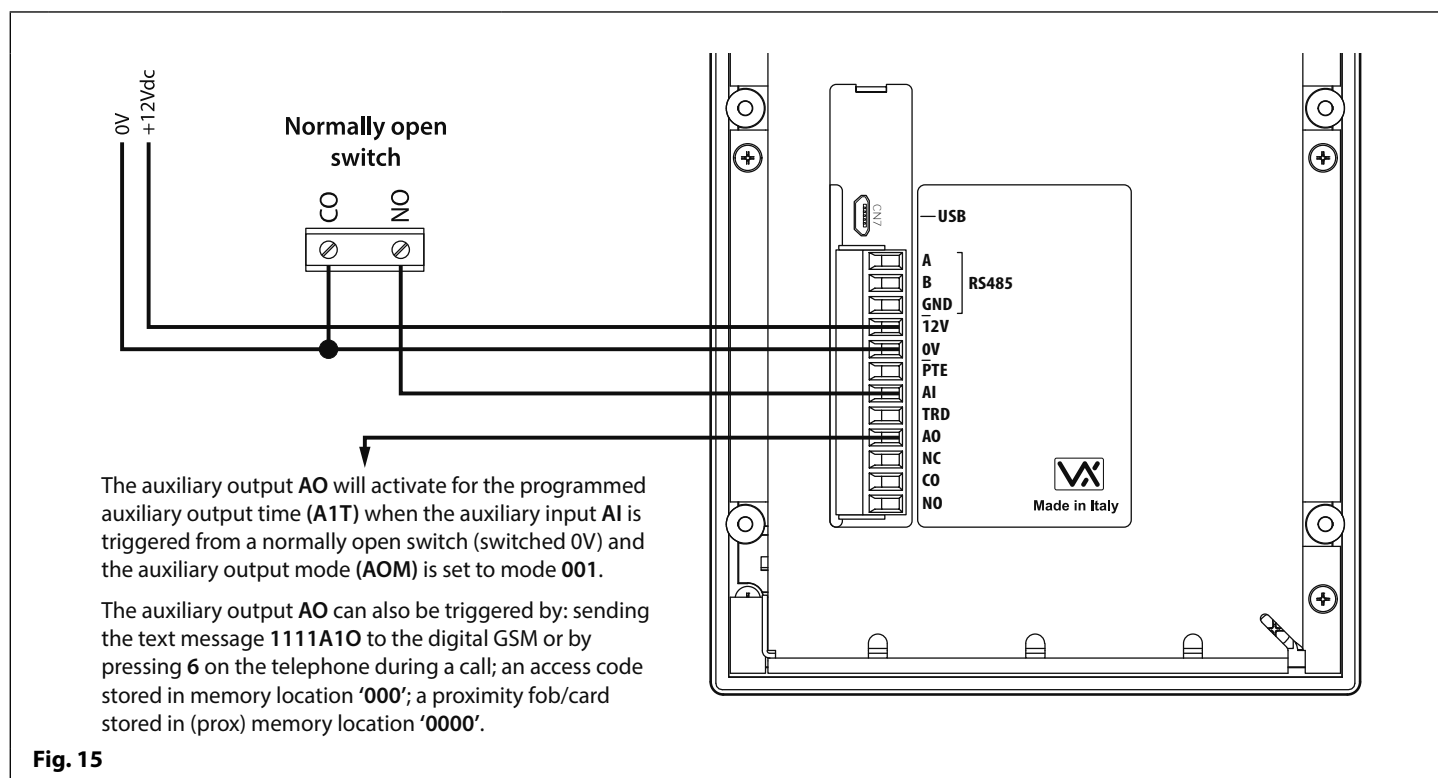

## Auxiliary Input & Output

### AUXILIARY OUTPUT (AO) WHEN SET TO MODE 002 (CALL ACTIVATED)

**Fig.16** below shows the connection for auxiliary output AO when the AOM mode is set to 002. The auxiliary output AO will activate once a call to an apartment has been made and will stay activated for the programmed auxiliary output time A1T.

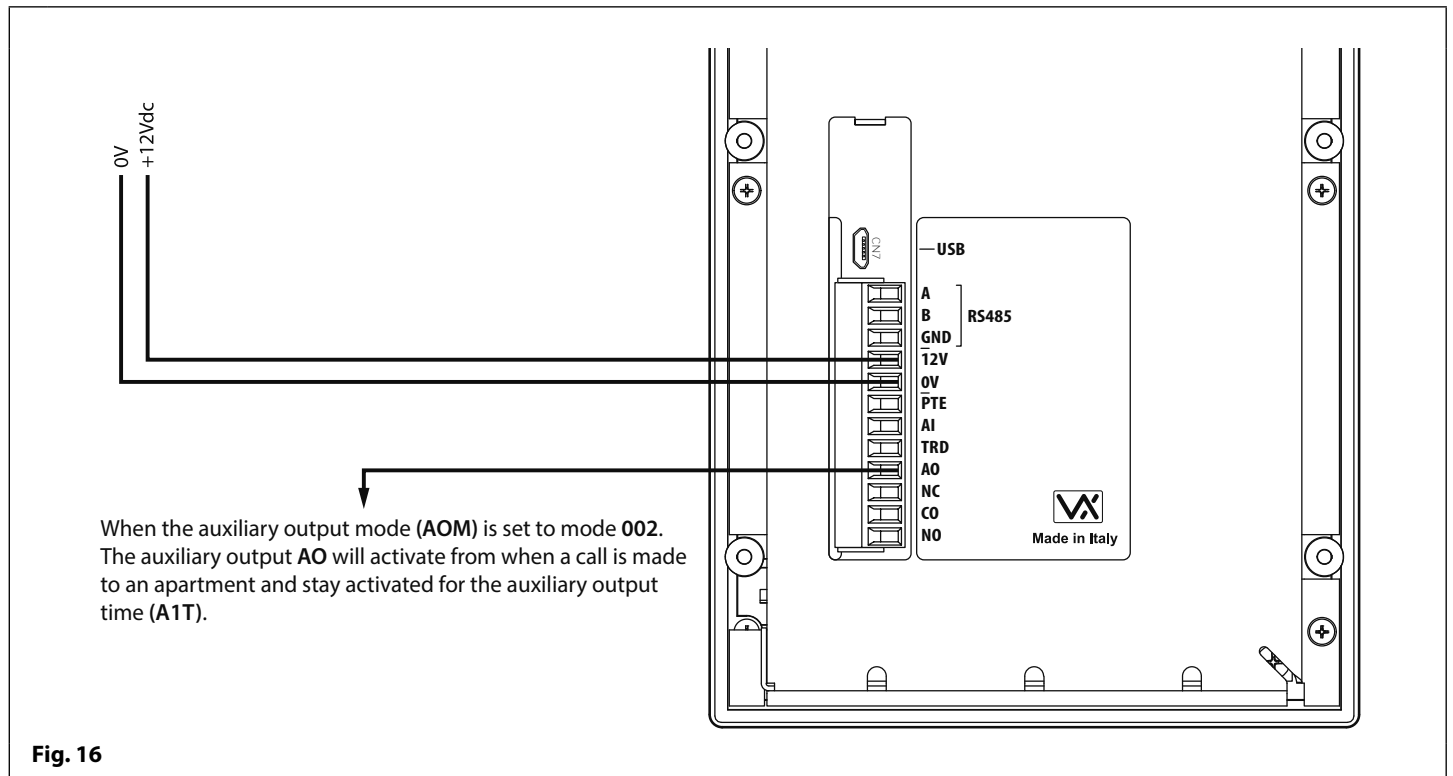

**Fig. 16**

### CONNECTING A SECONDARY DEVICE TO THE AUXILIARY OUTPUT (AO)

Since the auxiliary output AO is a transistor switched output (switched low output) it can be connected to a relay (e.g. an Art.506N). This is particularly useful if a secondary device requires triggering. **Fig.17** shows how to connect an Art.506N relay.

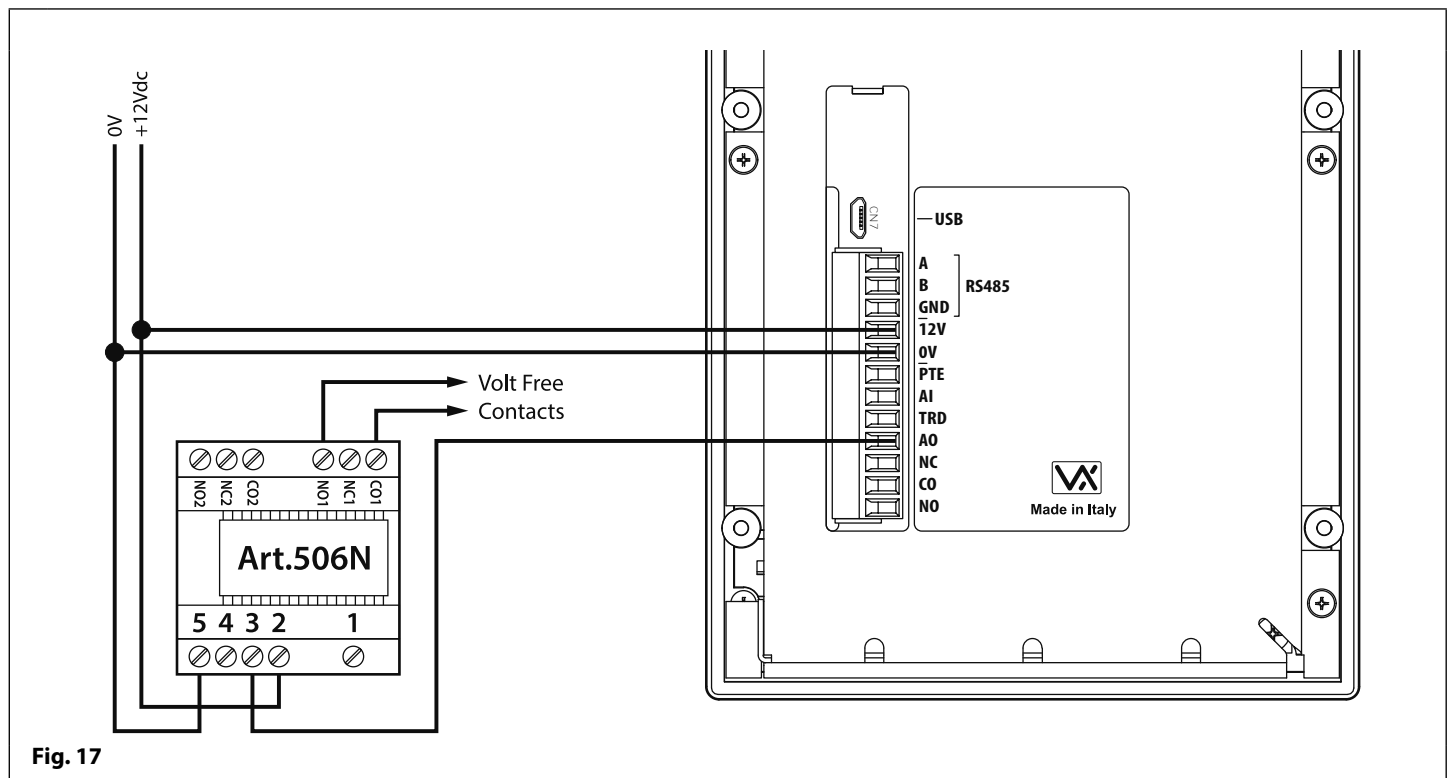

**Fig. 17**

# USB & RS485 Connection

## CONNECTIONS TO A PC

The digital GSM intercom also includes two options for connecting to a PC: via a USB connection or via an RS485 connection. Both methods of connection are to allow for ease of programming and monitoring using the GSMSK PC software. All programming features described in this manual are also accessible using the software. Further information on using the GSMSK PC software can be found in the technical manual [GSMSK\\_66251720\\_EN\\_V2-0](#) (or later).

### OPTION 1: USB CONNECTION

The digital GSM can be connected using a standard micro-USB to USB cable as shown in **Fig.18**. This method of connection is primarily used for programming and setup of the digital GSM panel.

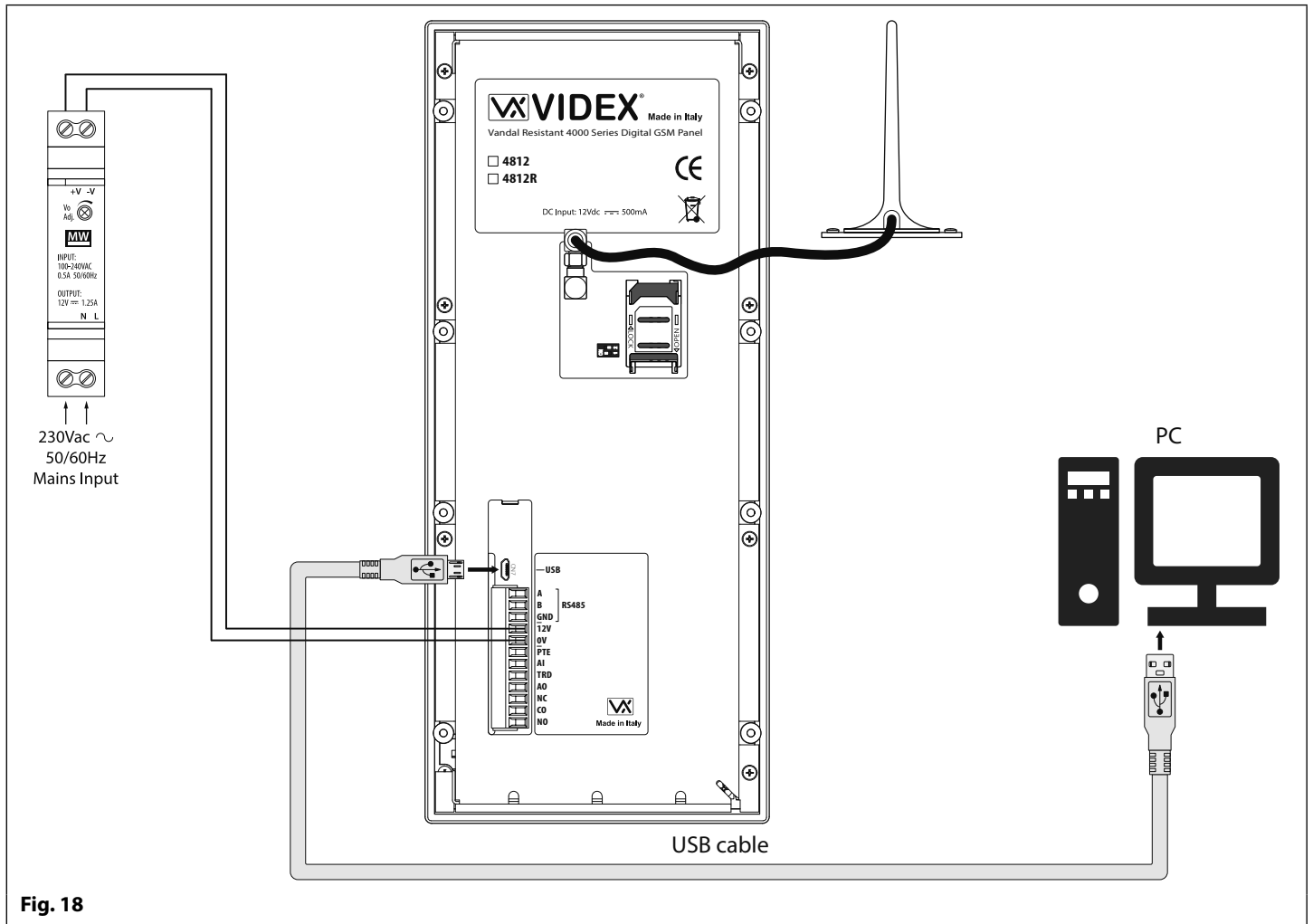

**IMPORTANT NOTE:** The USB port is not intended for a permanent connection to a PC and should only be used for programming purposes. If a permanent connection to a PC is required refer to RS485 notes on page 15, **Fig.19**.

## USB & RS485 Connection

### OPTION 2: RS485 CONNECTION

The digital GSM intercom can also be connected using an RS485 bus connection via an RS485 to USB converter (Art.481) as shown in **Fig.19**. This method of connection, like option 1, can be used for programming and setup of the digital GSM, but can also be used in instances where a permanent connection to a PC is required for monitoring purposes and downloading event logs. When connected in this way the digital GSM can only be connected as a 'one-to-one' bus connection to the PC, another GSM module **cannot** be connected on the same RS485 bus to the PC.

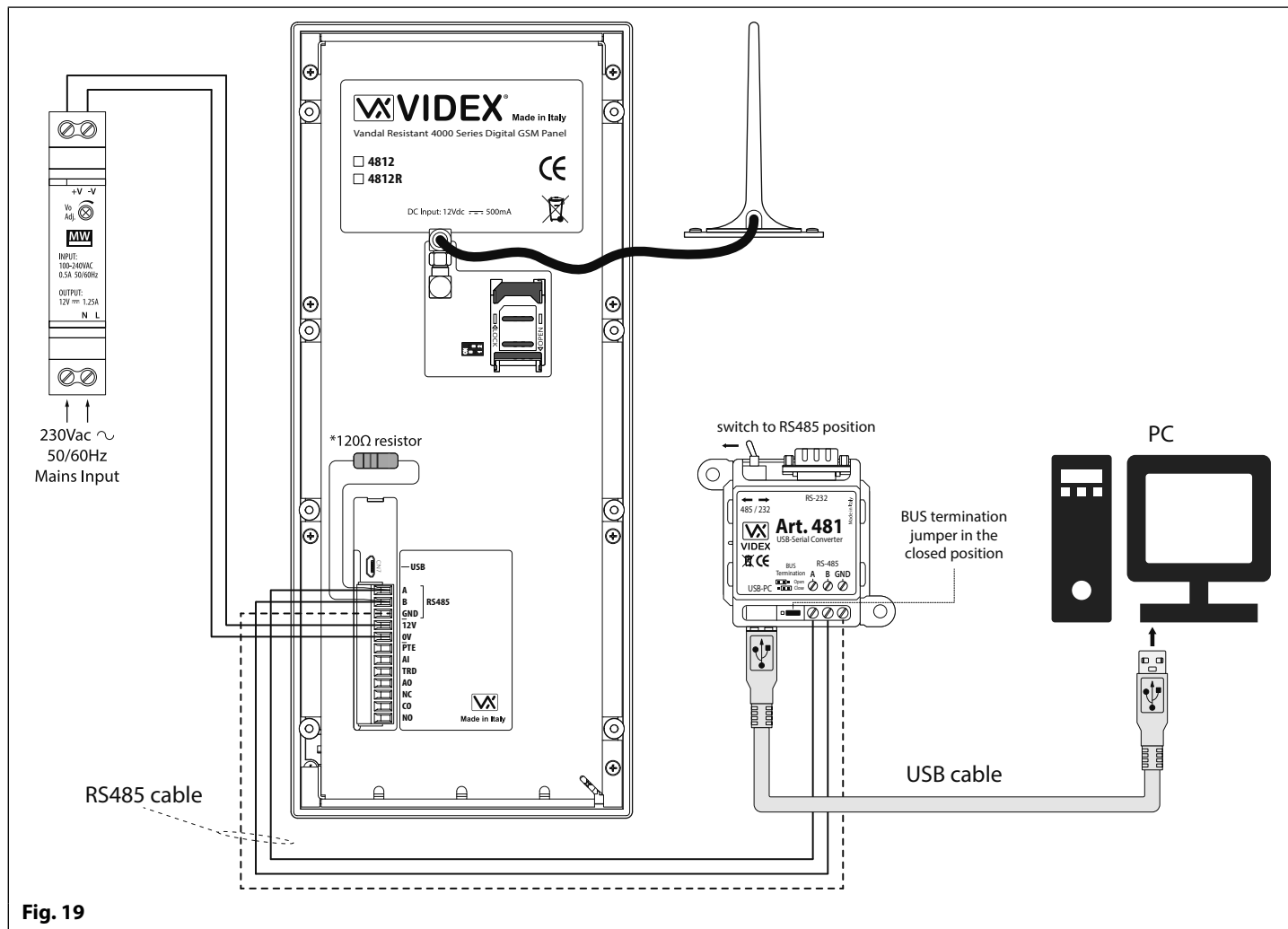

\*For end of line termination a 120Ω resistor must be fitted across the RS485 terminals A and B, as shown in **Fig.19**, but only if the digital GSM is the last device in line and over a great distance (500m max.). Over shorter distances the 120Ω resistor is not required and the bus termination jumper on the Art.481 can be set to the OPEN position.

# RS485 Bus Connection to an Art. 4850R

## CONNECTIONS TO AN ART. 4850R EXPANSION PROXIMITY READER

The RS485 bus terminals on the digital GSM can also be used to connect to an Art.4850R expansion reader, refer to **Fig.20**. When the Art.4850R is connected in this way it operates as a parallel reader with the built-in reader on the digital GSM, therefore when user fobs/cards are programmed into the digital GSM they can be used on both the built-in reader and on the Art.4850R expansion reader.

Programming fobs and cards via the digital GSM's keypad can be found on page 30 following the proximity menu flowchart, programming via text message can be found on pages 57 and 58. Alternatively programming of fobs and cards can be found in the technical manual: **GSMSK\_66251720\_EN\_V2-0** (or later) if using the GSMSK PC software.

## EXPANSION READER OPERATION

If a programmed fob/card is presented to the expansion reader it will **only** operate it's own relay and **not** the relay on the digital GSM, similarly if a programmed user fob/card is presented to the digital GSM's built-in reader it will **only** operate it's own relay and **not** the expansion reader's relay.

Further information on the expansion reader's operation can be found on page 65, **using an Art.4850R expansion reader**.

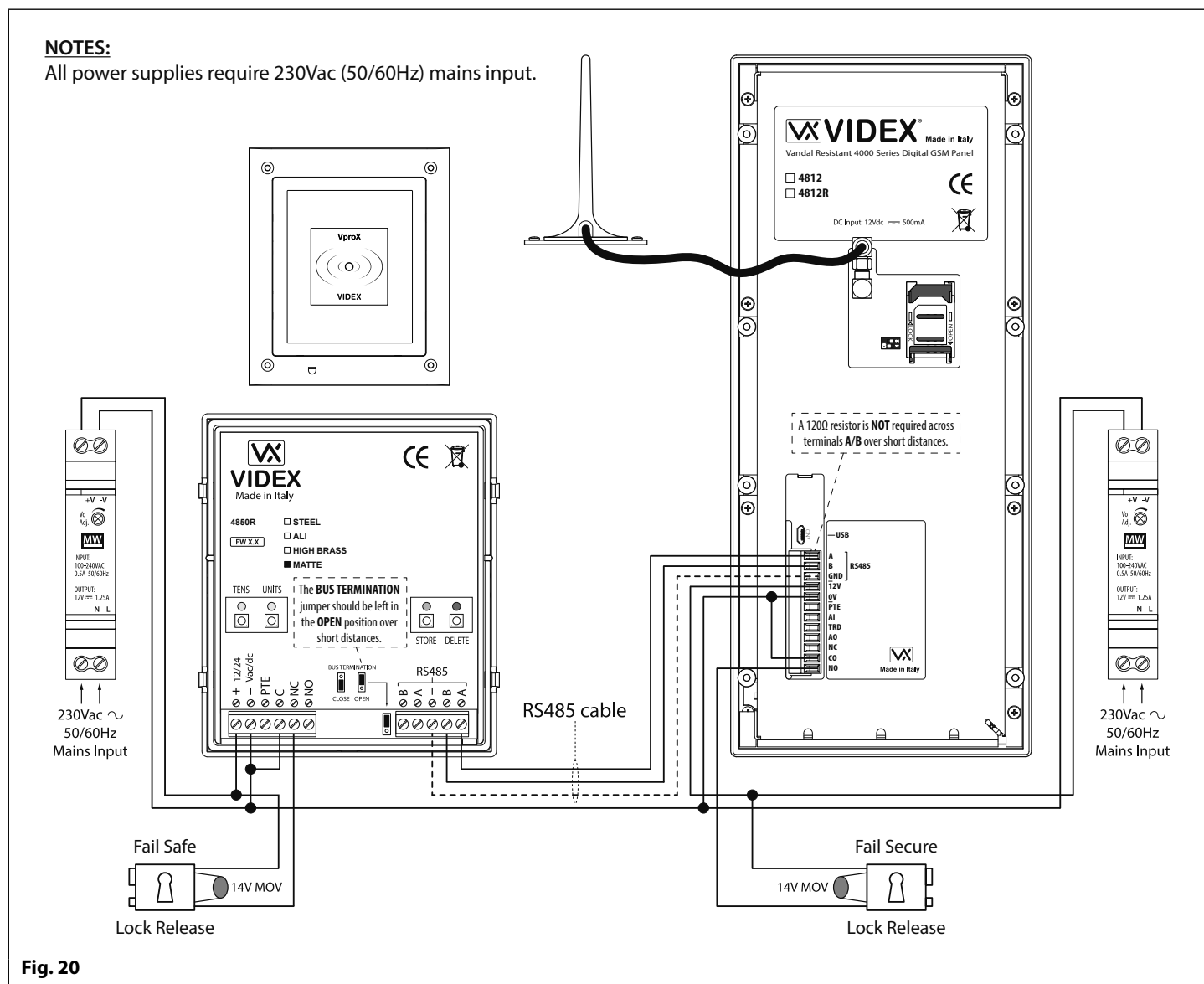

**Fig. 20**

**IMPORTANT NOTE:** For the RS485 bus cable over a short distance the bus termination on the Art.4850R should be set to the OPEN position (jumper in the upper position) and a 120Ω resistor is **NOT** required across terminals A/B on the digital GSM intercom, as shown in Fig.20 above. The RS485 bus termination jumper should only be set to the CLOSED position and a 120Ω resistor fitted across terminals A/B on the digital GSM over longer distances.

Information on the relay time setup for the Art.4850R can be found in the technical instructions: **4850R\_66250407\_EN\_V1-1** (or later).



# General Directions for Installation

## CABLE SIZE GUIDE

### POWER SUPPLY AND LOCK RELEASE CONNECTIONS

Refer to the table below for the connections for the power supply output to the digital GSM and the lock release connections.

Distance	20m	50m	100m
Cross Sectional Area (CSA)	0.5mm <sup>2</sup>	1.0mm <sup>2</sup>	1.5mm <sup>2</sup>

Ideally the power supply should be located as close to the intercom panel as possible for best performance. The maximum acceptable resistance for the above cables = 3Ω or less for best possible performance.

### RS485 CONNECTIONS

A CAT-5 cable is acceptable where 1 pair is used for the 0V/GND connection and a second pair is split between the A and B connections (i.e. 1 core of the pair is used for the A terminal, 1 core of the pair is used for the B terminal, see Fig.21).

The total overall distance between the first RS485 device in line, the Art.481 or digital GSM, and the last RS485 device in line, the Art.4850R, should be no more than 500m max. for the best possible performance, see Fig.22 and Fig.23. It is also important that the end of line RS485 bus termination of the Art.4850R is in the **CLOSED** position, in the case of the digital GSM a 120Ω resistor should be fitted across the A and B bus terminal connections (unless it's connected with an Art.481, in which case the bus termination jumper on the Art.481 should be in the **CLOSED** position as this would be the last RS485 device in line).

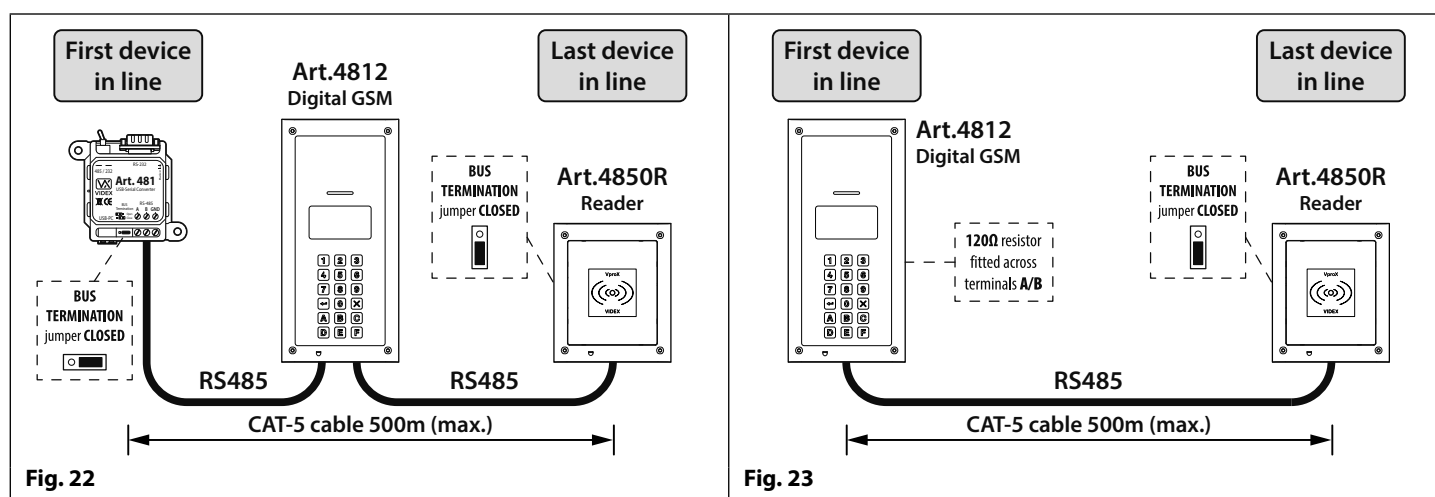
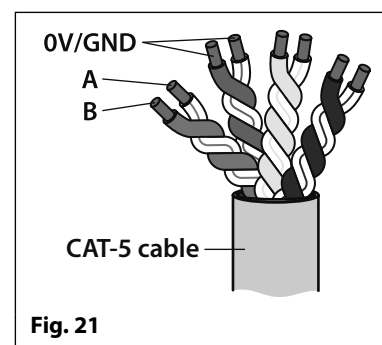

**IMPORTANT NOTE:** Only bare copper (BC) cable should be used (solid or stranded is acceptable). Please be aware that when selecting a cable the following should NOT be used: Copper Coated Steel (CCS) and Copper Clad Aluminium (CCA). While these types of cable may offer a low cost solution they will have a higher resistance than pure copper cable and can affect the overall performance of the system therefore Videx **DO NOT** recommend these types of cable.

### GENERAL INSTALLATION NOTES

- Check that all components are free from damage before installing (**do not proceed with installation in the event of damage**).
- Keep all packaging away from children (**please dispose of any excess waste and packaging responsibly**).
- **Do not obstruct** the ventilation openings or slots on any of the devices.
- All connections to mains voltages must be made to the current national standards (I.E.E. wiring regulations for the UK or the appropriate standards of your country if installing overseas).
- Install an appropriate fused spur or isolation switch to isolate the mains.
- Isolate the mains before carrying out any maintenance work on the system.
- Avoid water ingress into the rear of the module, always seal the module frame after installation using a suitable silicon based sealant.
- All intercom and access control cables must be routed separately from the mains (ideally in a separate cable tray or duct).

## General Directions for Installation

### LOCK RELEASE WIRING AND BACK EMF PROTECTION

When fitting an electric lock release back EMF protection will be required. If fitting an AC lock release then a 100nF ceramic disc capacitor should be fitted across the terminals of the lock, shown in **Fig.24**. If fitting a DC lock release (fail secure or fail safe) then a 1N4002 diode should be fitted across the terminals on the lock, shown in **Fig.25**.

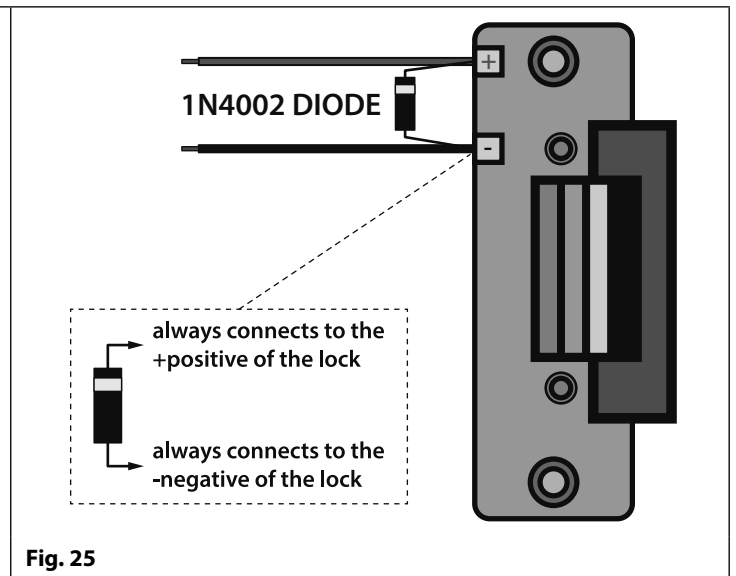
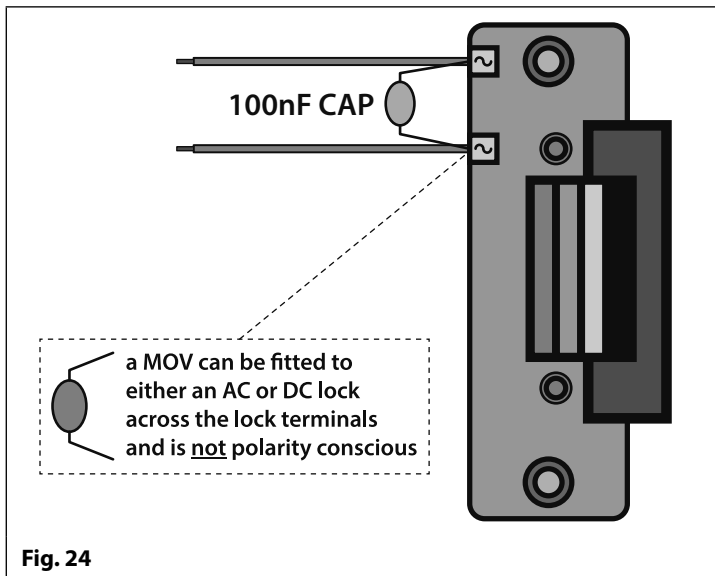

If a 100nF ceramic disc capacitor or a 1N4002 diode are not available then a 14 - 20V MOV (metal oxide varistor) can be fitted across the lock terminals instead (refer to **Fig.24** above) and can be fitted on both an AC and DC lock. Connection examples can also be seen on the various wiring diagrams on pages 10 and 11.

### CONNECTION TO MAINS, SAFETY AND GUIDANCE NOTES

**⚠ IMPORTANT: PLEASE READ THESE INSTRUCTIONS CAREFULLY BEFORE COMMENCING WITH THE INSTALLATION.**

**⚠ IMPORTANT: IT IS RECOMMENDED THAT ANY CABLING AND VIDEX PRODUCTS BE INSTALLED BY A COMPETENT AND QUALIFIED ELECTRICIAN, SECURITY INSTALLATION SPECIALIST OR COMMUNICATIONS ENGINEER.**

- **DO NOT** install any Videx product in areas where the following may be present or occur:
- Excessive oil or a grease laden atmosphere.
- Corrosive or flammable gases, liquids or vapours.
- Possible obstructions which would prevent or hinder the access and/or removal of the Videx product.

### MAINS CONNECTION

The system **MUST** be installed in accordance with the current I.E.E. regulations (in particular I.E.E. Wiring regulations BS7671 for the UK), or the appropriate standards of your country if installing overseas, in particular Videx recommends:

- Connecting the system to the mains through an all-pole circuit breaker (refer to **Fig.26**) which shall have contact separation of at least 3mm in each pole and shall disconnect all poles simultaneously.
- That the all-pole circuit breaker shall be placed in such a way to allow for easy access and the switch shall remain readily operable.
- Ensuring that the mains supply (Voltage, Frequency and Phase) complies with the product rating label (this is usually located on the top side of the power supply).
- Isolating the mains before carrying out any maintenance work on the system.

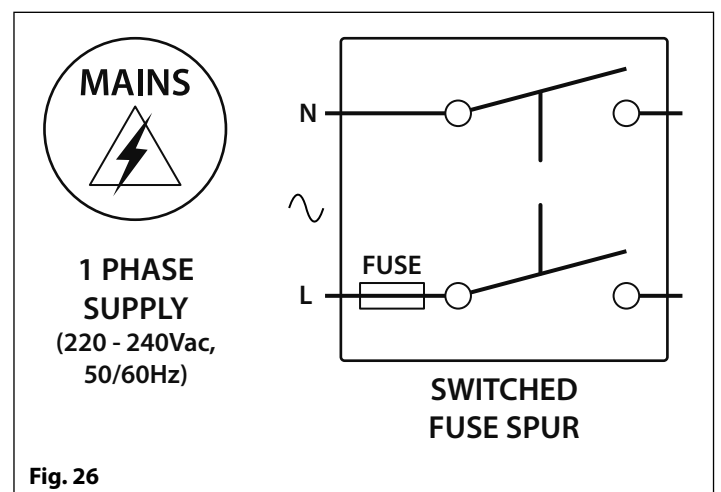

## General Directions for Installation

### POWER SUPPLY INSTALLATION

Follow the steps below when fitting the HDR-15-12 (12Vdc 1.25A) power supply.

- Fix the power supply to a DIN rail (following **Fig.27**, **Fig.28** and **Fig.29**).
- Switch **OFF** the mains using the circuit breaker (mentioned previously) and then make the connections as required shown on the various wiring diagrams throughout this manual.
- Check the connections and secure the wires into the terminals ensuring that the low voltage (signal) cables are routed separately from the high voltage (mains) cables.
- If applicable replace the terminal covers and fix them back into place using the relevant screws.
- When all connections are made restore the mains supply.

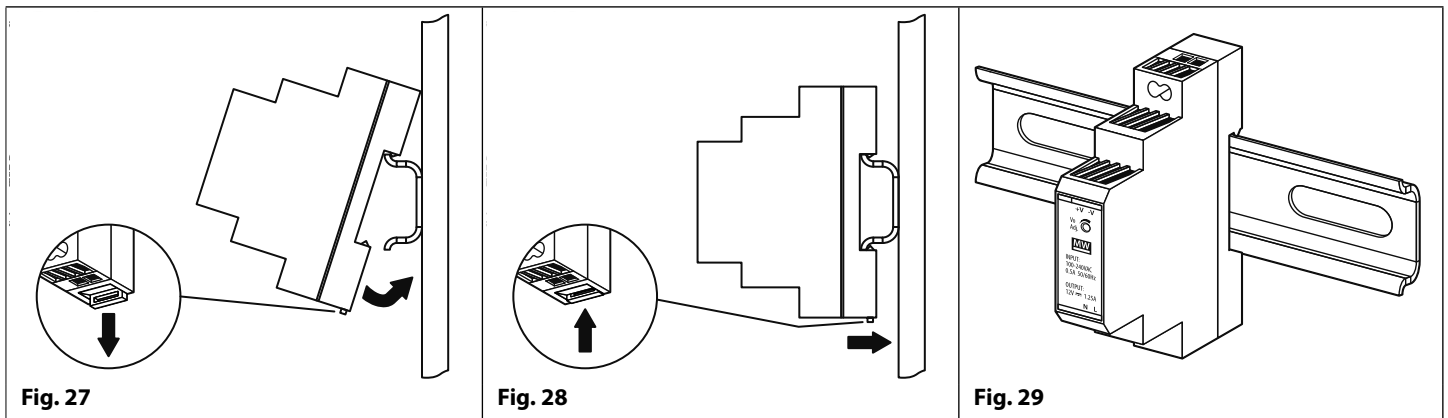

### PANEL CARE

The digital GSM's fascia is manufactured from brushed stainless steel. It is important that the fascia is cleaned on regular occasions to prevent dirt build up and tarnishing of the metal.

A clean and soft cloth can be used with moderate warm water or non-aggressive cleansers. Additional care should be taken to follow the grain of the metalwork when polishing panels with a brushed stainless steel finish and always only polish in one direction to avoid light scratching of the plate, see **Fig.30**. Also try to avoid any polish build up around the panel's buttons which may prevent the buttons from operating correctly.

#### DO NOT USE ANY OF THE FOLLOWING:

- Abrasive liquids;
- Chlorine-based liquids;
- Metal cleaning products (including Sidol stainless steel cleaner as this can affect the etching and/or engraving);
- Hydrochloride bleaches.

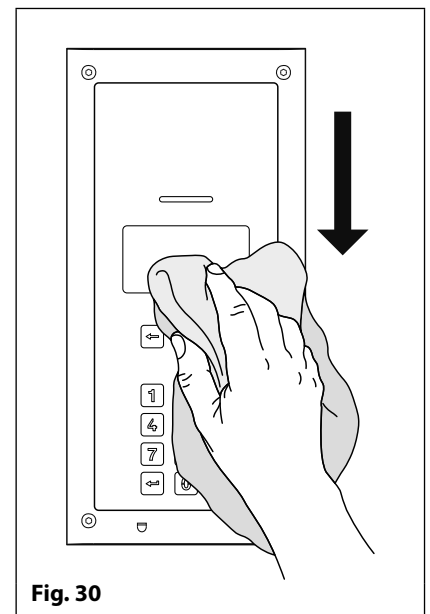

**⚠ IMPORTANT NOTE: IT IS IMPORTANT TO REGULARLY MAINTAIN THE "UP KEEP" OF THE GSM PANEL (CLEANING AND GENERAL MAINTENANCE ETC.) ANY FAULT OR DAMAGE THAT MAY OCCUR TO THE GSM PANEL DUE TO THE LACK OF CLEANING AND MAINTENANCE IS NOT THE RESPONSIBILITY OF VIDEX.**

# Fitting the SIM & Connecting Power

## FITTING THE SIM CARD AND CONNECTING THE POWER TO THE GSM INTERCOM

After connecting the power supply, antenna, lock output and any auxiliary devices as shown in this manual and before powering up, a SIM card must be installed (the SIM must already be registered with the network provider). The SIM holder can be found on the back of the module under the SMA antenna connection. A SIM card from most network providers can be used (remember a network 3 SIM will only work with the 3G version of the digital GSM intercom). Follow the steps below to insert the SIM card.

### FITTING THE SIM

1. First slide the SIM holder on the back of the digital GSM module down until it 'clicks', as shown in **Fig.31**.
2. The SIM holder is hinged and will open out, see **Fig.32**.
3. Place the SIM card into the holder (it will only fit one way, see **Fig.33**) and fold the holder back down, see **Fig.34**.
4. Slide the SIM holder back up until it 'clicks', see **Fig.35**.
5. Once the SIM is in place connect the Art.432 GSM antenna and then connect the 12Vdc power supply but **DO NOT** power up the system yet.
6. Follow the initialisation process below.

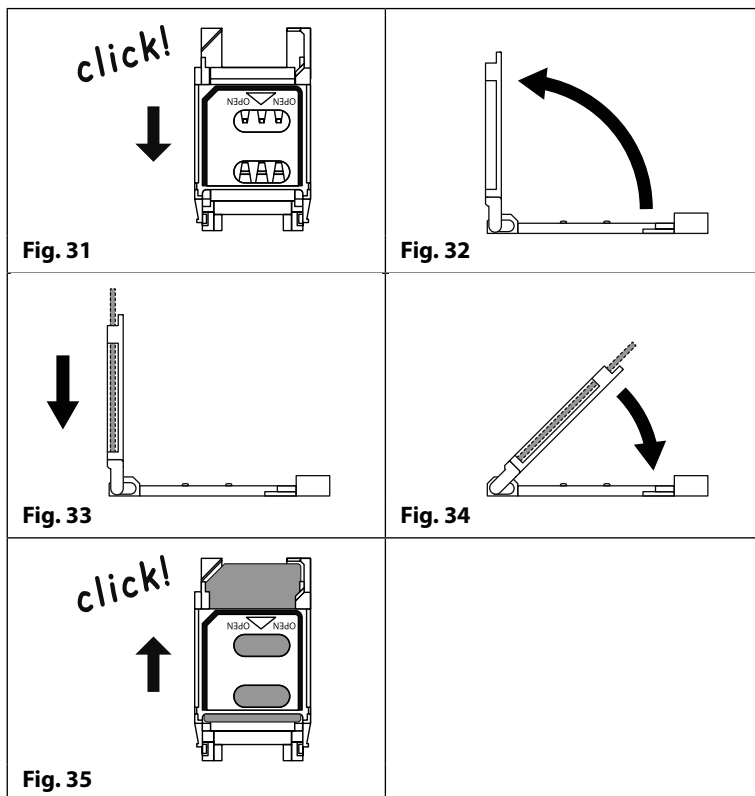

### POWER UP INITIALISATION SEQUENCE

The digital GSM intercom requires approximately 25 - 30 seconds too initialise properly. We recommend **NOT** sending any SMS messages or pressing buttons during this time.

1. First check all the connections have been made correctly and then power up the system.
2. The graphical display and the keypad buttons will illuminate.
3. After approximately 5 seconds the display will show the Videx GSM logo and current firmware version number, as shown in **Fig.36**.
4. After a further 10 seconds the GSM will emit a beep and below the Videx logo it will indicate the digital GSM is registering with the network, as shown in **Fig.37**.
5. After a further delay the display will then show the default welcome screen, refer to **Fig.38** for the Art.4812 and **Fig.39** for the Art.4812R below. The digital GSM is ready to begin programming.

The date and time is shown along the bottom of the display and the signal is indicated at the top right corner of the display.

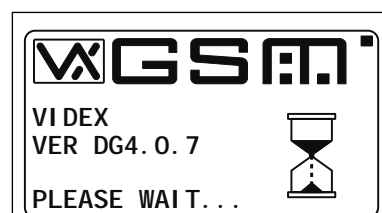

**Fig. 36**



**Fig. 37**

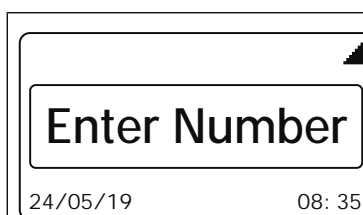

**Fig. 38**

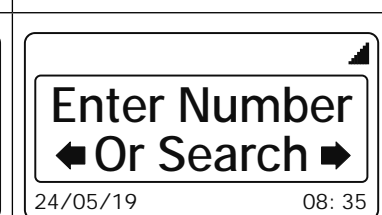



**Fig. 39**

# Reset Procedure

## RESETTING THE DIGITAL GSM INTERCOM TO FACTORY DEFAULTS

There are two reset procedures for the digital GSM panel. The first will reset the master code only and the second will reset everything and clear all stored telephone numbers, proximity cards and settings.

### RESETTING THE MASTER CODE TO 1111 (4x1)

1. Ensure the power is switched off to the digital GSM panel.
2. Press and hold down the '0' button, , and keep it pressed down while the power is switched back ON.
3. The graphical display and the keypad buttons will illuminate.
4. After a brief delay the display will show the Videx GSM logo and current firmware version number, as shown in **Fig.40**.
5. After another delay the GSM will emit a beep and below the Videx logo it will indicate the digital GSM is registering with the network, as shown in **Fig.41**.
6. When the display shows that it is registering release the '0' button, .
7. After a further delay the display will then show the default welcome screen (refer to **Fig.38** for the Art.4812 and **Fig.39** for the Art.4812R on page 20).
8. The master code has been reset back to factory default 1111 (4x1).

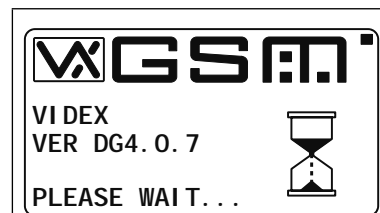



Fig. 40



Fig. 41

### FULL SYSTEM RESET

1. Ensure the power is switched off to the digital GSM panel.
2. On the rear of the GSM panel link out the GND and PTE terminals, as shown in **Fig.42**.
3. Press and hold down the 'ENTER' button, , and keep it pressed down while the power is switched back on.
4. The graphical display and the keypad buttons will illuminate.
5. After a brief delay the display will show the Videx GSM logo and current firmware version number, as shown in **Fig.43**.
6. After another delay the GSM will emit a beep and below the Videx logo it will indicate the digital GSM is resetting, as shown in **Fig.44**.
7. When the display shows that it is resetting release the 'ENTER' button, .
8. After a further delay the digital GSM will automatically follow the 'power up initialisation sequence' as described on page 20.
9. The digital GSM panel has been fully reset.

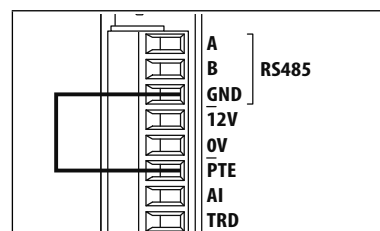

Fig. 42



Fig. 43

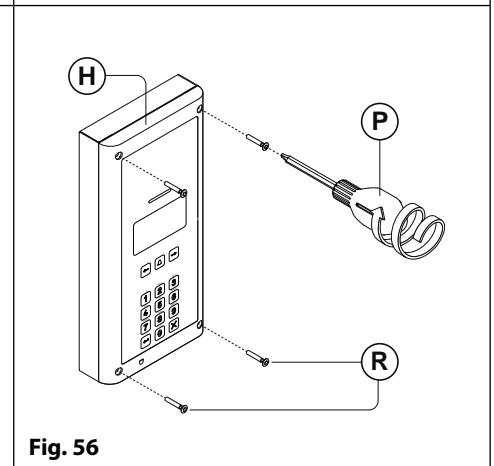
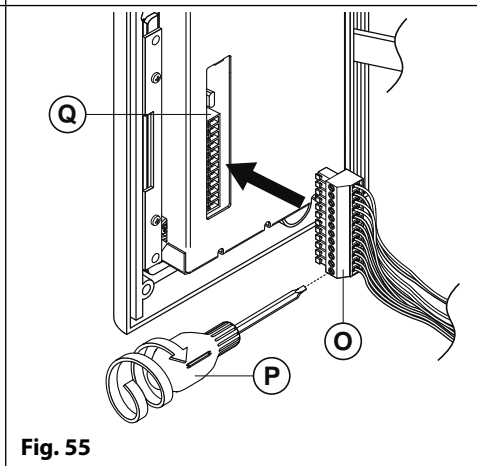
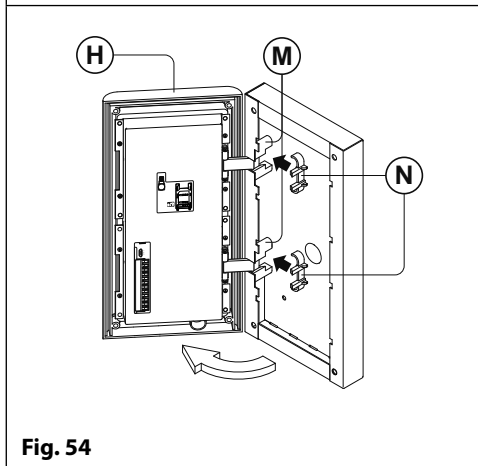
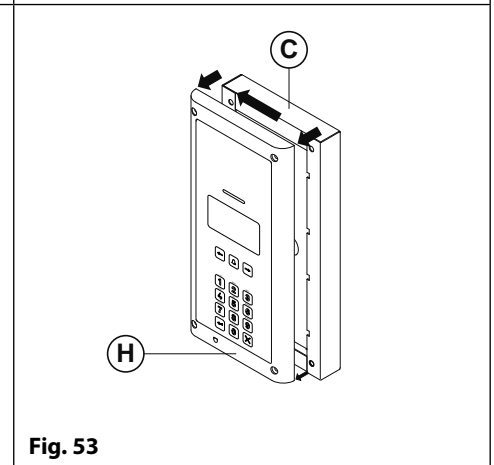
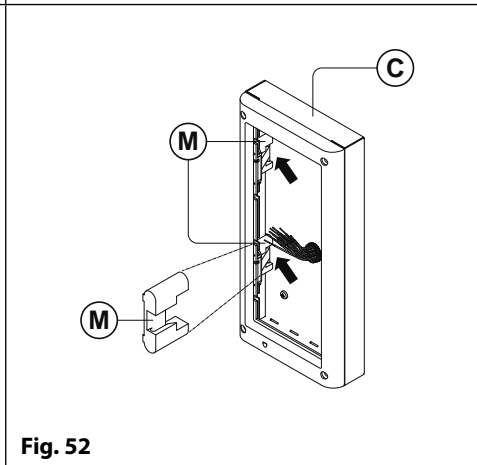
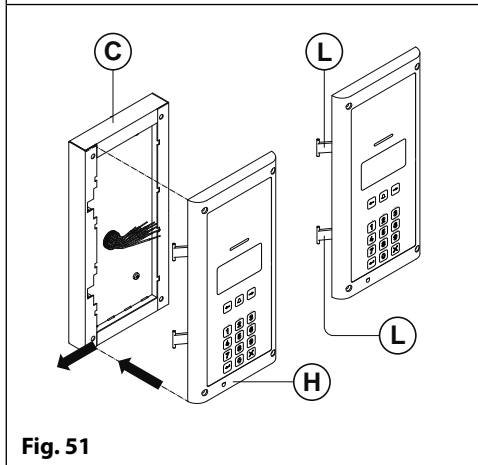
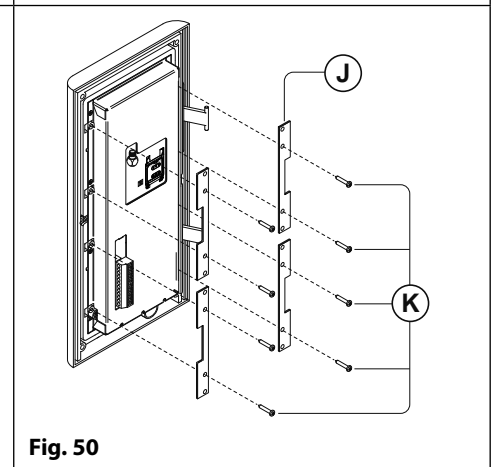
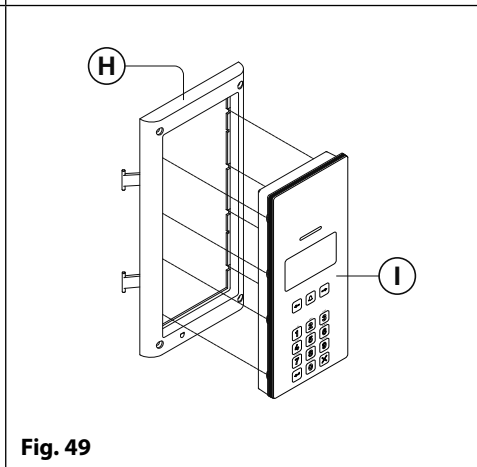
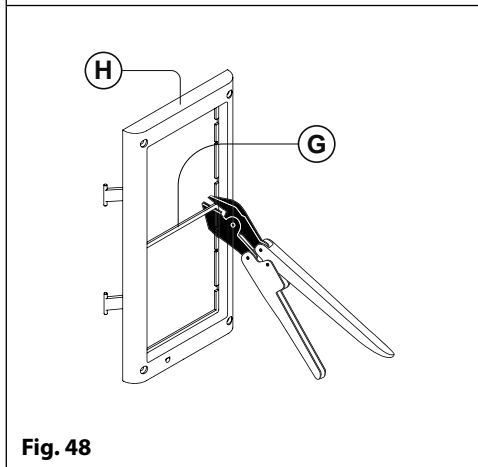
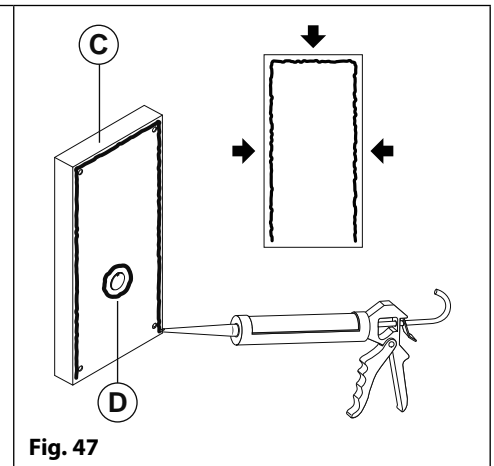
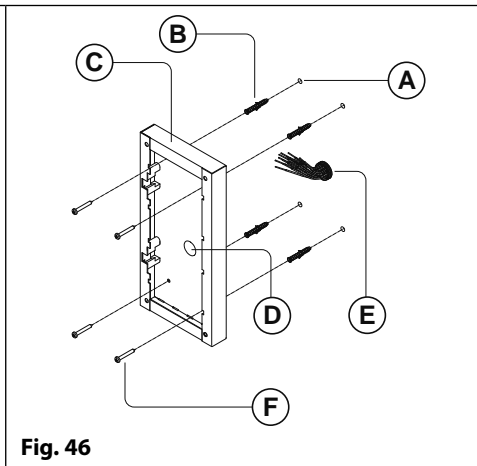
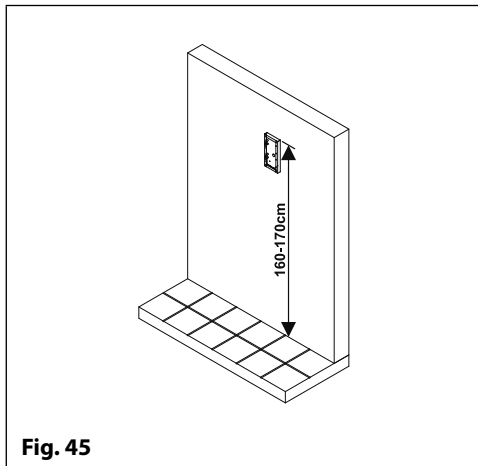

Fig. 44

**IMPORTANT NOTE:** When performing a full system reset all the data stored in the digital GSM will be deleted from the panel. If any data is still required it is recommended that this information is first downloaded from the digital GSM using the GSM SK PC software and then saved. It can then later be uploaded back into the digital GSM after the full reset has been completed.

# 4000 Series Back Box Installation

EXAMPLE: INSTALLING A 4000 SERIES TWO MODULE SURFACE BACK BOX (ART. 4882)



## 4000 Series Back Box Installation

### INSTALLING A SURFACE MOUNT DOOR STATION

1. Place the surface box against the wall (165-170cm between the top of the box and the floor level as shown in **Fig.45**) and mark the fixing holes **(A)** for the wall plugs **(B)** and the hole for the cables **(E)** (**Fig.46**). Observe the orientation of the box with the hinge mount **(M)** on the left;

 **In order to prevent water ingress we highly recommend using a silicon sealant between the wall and the back box **(C)**, ON THE LEFT, TOP AND RIGHT SIDES ONLY AND AROUND ALL THE HOLES **(D)** . DON'T USE SILICON SEALANT ON THE BOTTOM SIDE OF THE BACK BOX (**Fig.47**);**

2. As shown in **Fig.46**, drill the fixing holes **(A)** , insert the wall plugs **(B)** and feed the cables **(E)** through the surface box opening **(D)** , fix the surface box **(C)** to the wall using the screws **(F)** ;
3. Remove the cross bar **(G)** from the module support frame **(H)** using the appropriate hand tool (where required it may be necessary to wear the appropriate clothing, e.g. protective gloves and eye protection, when doing this) as shown in **Fig.48**;
4. Before installation of the module support frame **(H)** to the surface box **(C)** , fit the module **(I)** to the support frame **(H)** as shown in **Fig. 49** then, as shown in **Fig.50**, fit the module fixing brackets **(J)** using the fixing screws **(K)** ;
5. Next take the frame's hinges **(L)** and hook the module support frame **(H)** to the surface box **(C)** , starting from the left following the guide arrows, as shown in **Fig.51**. Ensure that the frame's hinges **(L)** (**Fig.51**) fit inside the relevant hinge mounts **(M)** inside the surface box **(C)** , following the guide arrows, as shown in **Fig.52**;
6. Pull back the module support frame **(H)** from the surface box **(C)** while moving it slightly to the left, following the guide arrows, as shown in **Fig.53**;
7. Next open the module support frame **(H)** and clip the hinge locks **(N)** to the hinge mounts **(M)** , following the guide arrows, as shown in **Fig.54**;
8. Make the required wiring connections into the terminal block **(O)** using the screwdriver provided **(P)** (using the flat blade end) then plug the terminal block **(O)** into the module's terminal block connector **(Q)** , as shown in **Fig.55**. Make any other necessary panel adjustments required (connecting the antenna cable, fitting the SIM card and setting the dip-switches etc.);
9. After the system has been tested and is working correctly, move back the module support frame **(H)** carefully and then fix it to the surface box **(C)** using the screwdriver provided **(P)** (using the torx end) and the torx pin security screws provided **(R)** , as shown in **Fig.56**. **Note: do not over tighten the screws more than is necessary.**

 **Note: if additional holes are made in the surface box, oxidation problems may appear unless the unprotected metal is coated with a protective paint.**

# 4000 Series Back Box Installation

## EXAMPLE: INSTALLING A 4000 SERIES TWO MODULE FLUSH BACK BOX (ART. 4852)

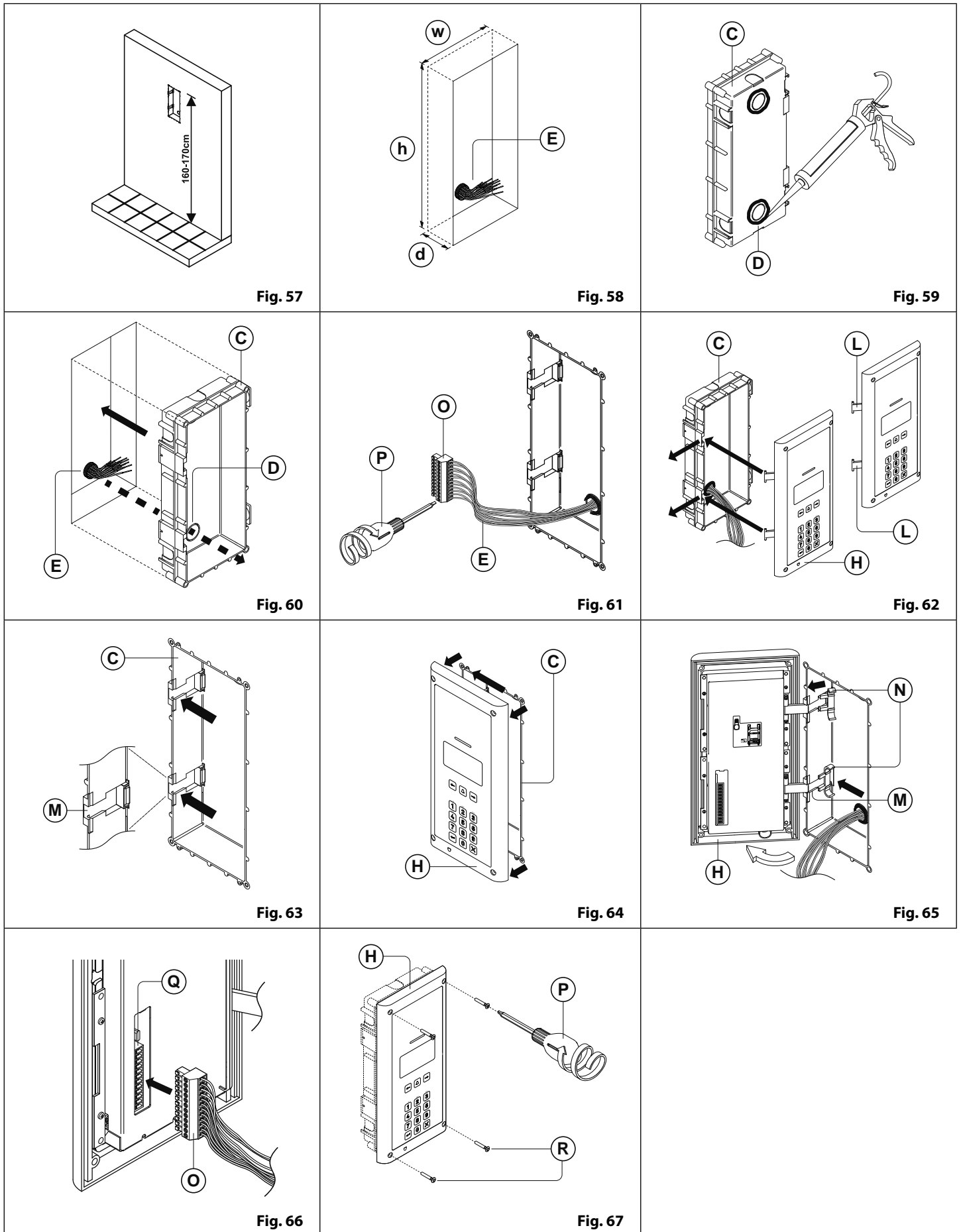



## 4000 Series Back Box Installation

### INSTALLING A FLUSH MOUNTING DOOR STATION

1. It is recommended that the flush box (C) is mounted into the wall approximately 165-170cm between the top of the box and the floor level as shown in **Fig.57**.
2. Using the flush box (C) and the hole dimensions (**w=120mm x h=263.2mm x d=46mm**), as shown in **Fig.58**, use appropriate tools to cut out the recommended hole size in the wall (where required it may be necessary to wear the appropriate clothing, e.g. protective gloves and eye protection, when doing this). Remember to allow room for the connecting cables (E) (**Fig.58**);

**⚠ Before fitting the flush box (C) into the wall it is recommended that in order to prevent water ingress a silicon sealant is used between the wall and the flush box (C) (Fig.59) and around the flush box openings (D) (Fig.59);**

3. Set the flush box (C) into the hole in the wall feeding the connecting cables (E) through the appropriate flush box opening (D), as shown in **Fig.60**;
4. Follow steps 3 and 4, from 'installing a surface mounting door station', to fit the module into the module support frame (H) as shown in **Fig.48, Fig.49** and **Fig.50** (on pages 22 and 23);
5. Next take connecting cables (E) and make the required terminal connections into the terminal block (O) using the screwdriver provided (P) (using the flat blade end), as shown in **Fig.61**;
6. Take the frame's hinges (L) and hook the module support frame (H) to the flush box (C), starting from the left following the guide arrows, as shown in **Fig.62**. Ensure that the frame's hinges (L) (**Fig.62**) fit inside the relevant hinge mounts (M) inside the flush box (C), as shown in **Fig.63**;
7. Next close in the front support frame (H) and then pull it back from the flush box (C) while moving it slightly to the left, following the guide arrows, as shown in **Fig.64**;
8. Next open the module support frame (H) (to allow for easy access to the hinge mounts (M)) and clip the hinge locks (N) to the hinge mounts (M), following the guide arrows, as shown in **Fig.65**;
9. Plug the terminal block (O) (from step 5, **Fig.61**) into the module's terminal block connector (Q), as shown in **Fig.66**. Make any other necessary panel adjustments required (connecting the antenna cable, fitting the SIM card and setting the dip-switches etc.);
10. After the system has been tested and is working correctly, move back the module support frame (H) carefully and then fix it to the flush box (C) using the screwdriver provided (P) (using the torx end) and the torx pin security screws provided (R), as shown in **Fig.67**. **Note: do not over tighten the screws more than is necessary.**



### NOTES

- The screwdriver's blade has two sides, one flat and one torx, to select one of them unplug the blade from the screwdriver body and plug it into the required side.











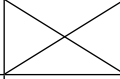
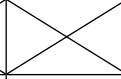
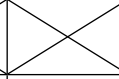
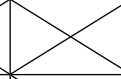
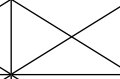

























# Programming via Alpha-Numeric Keypad

## THE ALPHA-NUMERIC KEYPAD

Programming can be carried out using the onboard alpha-numeric keypad. When in programming mode the keypad can be used similar to mobile phone text typing. The following alpha-numeric table can be used when entering a username for example. The table shows the characters and symbols that can be entered into the panel by pressing a specific numeric button one or more times to select the character or symbol desired.

For the Art.4812R with the scroll buttons,  and  are not used. The call button  can also be used to confirm entry.

For the Art.4812 the alpha buttons A-F are not used.

Number of Presses		Button No.								
		1	2	3	4	5	6	7	8	9
1		<space>	.	&	1					
2		A	B	C	2	a	b	c		
3		D	E	F	3	d	e	f		
4		G	H	I	4	g	h	i		
5		J	K	L	5	j	k	l		
6		M	N	O	6	m	n	o		
7		P	Q	R	S	7	p	q	r	s
8		T	U	V	8	t	u	v		
9		W	X	Y	Z	9	w	x	y	z
0		+	-	*	/	0				
 		unused buttons								
     										
 		confirm entry								
		delete previous character/symbol and cancel								

### Example:

When entering an apartment name, to type the name "VIDEX" the following buttons can be pressed on the keypad:

Press button "8" ,  , 3 times = "V";

Press button "4" ,  , 3 times = "I";

Press button "3" ,  , once = "D";

Press button "3" ,  , twice = "E";

Press button "9" ,  , twice = "X";

# Programming Flowcharts

## ACCESSING MAIN PROGRAMMING MENU

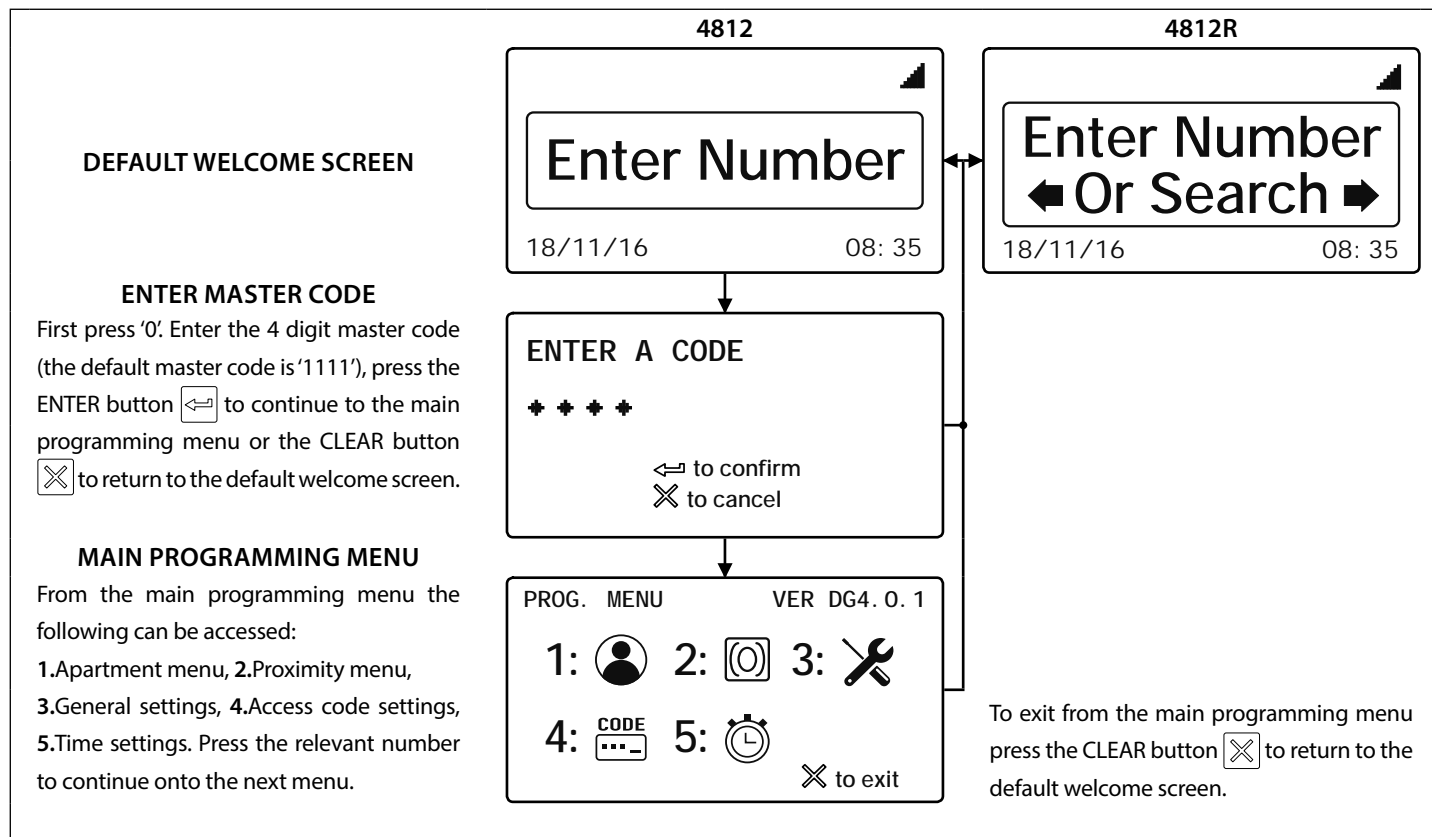

## ACCESSING ADMIN MENU

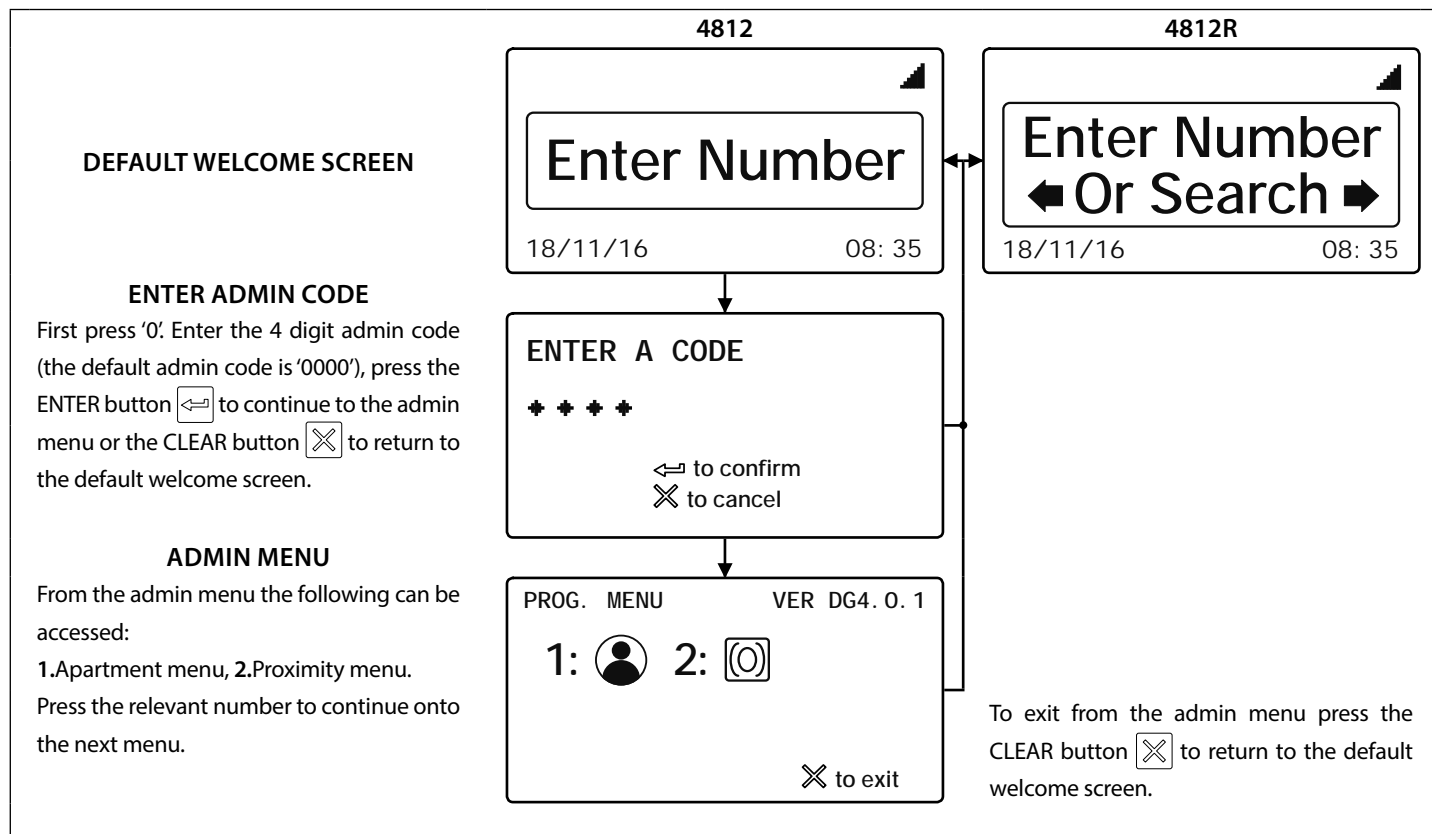

# Programming Flowcharts

## 1. APARTMENT MENU

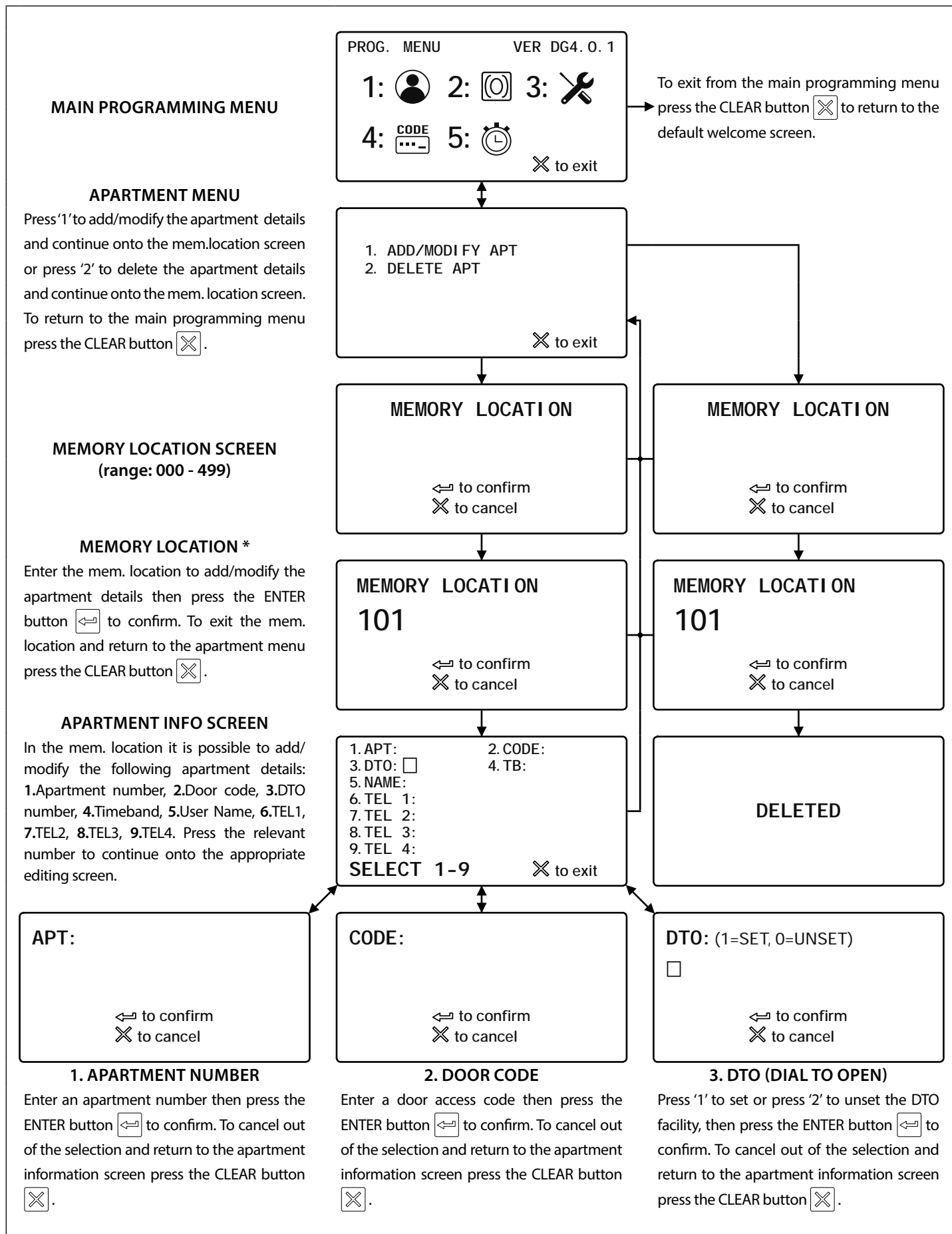

# Programming Flowcharts

## 1. APARTMENT MENU (CONTINUED)

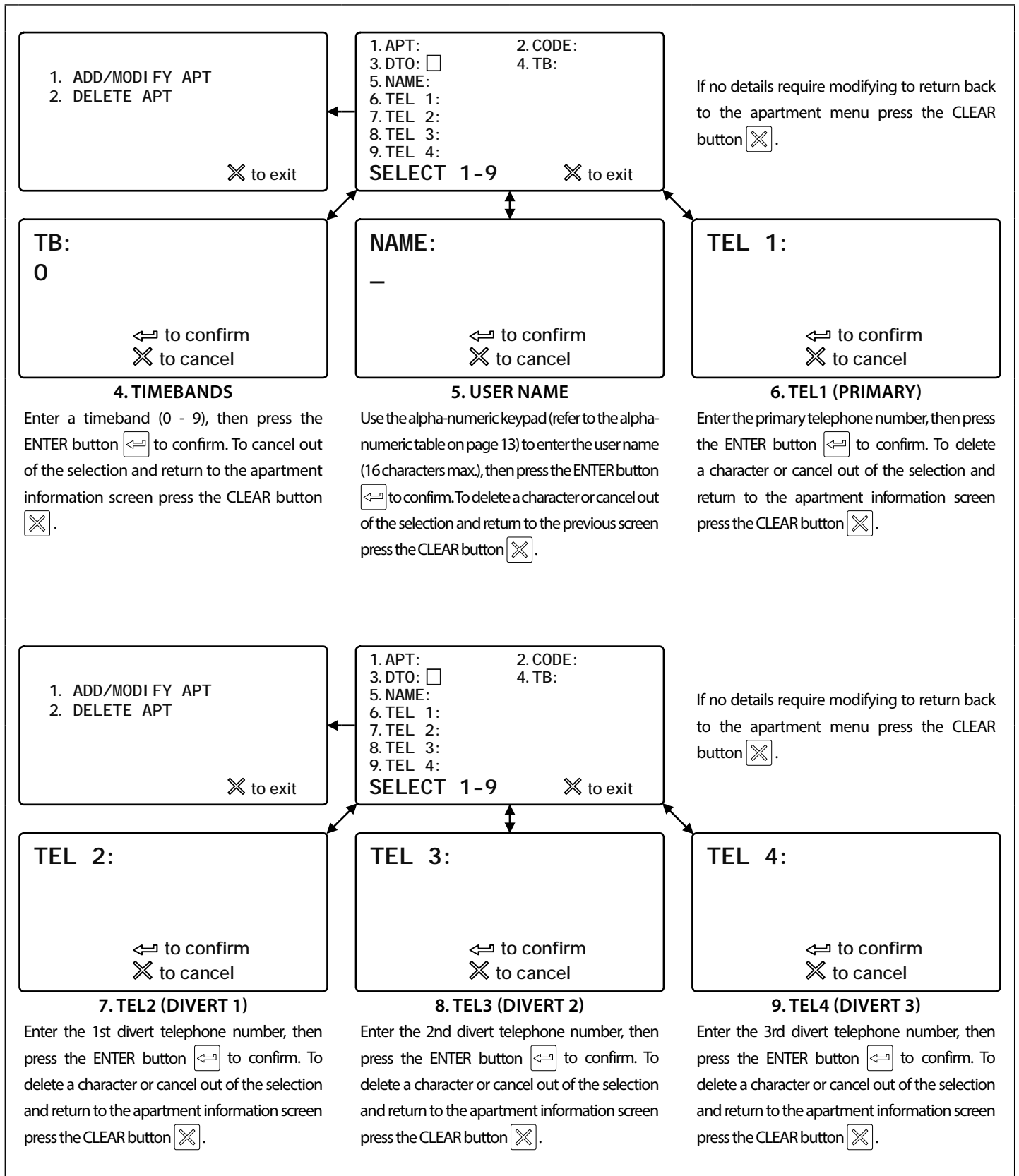

\* **IMPORTANT NOTE:** Programming an access code into memory location '000' (via the Apartment Menu) will operate the auxiliary output AO for the programmed AO time (A1T). When a user enters this code via the keypad the digital GSM will show 'OK' on the display to confirm the auxiliary output AO has been activated. Please also note that activating the auxiliary output in this way is only possible when the auxiliary output mode A1M has been set to mode 001.

# Programming Flowcharts

## 2. PROXIMITY MENU

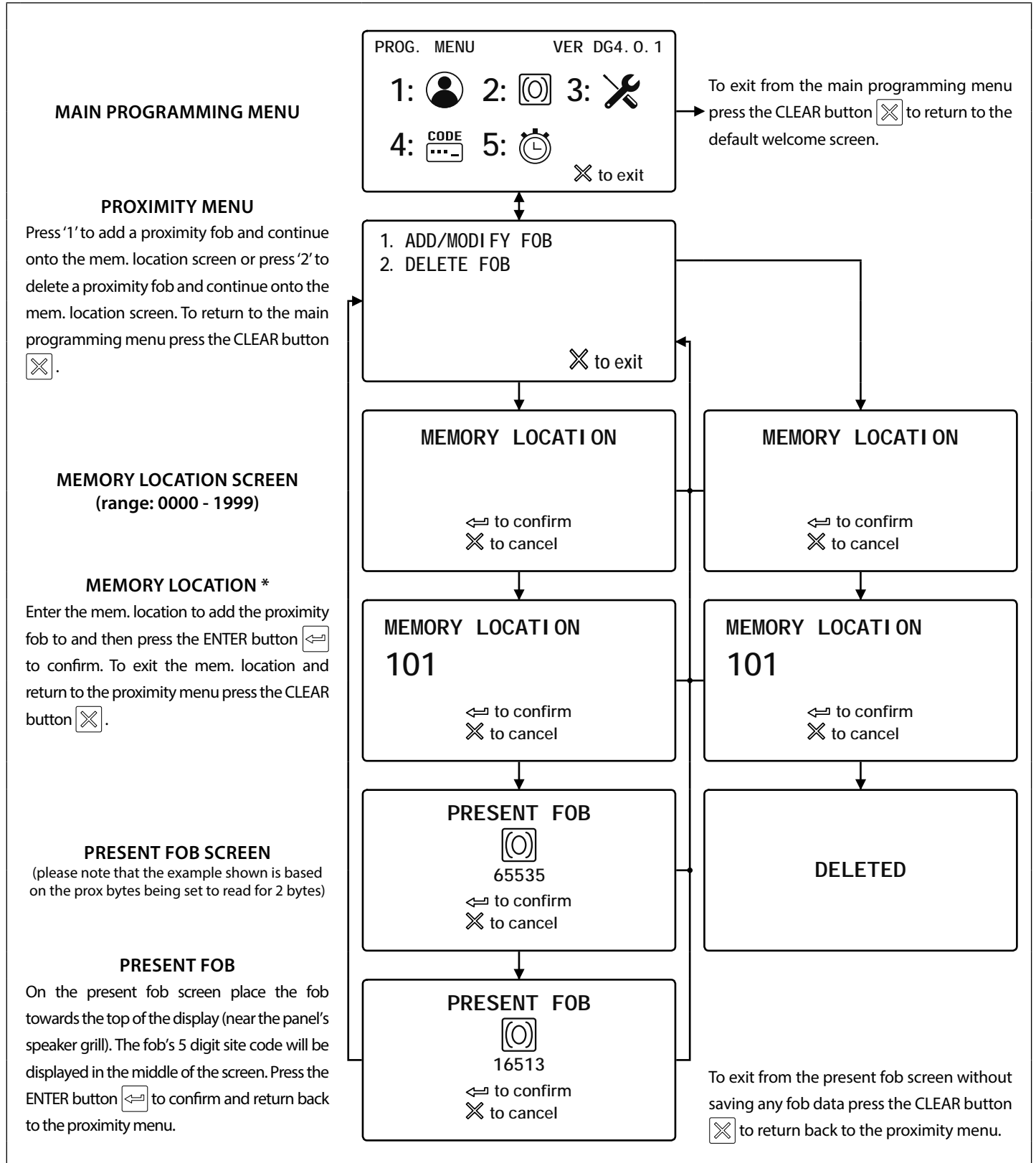

\* **IMPORTANT NOTE:** Programming a proximity fob/card into memory location '0000' (via the Proximity Menu) will operate the auxiliary output AO for the programmed AO time (A1T). When a user presents the programmed fob/card to the onboard reader the digital GSM will show 'OK' on the display to confirm the auxiliary output AO has been activated. Please also note that activating the auxiliary output in this way is only possible when the auxiliary output mode A1M has been set to mode 001.

# Programming Flowcharts

## 3. GENERAL SETTINGS

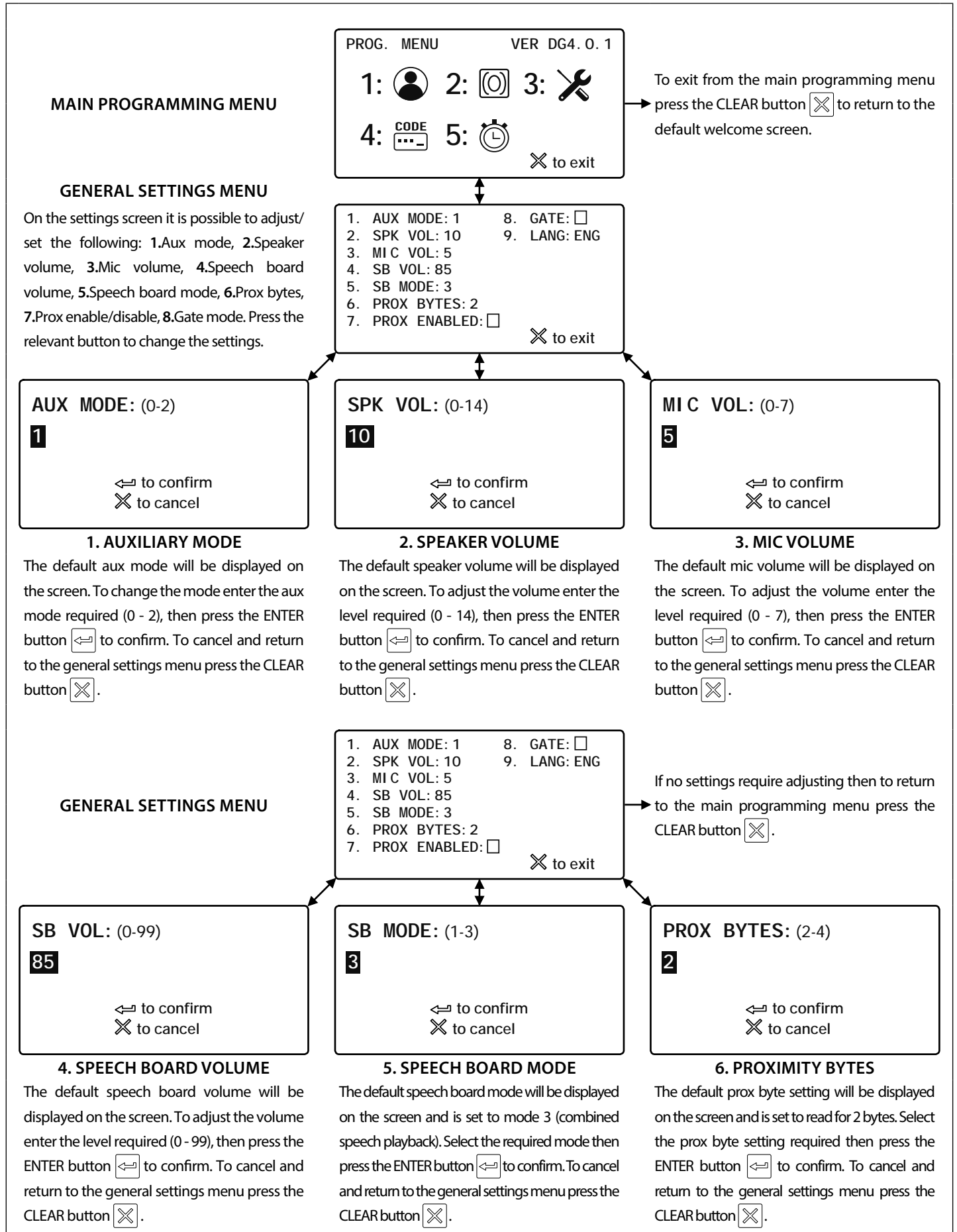

# Programming Flowcharts

## 3. GENERAL SETTINGS ✕ (CONTINUED)

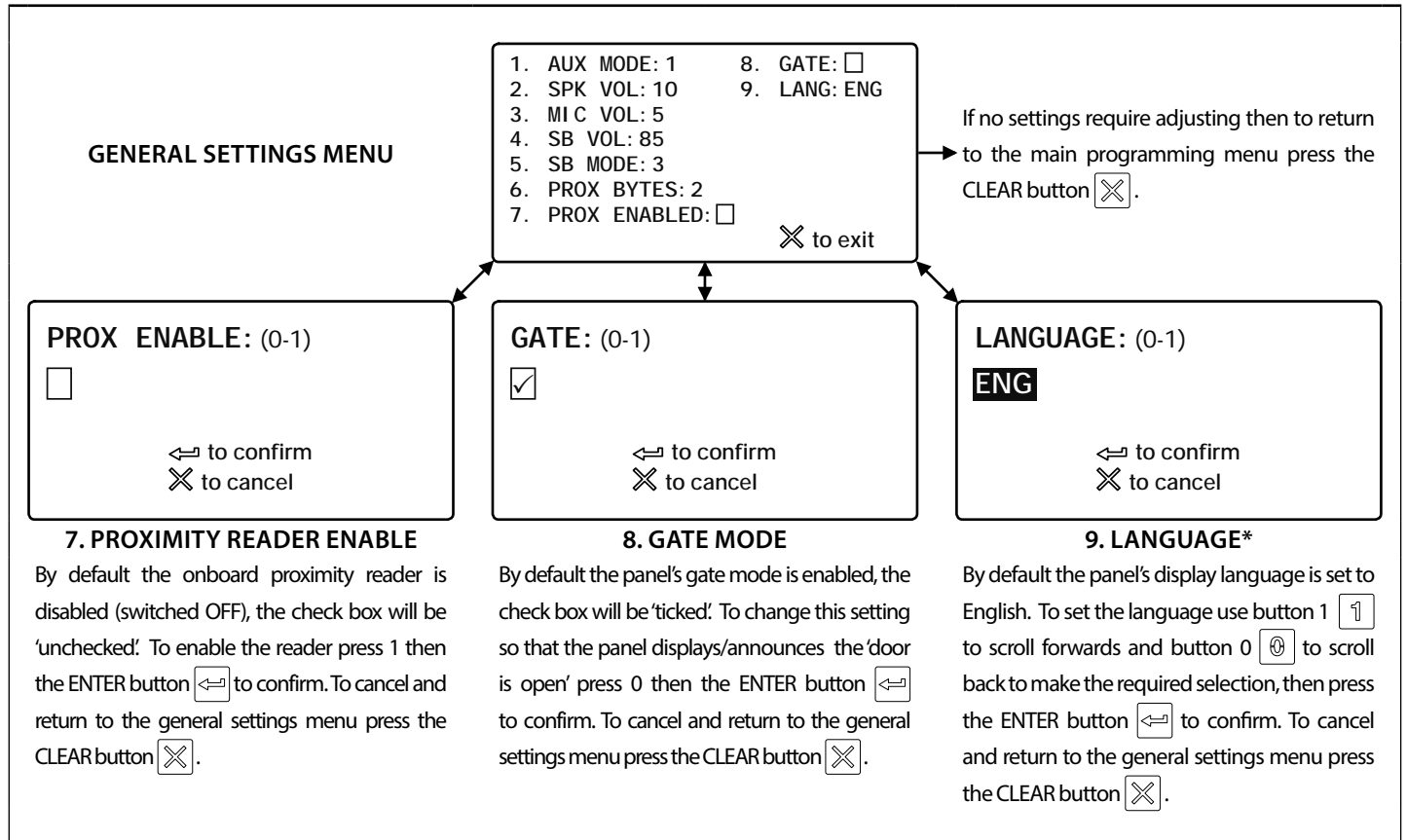

**\*IMPORTANT NOTE:** When setting the language only the panels on screen display messages (e.g. calling apartment 'nnn', enter number, door open etc.) will be shown in the chosen language. The digital GSM's on screen programming menus will still be displayed in English. Fig.68 shows an example of what the panel would display when calling an apartment if the language has been set to ITA (italian).

The list of supported languages (in scrolling order) : **ENG** (English); **ITA** (Italian); **SPA** (Spanish); **POR** (Portuguese); **FRA** (French); **GER** (German); **CZE** (Czech); **CRO** (Croatian); **DAT** (Dutch); **POL** (Polish); **SLO** (Slovenian); **DAN** (Danish); **NOR** (Norwegian) and **HEB** (Hebrew).

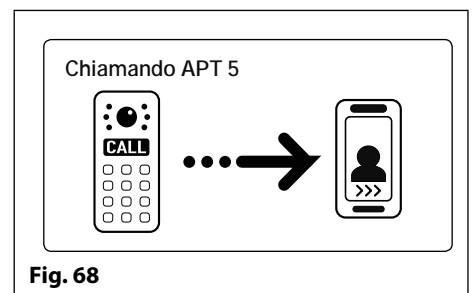



# Programming Flowcharts

## 4. CODE MENU CODE MENU

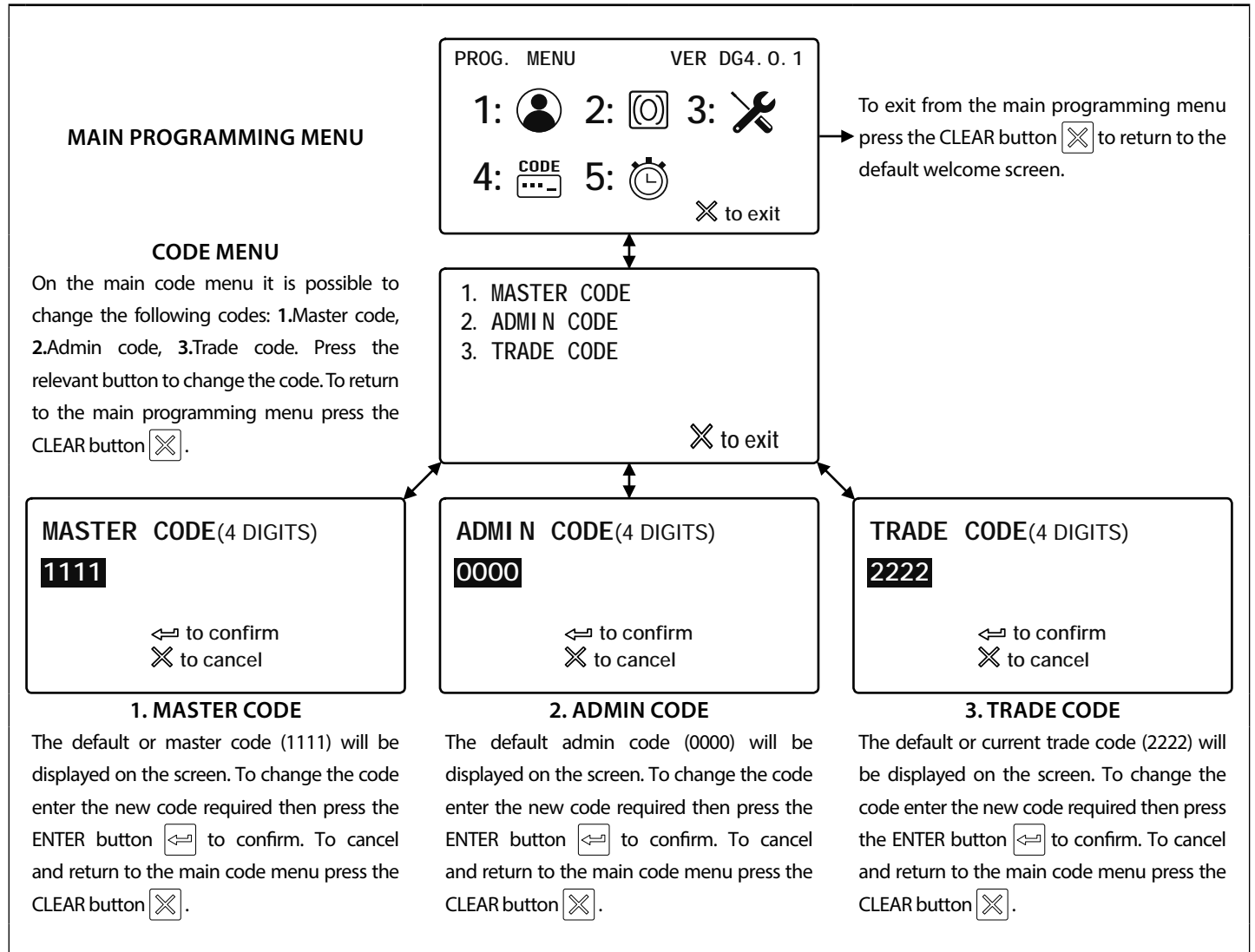

# Programming Flowcharts

## 5. TIME SETTINGS MENU

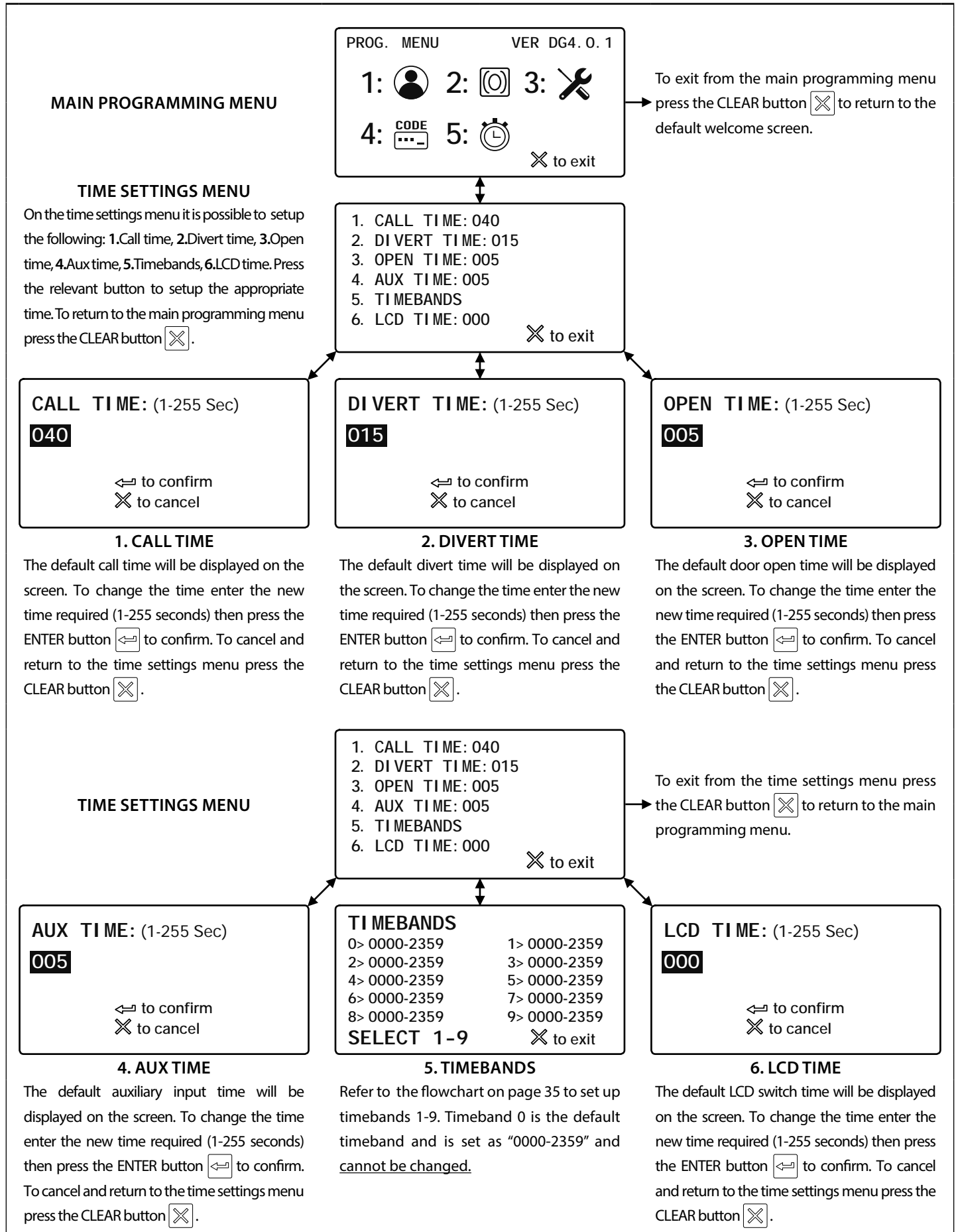

# Programming Flowcharts

## 5. TIME SETTINGS MENU (CONTINUED)

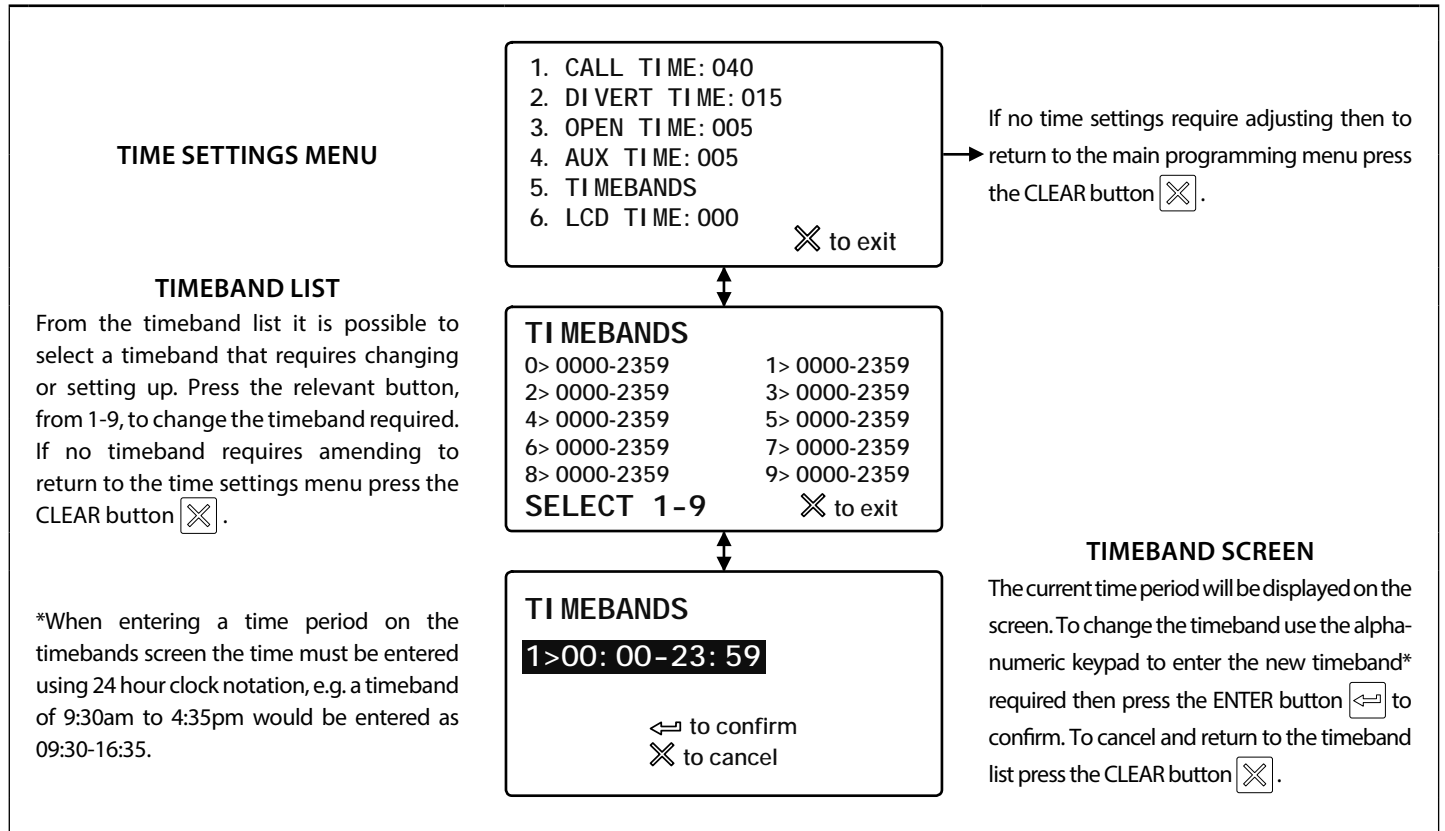

# Programming Screens

## MAIN PROGRAMMING MENU

From the main programming menu (refer to **Fig.69**) it is possible to access the following sub menus:

1. Apartment menu
2. Proximity menu
3. General settings menu
4. Code menu
5. Time settings menu

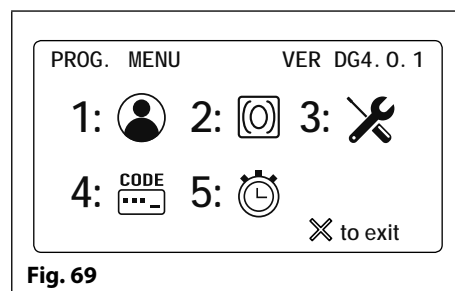
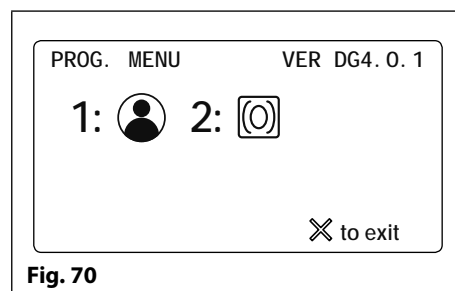

**Fig. 69**

## ADMIN MENU

From the admin menu (refer to **Fig.70**) it is possible to only access the following two sub menus:

1. Apartment menu
2. Proximity menu



**Fig. 70**

Please note that the current firmware version of the digital GSM is shown in the top right corner of both the main programming and admin menus.

### 1.1 APARTMENT MENU (ADD/MODIFY APT)

From the apartment menu (refer to **Fig.71**) it is possible to edit the following details:

1. Add or modify apartment details
2. Delete apartment details

Selecting option 1 from the apartment menu will first access the memory location screen and then from there the apartment information screen (refer to **Fig.72**).

The apartment information screen has 9 available options that allows the following information to be entered, enabled and/or assigned:

1. Apartment number (APT)
2. Door/gate access code (CODE)
3. Dial to open number enable (DTO)
4. Timeband assignment (TB)
5. Username (NAME)
6. Primary telephone number (TEL1)
7. First divert number (TEL2)
8. Second divert number (TEL3)
9. Third divert (TEL4)

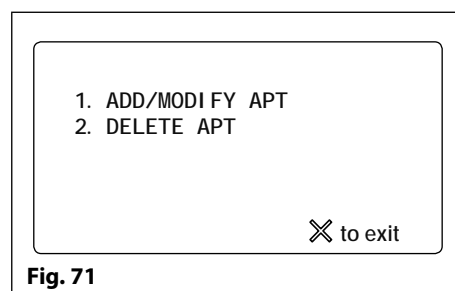

**Fig. 71**

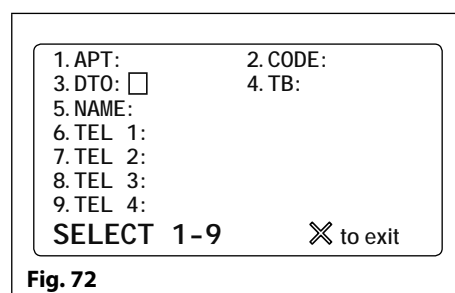

**Fig. 72**

#### 1.1.1 APARTMENT NUMBER (APT)

The apartment number can be entered on the apartment screen (refer to **Fig.73**) and can be made up of a maximum of 6 digits or letters (A - F only) or a combination of both e.g. apartment 100A, 100B etc.

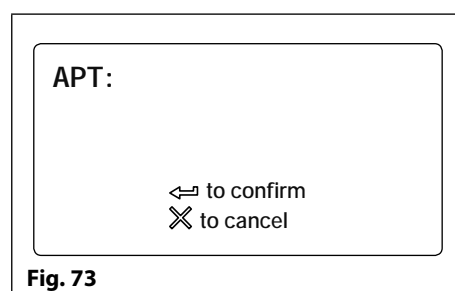

**Fig. 73**

## Programming Screens

### 1.1.2 DOOR/GATE ACCESS CODE

The door/gate access code can be entered on the code screen (refer to **Fig.74**) and can be made up of a maximum of 6 digits (no letters).

**IMPORTANT NOTE:** Remember if programming an access code into memory location '000' it will only operate the auxiliary output AO for the programmed AO time (A1T) and not the onboard relay. Please also note that activating the auxiliary output in this way is only possible when the auxiliary output mode A1M has been set to mode 001.

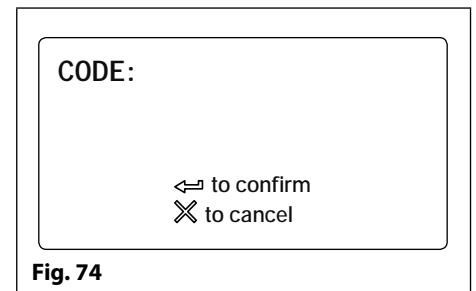

**Fig. 74**

### 1.1.3 DIAL TO OPEN NUMBER (DTO)

The dial to open (DTO) number can be enabled on the DTO screen. Enter "1" to enable (set, refer to **Fig.75**) the dial to open number or "0" to disable (unset, refer to **Fig.76**) the dial to open number. When set the primary and 3 divert numbers are automatically set as dial to open numbers.

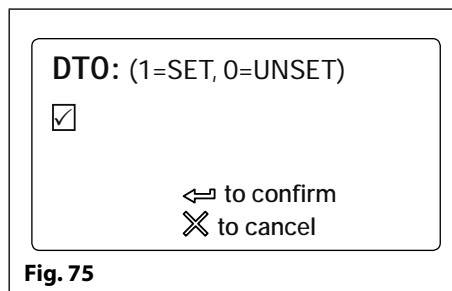

**Fig. 75**

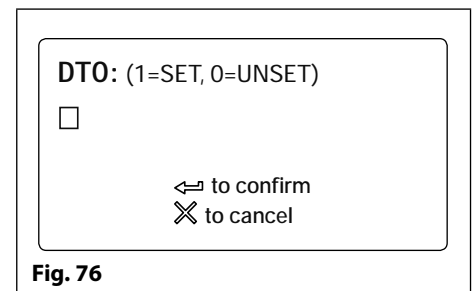

**Fig. 76**

### 1.1.4 TIMEBAND (TB)

A timeband can be assigned, to an apartment or apartments for when they can be called, on the timeband assignment screen (refer to **Fig.77**). The default timeband setting is "0" (0000 - 2359), calls to the apartments are enabled all the time. Timeband "0" cannot be changed, timebands 1 - 9 are programmable and can be set on the timeband set up screen (refer to **Fig.109** and **Fig.110** on page 43).

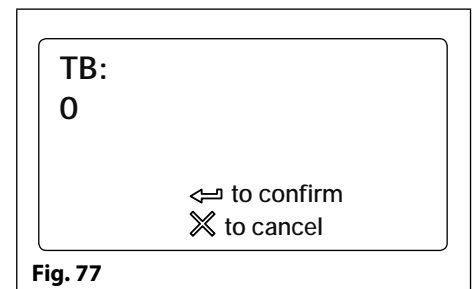

**Fig. 77**

### 1.1.4 USERNAME (NAME)

A username can be entered for an apartment on the username screen (refer to **Fig.78**). A maximum of 16 characters can be entered via the alpha-numeric keypad following the keypad programming table on page 26.

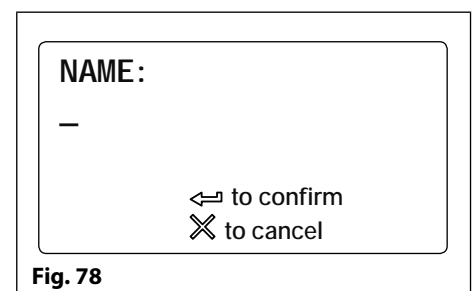

**Fig. 78**

### 1.1.5 TELEPHONE NUMBERS (PRIMARY NUMBER AND 3 DIVERT NUMBERS)

Options 6 (TEL1), 7 (TEL2), 8 (TEL3) and 9 (TEL4) on the apartment information screen is where the primary telephone number and the 3 divert numbers can be programmed respectively (refer to **Fig.79**, **Fig.80**, **Fig.81** and **Fig.82**) and can be a maximum of 30 digits. If a landline number is being programmed then the full regional dialing code must be included as part of the telephone number.

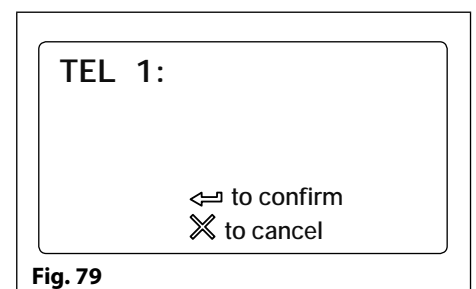

**Fig. 79**

## Programming Screens

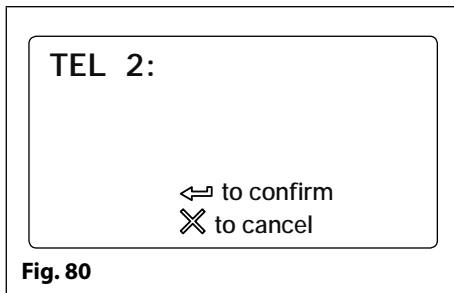

Fig. 80

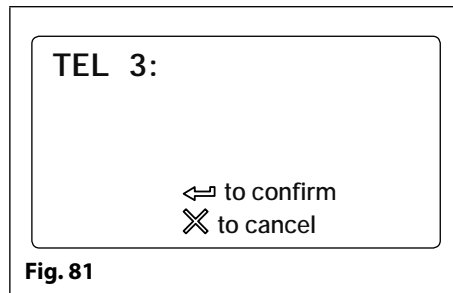

Fig. 81

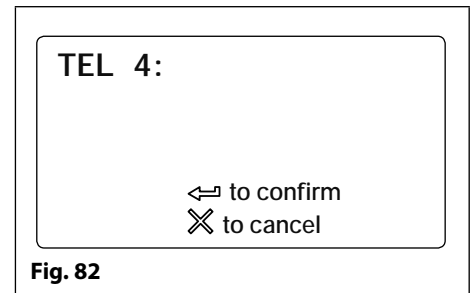

Fig. 82

### 1.2 APARTMENT MENU (DELETE APT)

Selecting option 2 from the apartment menu will access the memory location screen (refer to **Fig.83**). Enter the memory location of the apartment to delete and press the ENTER button. The deleted screen will appear (refer to **Fig.84**) to confirm the apartment details have been deleted and then return back to the apartment menu.

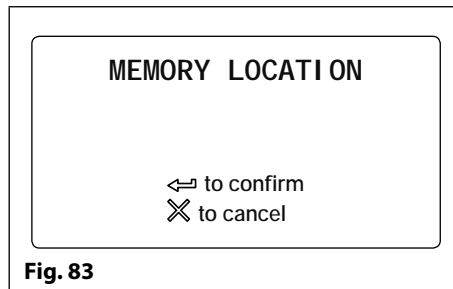

Fig. 83

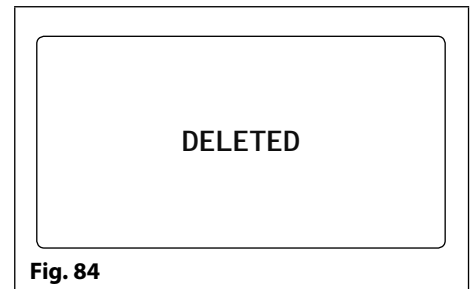

Fig. 84

**IMPORTANT NOTE:** When deleting a memory location all the user's information is deleted from the digital GSM intercom (telephone numbers, username, apartment number etc.).

### 2.1 PROXIMITY MENU (ADD/MODIFY FOB)

From the proximity menu (refer to **Fig.85**) it is possible to edit the following details:

1. Add or modify fob details
2. Delete fob details

Selecting option 1 from the proximity menu will first access the memory location screen (refer to **Fig.83**) and then from there the default present fob screen. The default present fob screen that the panel shows will depend on which prox byte setting the panel has been set to (refer to **Fig.86** for 2 bytes, **Fig.87** for 3 bytes and **Fig.88** for 4 bytes). The prox byte setting can be changed on the general settings screen, option 6. Also see prox byte notes on page 40.

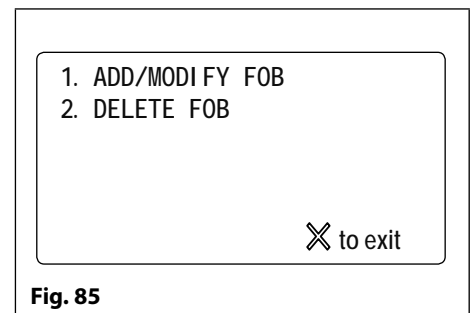

Fig. 85

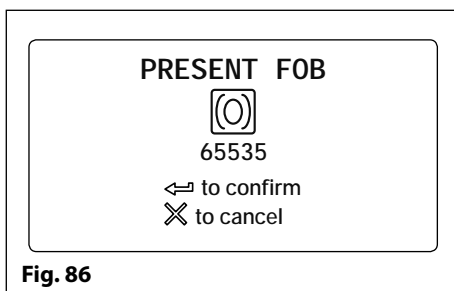

Fig. 86

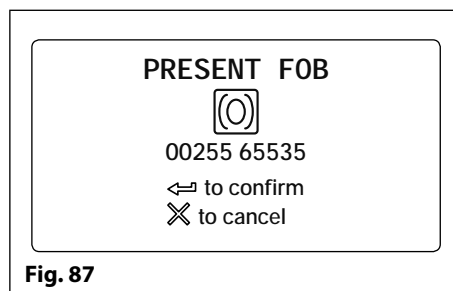

Fig. 87

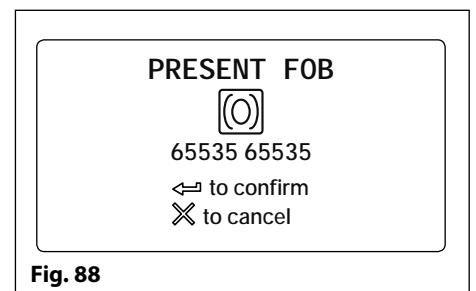

Fig. 88

When the present fob screen appears place the proximity fob towards the display, in front of the fob symbol, as shown in **Fig.89**. The display will show the fob number just below the fob symbol once it has read the fob. To confirm and save the details press the ENTER button and the screen will revert back to the proximity menu (see **Fig.85**).

**IMPORTANT NOTE:** Remember when programming a proximity fob/card into memory location '0000' it will only operate the auxiliary output AO for the programmed AO time (A1T) and not the onboard relay. Please also note that activating the auxiliary output in this way is only possible when the auxiliary output mode A1M has been set to mode 001.

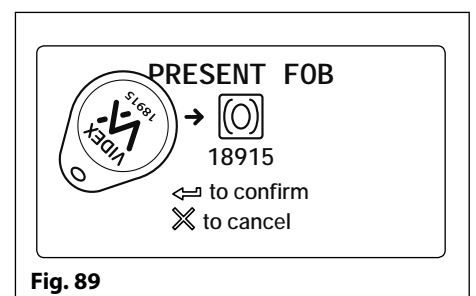

Fig. 89

### 2.2 PROXIMITY MENU (DELETE/FOB)

Selecting option 2 from the proximity menu will access the memory location screen (refer to **Fig.83**). Enter the memory location of the fob to delete and press the ENTER button. The deleted screen will appear (refer to **Fig.84**) to confirm the apartment details have been deleted and then revert back to the proximity menu.

## Programming Screens

### 3 GENERAL SETTINGS MENU ✕

From the general settings menu (refer to **Fig.90**) it is possible to adjust the following panel settings:

1. Auxiliary mode
2. Speaker volume
3. Microphone volume
4. Speechboard volume
5. Speechboard mode
6. Proximity bytes
7. Proximity enable
8. Gate mode

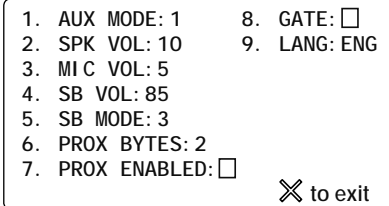

**Fig. 90**

After each menu option the current mode or setting for the panel is shown (on initial install the default modes and settings will be displayed as shown in **Fig.90**). Press the relevant button on the panel to select the menu option that requires adjustment.

#### 3.1 AUXILIARY MODE (AUX MODE)

Selecting option 1 from the general settings menu will access the auxiliary mode screen (see **Fig.91**). From this screen the mode of the auxiliary output AI can be set. The current setting will be highlighted on the second line of the screen (see **Fig.91**). The default setting is set to mode 1. To set the AI mode select one of the following:

0. **On during a call** - the AI output will activate when a call begins and deactivate when the call ends.
1. **On when triggered (default mode)** - the AI output will only activate when button 6 on the telephone is pressed during a call.
2. **Call activated (timed)** - the AI output will activate when a call begins and deactivate when the auxiliary output time ends.



**Fig. 91**

To confirm and save the setting press the ENTER button and the screen will revert back to the general settings menu (refer to **Fig.90**).

#### 3.2 SPEAKER VOLUME (SPK VOL)

Selecting option 2 from the general settings menu will access the speaker volume control screen (refer to **Fig.92**). On this screen the speaker volume of the GSM panel can be adjusted. The current setting will be highlighted on the second line of the screen (see **Fig.92**). The default speaker volume level is set to 10 and can be adjusted between 0 (low) up to 14 (high). Enter the volume level required then to confirm and save the setting press the ENTER button and the screen will revert back to the general settings menu (refer to **Fig.90**).



**Fig. 92**

#### 3.3 MICROPHONE VOLUME (MIC VOL)

Selecting option 3 from the general settings menu will access the microphone volume control screen (refer to **Fig.93**). On this screen the microphone volume of the GSM panel can be adjusted. The current setting will be highlighted on the second line of the screen (see **Fig.93**). The default microphone volume level is set to 5 and can be adjusted between 0 (low) up to 7 (high). Enter the volume level required then to confirm and save the setting press the ENTER button and the screen will revert back to the general settings menu (refer to **Fig.90**).

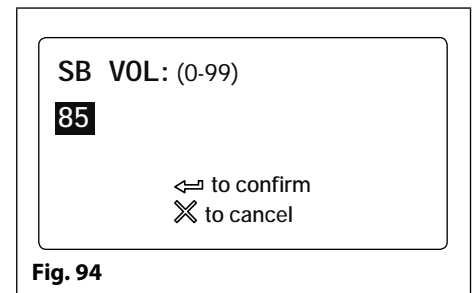

**Fig. 93**

## Programming Screens

### 3.4 SPEECHBOARD VOLUME (SB VOL)

Selecting option 4 from the general settings menu will access the speechboard volume control screen (refer to **Fig.94**). On this screen the speechboard volume of the GSM panel can be adjusted. The current setting will be highlighted on the second line of the screen (see **Fig.94**). The default speechboard volume level is set to 85 and can be adjusted between 0 (low) up to 99 (high). Enter the volume level required then to confirm and save the setting press the ENTER button and the screen will revert back to the general settings menu (refer to **Fig.90**).



**Fig. 94**

### 3.5 SPEECHBOARD MODE (SB MODE)

Selecting option 5 from the general settings menu will access the speechboard mode screen (refer to **Fig.95**). From this screen the speechboard mode can be set. The current setting will be highlighted on the second line of the screen (see **Fig.95**). Three modes are available: mode 1, 2 or 3 (see mode options below). The default setting is set to mode 3. To set the speechboard mode select one of the following:

**MODE 1 - Speechboard disabled** - the speechboard will be switched OFF (no speech annunciation will be heard through the panel's speaker).

**MODE 2 - Individual speech playback** - the speechboard will be switched ON. When an apartment is called the panel's speechboard will playback the individual numbers that make up an apartment number e.g. if calling apartment 25 the speech will playback "calling two five".

**MODE 3 - Combined speech playback (default mode)** - the speechboard will be switched ON. When an apartment is called the panel's speechboard will playback the combined numbers that make up an apartment number e.g. if calling apartment 36 the speech will playback "calling thirty six".

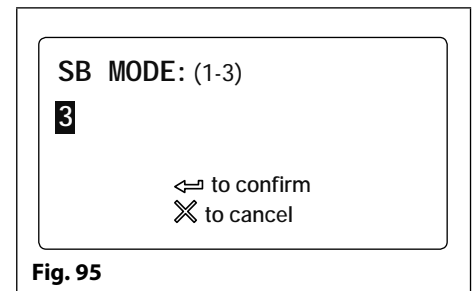

**Fig. 95**

To confirm and save the setting press the ENTER button and the screen will revert back to the general settings menu (refer to **Fig.90**).

### 3.6 PROX BYTE SETTING (PROX BYTES)

Selecting option 6 from the general settings menu will access the proximity byte setting screen (refer to **Fig.96**). From this screen the number of proximity bytes that the onboard reader checks can be set. The current setting will be highlighted on the second line of the screen (see **Fig.96**). There are three byte settings that the panel's reader can be set to check for: 2, 3 or 4 bytes (see byte settings below). The default setting is set to check for 2 bytes. To set the number of bytes select one of the following:

**2 Bytes (default setting)** - set the panel to check for 2 bytes if the proximity fob/card has no site code and only a 5 digit user code (955/T fobs or 955/C cards).

**3 Bytes** - set the panel to check for 3 bytes if the proximity fob/card has a 3 digit site code and a 5 digit user code (PBX1E fobs or PBX2 cards).

**4 Bytes** - set the panel to check for 4 bytes for proximity fobs/cards that have a longer site code and a 5 digit user code.

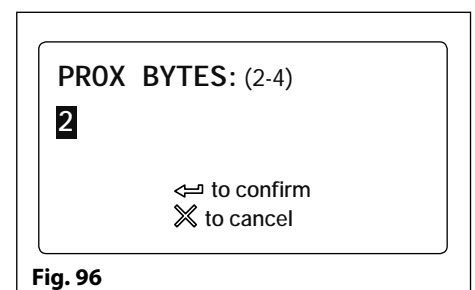
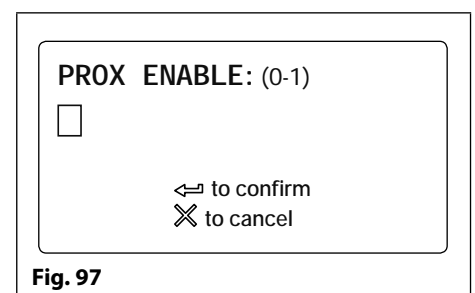

**Fig. 96**

To confirm and save the setting press the ENTER button and the screen will revert back to the general settings menu (refer to **Fig.90**).

### 3.7 PROXIMITY READER ENABLE/DISABLE (PROX ENABLE)

Selecting option 7 from the general settings menu will access the proximity reader enable screen (refer to **Fig.97**). On this screen the proximity reader on the GSM panel can be switched ON and OFF. The current setting will be indicated on the second line of the screen with or without a tick in the check box (see **Fig.97**). By default the onboard reader will be switched OFF. Enter a "0" (reader switched OFF) to disable the reader or a "1" (reader switched ON) to enable the reader. To confirm and save the setting press the ENTER button and the screen will revert back to the general settings menu (refer to **Fig.90**).



**Fig. 97**



## Programming Screens

### 3.8 GATE MODE (GATE)

Selecting option 8 from the general settings menu will access the gate mode screen (refer to **Fig.98**). On this screen the gate mode of the panel can be set. The current setting will be indicated on the second line of the screen with or without a tick in the check box (see **Fig.98**). By default the gate mode is set with the check box ticked. To set the gate mode enter one of the following:

- 0 -  When set in this mode and the panel's onboard relay is activated the display will show that the door is open (refer to **Fig.109** on pages 60 - 61). The speech annunciation (if the speechboard is switched ON) will announce "the door is open".
- 1 -  When set in this mode and the panel's onboard relay is activated the display will show that the gate is open (refer to **Fig.110** on pages 60 - 61). The speech annunciation (if the speechboard is switched ON) will announce "the gate is open".

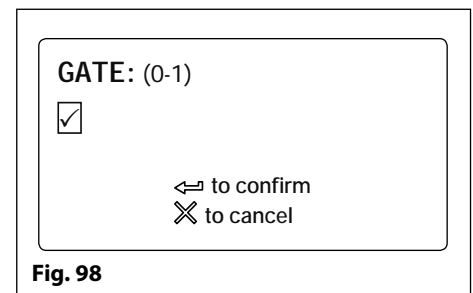



**Fig. 98**

To confirm and save the setting press the ENTER button and the screen will revert back to the general settings menu (refer to **Fig.90**).

### 3.9 LANGUAGE (LANG)

Selecting option 9 from the general settings menu will access the language selection screen (refer to **Fig.99**). On this screen the desired language can be selected. The current language setting will be highlighted on the second line of the screen (see **Fig.99**). By default English is already set.

It should be noted that only the panels on screen display messages (e.g. calling apartment 'nnn', enter number, door open etc.) will be shown in the chosen language. The digital GSM's on screen programming menus will still be displayed in English.

To set the language use button 1  to scroll forwards and button 0  to scroll back to make the required selection, then press the ENTER button  to confirm and the screen will revert back to the general settings menu (refer to **Fig.90**).

The list of supported languages (in scrolling order) : **ENG** (English); **ITA** (Italian); **SPA** (Spanish); **POR** (Portuguese); **FRA** (French); **GER** (German); **CZE** (Czech); **CRO** (Croatian); **DAT** (Dutch); **POL** (Polish); **SLO** (Slovenian); **DAN** (Danish); **NOR** (Norwegian) and **HEB** (Hebrew).

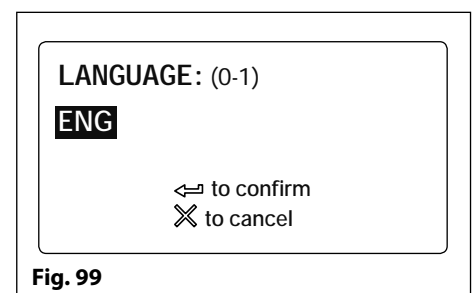

**Fig. 99**

### 4 CODE MENU

From the code menu (refer to **Fig.100**) it is possible to edit the following access codes:

1. Master code (by default is set to "1111")
2. Admin code (by default is set to "0000")
3. Trade code (by default is set to "2222")

Press the relevant button (1, 2 or 3) to change the required access code.

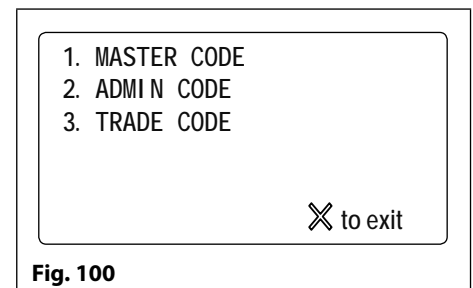

**Fig. 100**

### 4.1 MASTER CODE

Selecting option 1 from the code menu will access the master code screen (refer to **Fig.101**). On this screen the master code of the GSM panel can be changed. The current setting will be highlighted on the second line of the screen (see **Fig.101**). By default the master code is set to "1111" and can be changed to any 4 digit number, but must be kept as a 4 digit number. Enter the new code required then to confirm and save the setting press the ENTER button and the screen will revert back to the general settings menu (refer to **Fig.90**).

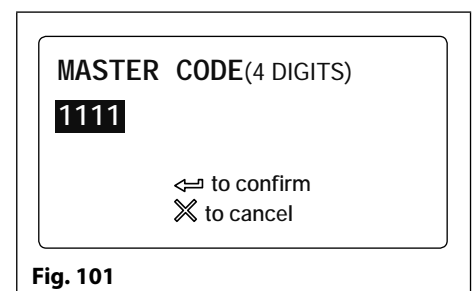
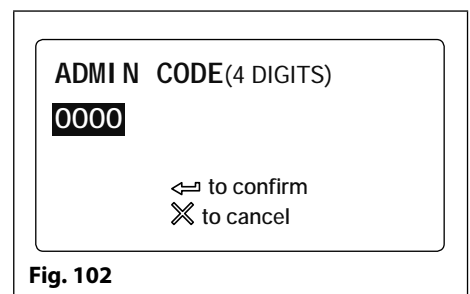

**Fig. 101**

## Programming Screens

### 4.2 ADMIN CODE

Selecting option 2 from the code menu will access the admin code screen (refer to **Fig.102**). On this screen the admin code of the GSM panel can be changed. The current setting will be highlighted on the second line of the screen (see **Fig.102**). By default the admin code is set to "0000" and can be changed to any 4 digit number, but must be kept as a 4 digit number. Enter the new code required then to confirm and save the setting press the ENTER button and the screen will revert back to the general settings menu (refer to **Fig.90**).

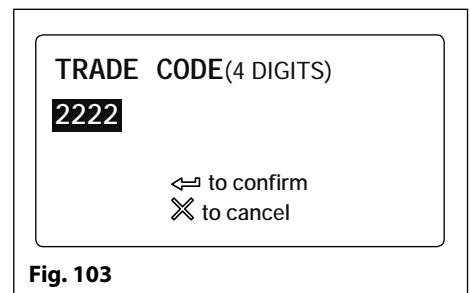

**Fig. 102**

### 4.3 TRADE CODE

Selecting option 3 from the code menu will access the trade code screen (refer to **Fig.103**). On this screen the trade code of the GSM panel can be changed. The current setting will be highlighted on the second line of the screen (see **Fig.103**). By default the trade code is set to "2222" and can be changed to any 4 digit number, but must be kept as a 4 digit number. Enter the new code required then to confirm and save the setting press the ENTER button and the screen will revert back to the general settings menu (refer to **Fig.90**).

**IMPORTANT NOTE:** The trade code will only operate when the TRD connection is shorted to 0V.

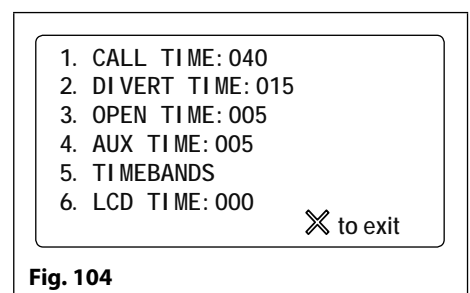

**Fig. 103**

### 5 TIME SETTINGS MENU

From the time settings menu (refer to **Fig.104**) it is possible to adjust the following panel settings:

1. Call time
2. Divert time
3. Open time
4. Aux time
5. Timebands
6. LCD time

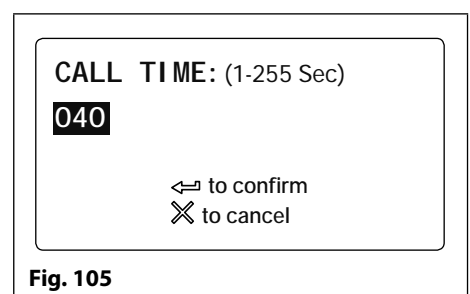

**Fig. 104**

After each menu option the current mode or setting for the panel is shown (on initial install the default modes and settings will be displayed as shown in **Fig.104**). Press the relevant button on the panel to select the menu option that requires adjustment.

### 5.1 CALL TIME

Selecting option 1 from the time settings menu will access the call time screen (refer to **Fig.105**). On this screen the call time of the GSM panel can be adjusted. The current setting will be highlighted on the second line of the screen (see **Fig.105**). The default call time is set to 40 seconds and can be adjusted from 1 second up to 255 seconds. Enter the call time required then to confirm and save the setting press the ENTER button and the screen will revert back to the time settings menu (refer to **Fig.104**).



**Fig. 105**

### 5.2 DIVERT TIME

Selecting option 2 from the time settings menu will access the divert time screen (refer to **Fig.106**). On this screen the divert time of the GSM panel can be adjusted. The current setting will be highlighted on the second line of the screen (see **Fig.106**). The default divert time is set to 15 seconds and can be adjusted from 1 second up to 255 seconds. Enter the divert time required then to confirm and save the setting press the ENTER button and the screen will revert back to the time settings menu (refer to **Fig.104**).

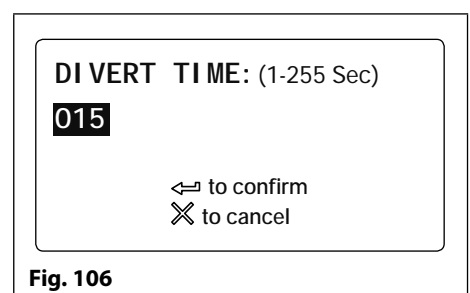

**Fig. 106**

## Programming Screens

### 5.3 OPEN TIME

Selecting option 3 from the time settings menu will access the open time screen (refer to **Fig.107**). On this screen the door/gate open time of the GSM panel can be adjusted. The current setting will be highlighted on the second line of the screen (see **Fig.107**). The default divert time is set to 5 seconds and can be adjusted from 1 second up to 255 seconds. For latching mode set the relay time to 000 seconds. Enter the door/gate open time required then to confirm and save the setting press the ENTER button and the screen will revert back to the time settings menu (refer to **Fig.104**).

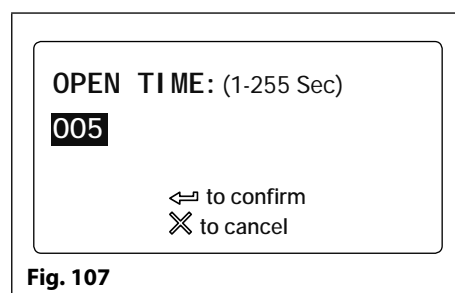

Fig. 107

### 5.4 AUX TIME

Selecting option 4 from the time settings menu will access the aux time screen (refer to **Fig.108**). On this screen the time that the auxiliary input stays active for can be adjusted. The current setting will be highlighted on the second line of the screen (see **Fig.108**). The default auxiliary time is set to 5 seconds and can be adjusted from 1 second up to 255 seconds. For latching mode set the relay time to 000 seconds. Enter the aux time required then to confirm and save the setting press the ENTER button and the screen will revert back to the time settings menu (refer to **Fig.104**).

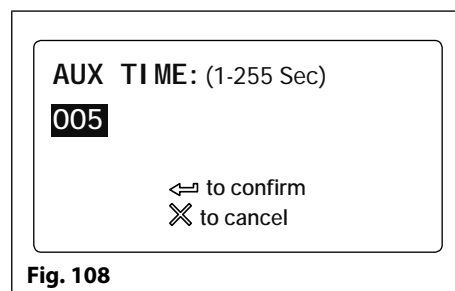

Fig. 108

### 5.5 TIMEBANDS

Selecting option 5 from the time settings menu will access the 1st timeband screen (refer to **Fig.109**). On this screen the timebands can be selected and then programmed on the next timeband screen. The GSM intercom has 9 programmable timebands (1 - 9). Timeband "0" is the default timeband and is permanently set from 0000 - 2359 and cannot be adjusted.

To enter a time period for one of the programmable timebands press the relevant button to make the selection. The display will access the 2nd timeband screen and the current time period will be highlighted on the second line of the display (refer to **Fig.110**).

Enter the time period required (using 24 hour clock notation, e.g. 4:35pm would be entered as 16:35). To confirm and save the setting press the ENTER button and the screen will revert back to the timebands list (refer to **Fig.109**).

It should be noted that the timebands set up on these screens can be assigned to a specific apartment or apartments (refer to **Fig.77** and notes on page 37).

The time settings entered within a timeband is the period of time that an apartment is available for a call. For any period of time outside of the programmed timeband and any call from the GSM intercom to the apartment is disabled, e.g. if timeband 1 is set between 10:00 to 14:35 and has been assigned to apartment 1, a call from the GSM intercom to apartment 1 during this time period will call through ok. Any attempt to call apartment 1 outside of these times then the GSM intercom will not call the apartment. During such an event the GSM intercom's speechboard (if switched ON) will announce "the phone is switched off, please try later". The display will indicate this as shown in **Fig.111**.

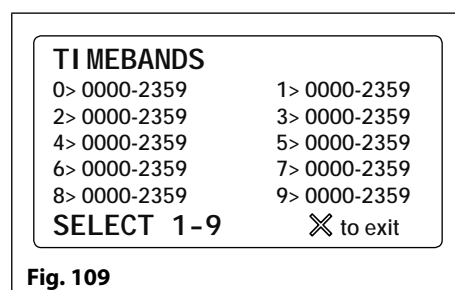

Fig. 109

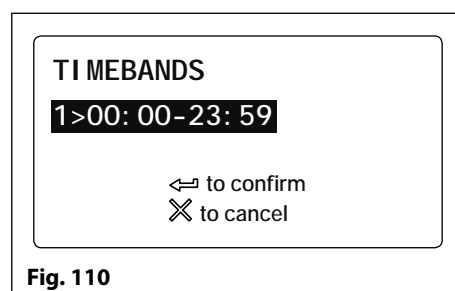

Fig. 110

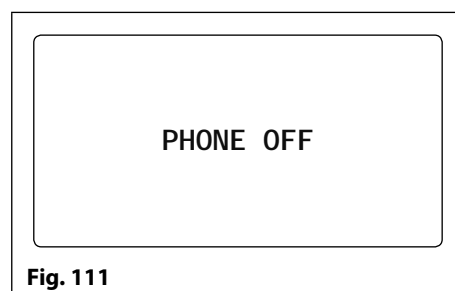

Fig. 111

## Programming Screens

### 5.6 LCD TIME

Selecting option 6 from the time settings menu will access the LCD time screen (refer to **Fig.112**). On this screen the switch time of the GSM's LCD display can be adjusted. The LCD time of the GSM is the time delay of when the GSM display switches between the default welcome screen (see **Fig.38** for Art.4812 and **Fig.39** for Art.4812R on page 20) and a custom welcome screen or logo which has been uploaded to the panel using the GSMSK PC software.

The current setting will be highlighted on the second line of the screen (see **Fig.112**). The default LCD time is set to 000 (0 seconds = LCD switch time disabled) and can be adjusted from 0 seconds up to 255 seconds. Enter the LCD switch time required then to confirm and save the setting press the ENTER button and the screen will revert back to the time settings menu (refer to **Fig.104**).

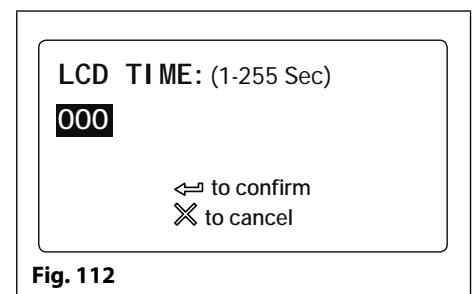

**Fig. 112**

# Programming via Text Message

## PROGRAMMING THE DIGITAL GSM INTERCOM

Programming the Digital GSM can also be carried out by sending text (SMS) messages.

**IMPORTANT NOTE:** When you are required to use " in a text message it is important to use the correct symbol and not for example ' (or two ' single apostrophes side by side which may look the same but will be interpreted differently by the digital GSM).

## PROGRAMMING BY TEXT MESSAGE

Programming by text message is a simple way to customise the settings of the digital GSM panel and to add or delete apartment programming remotely. This can include changing apartments telephone numbers, access codes, names or other settings. If a large number of telephone numbers need to be programmed it may be easier with the GSMSK PC software, refer to the manual GSMSK\_66251720\_EN\_V2-0 (or later).

Simply send texts in the following format shown below to the telephone number of the SIM within the digital GSM panel:

<4 DIGIT MASTER CODE> <3 DIGIT FUNCTION CODE> <OPTIONAL DATA> <OPTIONAL ?>

### 4 DIGIT MASTER CODE

This code prevents unauthorised access to the programmable features of the system. The code must be four digits long but can be any combination using digits 0 – 9. The default master code is 1111 and will be used for all examples in this manual.

### 3 DIGIT FUNCTION CODE

The 3 digit function code identifies the programmable feature to be changed. The code must be in capital letters. The following table lists the available codes.

DESCRIPTION	CODE	EXAMPLE	SETTINGS	DEFAULT	PAGE
Programming and storing user information in a new memory location	MEM	1111MEMnnn"1stNo.,"Div1", "Div2","Div3","AptNo.,"Code", DTO,TB,"Name"	* see below	n/a	47 - 48
Store or change an apartment code	STC	1111STCn:"cccccc"	n = <apt no.> cccccc = code	n/a	48
Enable/disable an apartment DTO setting	STO	1111STOn:O	n = <apt no.> O = 0 or 1	n/a	48 - 49
Assign a timeband TB to an apartment	STB	1111STBn:B	n = <apt no.> B = 1-9	n/a	49
Store or change an apartment name	STT	1111STTn:"ttttttttttttttt"	n = <apt no.> ttttttttttttttt = Name. Use a > to represent a space	n/a	49
Store a primary telephone no.	STN	1111STNn:"yyyyyyyyyy"	n = <apt no.>	n/a	50
Store divert 1 telephone no.	STD	1111STDn:"yyyyyyyyyy"	yyyyyyyyyy = telephone no. 30 digits max.	n/a	50
Store divert 2 telephone no.	STE	1111STEn:"yyyyyyyyyy"		n/a	50
Store divert 3 telephone no.	STF	1111STFn:"yyyyyyyyyy"		n/a	50
Store a primary telephone no. and divert no's in a single text message	STN	1111STNn:"pn","d1","d2","d3"  1111STNn:"01912243174", "01912241559","01912243678", "01912245326"	n = <apt no.> pn = primary no. d1 = divert 1 no. d2 = divert 2 no. d3 = divert 3 no.	n/a	50 - 51
Set call time	SPT	1111SPTnnn	nnn = 001 - 255	040 (40s)	51
Set relay time	RLT	1111RLTnnn	nnn = 001 - 255	005 (5s)	51
Set auxiliary output AO time	A1T	1111A1Tnnn	nnn = 001 - 255	005 (5s)	51
Set auxiliary output AO mode	A1M	1111A1Mnnn	nnn = 000 - 001	001	51
Keep connection facility	NOD	1111NODnnn	nnn = 001 - 099	000 (disabled)	51 - 52
Divert time	DIT	1111DITnnn	nnn = 001 - 099	015 (15s)	52
Check GSM signal strength	SIG	1111SIG?	n/a	n/a	52
Check firmware version	VER	1111VER?	n/a	n/a	52
Forced dial/dial a number	DLE	1111DLE"123"	n/a	n/a	52
Change 4 digit master code	CDE	1111CDE1234	Any 4 digits	1111	53
Change 4 digit admin code	CDA	1111CDA1234	Any 4 digits	2222	53
Change 4 digit trade code	CDT	1111CDT1234	Any 4 digits	0000	53
Trigger the relay	RLY	1111RLY	n/a	n/a	53
Trigger auxiliary output AO	A1O	1111A1O	n/a	n/a	53

## Programming via Text Message

Store balance check dial string	<b>SDL</b>	1111SDL"*#1345#"	n/a	n/a	53
Check credit balance	<b>BAL</b>	1111BAL?	n/a	n/a	53 - 54
Store a master telephone no.	<b>STM</b>	1111STM"07771234567"	n/a	n/a	54
Latch the relay	<b>RLA</b>	1111RLA	n/a	n/a	54
Unlatch the relay	<b>RUL</b>	1111RUL	n/a	n/a	54
Latch auxiliary output AO	<b>A1L</b>	1111A1L	n/a	n/a	54
Unlatch the auxiliary output AO	<b>A1U</b>	1111A1U	n/a	n/a	54
Store a timeband (for apartment calls and dial to open no's.)	<b>TBA</b>	1111TBAn"06002300"	HHMMHHMM	00002359	54 - 55
Check/set date & time	<b>CLK</b>	1111CLK"yy/mm/dd,hh:mm"?	yy/mm/dd,hh:mm	n/a	55
Silent dialling mode	<b>AUE</b>	1111AUEnnn	nnn = 000 or 001	001	55 - 56
Enable dial 0 on answer function	<b>EDZ</b>	1111EDZnnn?	nnn = 000 or 001	000	56
Enable the # (hash) function	<b>ED#</b>	1111ED#nnn?	nnn = 000 or 001	000	56
Enable proximity reader	<b>EPR</b>	1111EPRnnn?	nnn = 000 or 001	000	56
Proximity number of bytes to check	<b>PBY</b>	1111PBYnnn?	nnn = 002, 003 or 004	002	56 - 57
Store a fob/card in a known location <u>or</u> the next available location	<b>FOB</b>	1111FOBnnnn"site","user" <u>or</u> 1111FOB"site","user"	nnnn = 0000-1999 <u>or</u> nnn - optional	n/a	57 - 58
Find a fob or card	<b>FDf</b>	1111FDf"nnnnn"?	n/a	n/a	58
Delete a fob or card without knowing its location	<b>DEF</b>	1111DEF"12345"?	n/a	n/a	58
Free access timebands including output setup with latch or momentary trigger	<b>FRE</b>	1111FREn"HHMMHHMM",days:m:o	n = 0 - 9 HHMMHHMM days = Mo, Tu, We, Th, Fr, Sa, Su, AD, WD and WE m = L or M o = RL, A1	n/a	58 - 59
Clear all free access timebands	<b>FRD</b>	1111FRD?	n/a	n/a	59
Disable (001), enable individual (002) or enable combined (003) speech board	<b>SBM</b>	1111SBMnnn?	nnn = 001, 002 or 003	003	59
Set speech board volume	<b>SBV</b>	1111SBVnnn?	nnn = 000 - 099	75	59 - 60
Find a telephone number	<b>FDT</b>	1111FDT" number or ends in"?	n/a	n/a	60
End on Last Divert	<b>EOD</b>	1111EODnnn?	nnn = 000 or 001	000	60
Door or Gate	<b>GAT</b>	1111GATnnn?	nnn = 000 or 001	001	60 - 61
Shutdown and Restart	<b>RBT</b>	1111RBT	n/a	n/a	61
Initiate a special command	<b>PRG</b>	1111PRG(command)	AT commands	n/a	61
AT command to send at start up	<b>AT1</b>	1111AT1"ATxxxxx"?	Any AT command	n/a	61
AT command to send at start up	<b>AT2</b>	1111AT2"ATxxxxx"?	Any AT command	n/a	61
AT command to send at start up	<b>AT3</b>	1111AT3"ATxxxxx"?	Any AT command	n/a	61
Obtain the GSM's IMEI number	<b>IME</b>	1111IME?	n/a	n/a	61

### OPTIONAL DATA

The optional data will vary depending on the command used. It may be a telephone number, a time setting or may not be used at all. For more information refer to the following command settings.

### OPTIONAL ?

Most of the commands support the ? feature. When this is added to the end of the text message, a confirmation text message will be sent back to the sender indicating the new data has been received and stored.

When sending text messages there may be a delay from when you send the message to when it is received by the digital GSM intercom depending on how congested the network is. If you are at the door panel when sending the message you will here a single beep from the digital GSM intercom to indicate it has received the message.

## Programming via Text Message

### PROGRAMMING AND STORING USER INFORMATION IN A NEW MEMORY LOCATION (MEM)

The memory location in the digital GSM is simply a position within the GSM's internal memory where the user's apartment information is stored. Up to 500 user's can be stored in the digital GSM (memory locations 000 - 499).

There are 9 parts of user information that is stored in a memory location (also refer to pages 36 - 38):

1. Apartment number (APT);
2. Door/gate access code (CODE);
3. Dial to open number/setting (DTO/STO);
4. Timeband assignment (TB);
5. Username (NAME);
6. Primary telephone number (TEL1/STN);
7. First divert number (TEL2/Div1/STD);
8. Second divert number (TEL3/Div2/STE);
9. Third divert number (TEL4/Div3/STF).

**IMPORTANT NOTE:** Remember if programming an access code into memory location '000' it will only operate the auxiliary output AO for the programmed AO time (A1T) and not the onboard relay. Please also note that activating the auxiliary output in this way is only possible when the auxiliary output mode A1M has been set to mode 001.

**IMPORTANT NOTE:** It is important to remember that before any specific user information can be changed, e.g. apartment number, telephone numbers etc., these details must first be stored in a memory location in the digital GSM. Without this initial information no changes can be made as there would be no user information stored in the GSM's memory to change or edit.

To store a user's information in a memory location the SMS message must be sent in the following format:

**1111MEMnnn"TEL1";"TEL2";"TEL3";"TEL4";"APT";"CODE",DTO,TB,"NAME"?**

where:

- **1111** = 4 digit code;
- **MEM** = 3 digit function code;
- **nnn** = memory location (from 000 - 499);
- **TEL1** = primary telephone number (30 digits maximum);
- **TEL2** = first divert number Div1 (30 digits maximum);
- **TEL3** = second divert number Div2 (30 digits maximum);
- **TEL4** = third divert number Div3 (30 digits maximum);
- **APT** = apartment number (maximum of 6 digits including letters A - F);
- **CODE** = door/gate access code (maximum of 6 digits);
- **DTO** = dial to open enable (enter 1 to enable, leave blank or enter 0 to disable, also refer to page 37);
- **TB** = timeband assignment (from 1 - 9, leave blank or enter 0 for default timeband, also refer to pages 37 and 43);
- **NAME** = username (maximum of 16 characters where the > character can be used to insert a space between characters or words).

Where shown, (in the example above) the quotation marks " and commas , must be included as part of the line of programming text with no spaces. The ? at the end of the message is optional if a confirmation text is required.

The following text messages that can be sent to the digital GSM to program/store are as follows:

<b>1111MEMnnn"TEL1";"TEL2";"TEL3";"TEL4";"APT";"CODE",DTO,TB,"NAME"?</b>	Store the primary telephone number TEL1, first divert TEL2, second divert TEL3, third divert TEL4, apartment number APT, door/gate access code CODE, dial to open enable DTO, timeband assignment TB and username NAME in memory location nnn. A text message will be sent to the sender with the stored information for that memory location. Where nnn = memory location 000 - 499.
<b>1111MEMnnn?</b>	Query the apartment details stored in memory location nnn, where nnn = memory location 000 - 499.

The following example shows how to program a user's details:

## Programming via Text Message

**Example 1:** To program the following user's information: primary telephone number 01912243174, first divert 07791123456, second divert 07897654321, third divert 07999532641, apartment no. 123, door/gate access code 654321, dial to open enabled, timeband 3, username Videx Tech in memory location 150 and receive a confirmation text, the following SMS message can be sent.

**1111MEM150"01912243174","07791123456","07897654321","07999532641","123","654321",1,3,"Videx>Tech"?**

Note that quotation marks " and commas , are used where appropriate and the > character is used to insert a space between the words Videx and Tech for the username. The optional ? is included at the end so a confirmation text is sent back to the sender.

The digital GSM will store the above information in memory location 150 and send the following confirmation text back to the sender:

**MEM 150 APT = 123 CODE = 654321  
 DTO = 1 TB = 3 NAME = Videx Tech  
 TEL = 01912243174 TEL (DIVERT 1) = 07791123456  
 TEL (DIVERT 2) = 07897654321 TEL (DIVERT 3) = 07999532641  
 OKVIDEX GSM**

Using the same **MEM** programming command it is also possible to change all or only part of the user's details as well as delete part of a user's details that may no longer be required. To leave a particular user detail or setting unchanged simply don't enter anything in that section of the command but remember to add a comma ,. To delete part of the user's details simply use two quotation marks "" next to each other in that section of the **MEM** programming command.

Using the same user details from the previous example the next example shows how to change and delete only part of the user's details in memory location 150.

**Example 2:** If the user only needs to delete the door/gate access code, delete the third divert number and no longer requires the dial to open feature enabled and receive a confirmation text, the following SMS message can be sent.

**1111MEM150,,,,"",0,?**

Note that two quotation marks "" are used next to each other to delete a particular detail and commas , are used where details remain unchanged. The optional ? is included at the end so a confirmation text is sent back to the sender.

The digital GSM will amend the above information in memory location 150 and send the following confirmation text back to the sender:

**MEM 150 APT = 123 CODE =  
 DTO = 0 TB = 3 NAME = Videx Tech  
 TEL = 01912243174 TEL (DIVERT 1) = 07791123456  
 TEL (DIVERT 2) = 07897654321 TEL (DIVERT 3) =  
 OKVIDEX GSM**

### STORE OR CHANGE AN APARTMENT CODE (STC)

Each apartment can have a unique door/gate access code programmed which can be a maximum of up to 6 digits (also refer to the notes door/gate access code on page 37). The following text messages can be used to store/change, delete and query the access code stored for an apartment.

<b>1111STCn:"cccccc"</b>	Store a door/gate access code ccccc for apartment n, where ccccc = code (up to 6 digits max.) and n = apartment number.
<b>1111STCn:"cccccc"?</b>	Store a door/gate access code ccccc for apartment n, where ccccc = code (up to 6 digits max.) and n = apartment number. Also send a confirmation text back to the sender.
<b>1111STCn:""</b>	Delete a door/gate access code ccccc for apartment n, where ccccc = code (up to 6 digits max.) and n = apartment number.
<b>1111STCn: ""?</b>	Delete a door/gate access code ccccc for apartment n, where ccccc = code (up to 6 digits max.) and n = apartment number. Also send a confirmation text back to the sender.
<b>1111STCn:?</b>	Query the door/gate access code stored for apartment n, where n = apartment number. Also send a confirmation text back to the sender.

**IMPORTANT NOTE:** Remember that the apartment number n can be up to 6 digits in length including letters A - F.

### ENABLE/DISABLE AN APARTMENTS DTO (DIAL TO OPEN) SETTING (STO)

Each apartment can have their programmed telephone numbers set up as dial to open numbers. Once this feature is enabled for an apartment all the numbers stored for that apartment (primary and 3 divert numbers) will be set as dial to open numbers. If a user calls from any of the stored numbers the digital GSM will see that they are dial to open numbers and drop the call but activate the onboard relay to trigger the door/gate.



## Programming via Text Message

**IMPORTANT NOTE:** It is important to switch OFF voicemail and automatic SMS features on the SIM card in the digital GSM when using this feature (see the 'Forced Dial' DLE section for more details). Also note that it will not be possible to use the dial in to speak facility from a number stored to release the door/gate when dialling in (door release takes priority, refer to the priority function table on page 67).

Please also note it is important that the numbers stored, when dialling in to release the door/gate, must have any "caller ID" or "withheld number" function switched OFF on the telephone/mobile that is making the call to the digital GSM. If this feature is not switched OFF the GSM intercom will not recognise the caller's number and simply end the call with no action taken.

By default this feature is disabled (switched OFF). The following text messages can be used to enable or disable the dial to open feature.

1111STOn:O	Set the dial to open feature O for apartment n, where n = apartment number, O = 0 disabled (switched OFF) or O = 1 enabled (switched ON).
1111STOn:O?	Set the dial to open feature O for apartment n, where n = apartment number, O = 0 disabled (switched OFF) or O = 1 enabled (switched ON). Also send a confirmation text back to the sender.
1111STOn:?	Query the dial to open setting for apartment n, where n = apartment number, O = 0 disabled (switched OFF) or O = 1 enabled (switched ON). Also send a confirmation text back to the sender.

### ASSIGN A TIMEBAND (TB) TO AN APARTMENT (STB)

Each apartment can have a timeband TB assigned to it (also refer to notes on page 37 and 43 on setting up timebands). By default timeband 0 is already assigned to the apartment (timeband 0 is set to 00:00 - 23:59). There are 9 other programmable timebands (1 - 9) available for an apartment to be assigned to and each apartment can only be set to one timeband at any one time.

The following text messages can be used to assign (set) a timeband to an apartment.

1111STBn:B	Set the timeband B to an apartment n, where n = apartment number, B = timeband 1 - 9.
1111STBn:B?	Set the timeband B to an apartment n, where n = apartment number, B = timeband 1 - 9. Also send a confirmation text back to the sender.
1111STBn:?	Query the timeband set for an apartment, where n = apartment number. Also send a confirmation text back to the sender.

### STORE OR CHANGE AN APARTMENT NAME (STT)

An apartment name (usually the user's name) can be programmed into the digital GSM. The following text messages can be used to store, change, delete or query an apartment name (also refer to notes on page 37). The apartment name can be up to a maximum of 16 characters long.

1111STTn:"tttttttttttttt"	Store an apartment name (username) ttttttttttttt for apartment n, where n = apartment number, ttttttttttttt = apartment name (16 characters max.).
1111STTn:"tttttttttttttt"?	Store an apartment name (username) ttttttttttttt for apartment n, where n = apartment number, ttttttttttttt = apartment name (16 characters max.). Also send a confirmation text back to the sender.
1111STTn: ""	Delete the apartment name (username) for apartment n, where n = apartment number.
1111STTn: ""?	Delete the apartment name (username) for apartment n, where n = apartment number. Also send a confirmation text back to the sender.
1111STTn:?	Query the apartment name (username) stored for apartment number n, where = apartment number. Also send a confirmation text back to the sender.

The > symbol can be used to insert a space between characters or words, for example:

**Example:** To program the username Mr Smith for apartment 321 and receive a confirmation text, the following SMS message can be sent to the digital GSM.

1111STT321:"Mr>Smith"?

Note that quotation marks " and a colon : are used where appropriate and the > character is used to insert a space between the words Mr and Smith for the name. The optional ? is included at the end so a confirmation text is sent back to the sender.

The digital GSM will store the above username for apartment 321 and send the following confirmation text back to the sender:

APT = 321 NAME = Mr Smith  
OK VIDEX GSM

## Programming via Text Message

### STORE OR CHANGE THE APARTMENT TELEPHONE NUMBERS (STN, STD, STE AND STF)

Telephone numbers can be stored for the 500 available apartments. Each apartment can have up to four telephone numbers (if the first is busy or not answered in a certain time it can call a 2nd, 3rd and 4th number). The STN code stores the first number (primary telephone number) when the apartment is called. The STD (Div1), STE (Div2) and STF (Div3) codes stores the diverted telephone numbers if the first is busy or not answered (the digital GSM will divert to the 2nd number then divert to the 3rd number and finally the 4th number). The text messages to store, change or check numbers are as follows, replace STN with STD, STE or STF when storing/changing divert numbers.

<b>1111STNn:"yyyyyyyyyy"</b>	Store the primary telephone number yyyyyyyyyy for apartment number n.
<b>1111STNn:"yyyyyyyyyy"?</b>	Store the telephone number yyyyyyyyyy for apartment number n and send a confirmation text message to confirm storage of new number.
<b>1111STNn:?</b>	Query the telephone number stored for apartment number n. A text message will be sent to the sender with the stored number for that location.
<b>1111STNn:""</b>	Delete the telephone number stored for apartment number n.
<b>1111STNn:""?</b>	Delete the telephone number stored for apartment number n. A text message will be sent to the sender with the delete confirmation for that location.

n is an apartment number which can be made from up to a maximum of 6 digits including letters A - F. The telephone number yyyyyyyyyy can be a maximum of 30 digits. For example: to store the number 01912243174 for apartment 123 and include three divert numbers (if that one is not answered or busy, Div1, Div2 and Div3) of 01912241558, 07771234567 and 01912241559 respectively, the following SMS messages would be sent to the digital GSM:

```
1111STN123:"01912243174"
1111STD123:"01912241558"
1111STE123:"07771234567"
1111STF123:"01912241559"
```

To query any of these numbers for apartment 123 the following SMS messages would be sent to the digital GSM:

```
1111STN123:?
1111STD123:?
1111STE123:?
1111STF123:?
```

### STORE THE PRIMARY AND DIVERT NUMBERS FOR AN APARTMENT IN A SINGLE TEXT MESSAGE (USING STN)

It is also possible to program a primary telephone number and three divert numbers for a particular apartment in a single text message instead of using the individual programming codes STD (1st divert), STE (2nd divert) and STF (3rd divert). Expanding on the STN programming command the text messages used to store/check the primary number and divert numbers are as follows.

<b>1111STNn:"pn" (or 1111STNn:"yyyyyyyyyy")</b> <b>1111STNn:"pn",d1"</b> <b>1111STNn:"pn",d1",d2"</b> <b>1111STNn:"pn",d1",d2",d3"</b>	Store the primary number and respective divert numbers for apartment n, (where n = <apt no.> and pn = primary number, d1= 1st divert, d2 = 2nd divert, d3 = 3rd divert).
<b>1111STNn:"pn"?</b> (or 1111STNn:"yyyyyyyyyy"?) <b>1111STNn:"pn",d1"?</b> <b>1111STNn:"pn",d1",d2"?</b> <b>1111STNn:"pn",d1",d2",d3"?</b>	Store the primary number and respective divert numbers for apartment n, (where n = <apt no.> and pn = primary number, d1= 1st divert, d2 = 2nd divert, d3 = 3rd divert), also send confirmation of stored numbers for that location.

Using the same telephone numbers from the previous example: to store the primary number 01912243174 (pn) for apartment 252A and three divert numbers of 01912241558 (d1), 07771234567 (d2) and 01912241559 (d3) respectively, the following single text message would be sent to the digital GSM instead of sending 4 individual text messages:

```
1111STN252A:"01912243174",01912241558,07771234567,01912241559"
```

Similarly if only the primary number (pn) and 1st divert number (d1) were only required for apartment 252A the following message would be sent:

```
1111STN252A:"01912243174",01912241558"
```

Remember an optional ? can be included at the end of the message to receive confirmation of the stored numbers, like so:

```
1111STN252A:"01912243174",01912241558,07771234567,01912241559"?
```

The following reply will be received from the digital GSM:

## Programming via Text Message

APT 252A TEL = 01912243174  
 TEL (DIVERT 1) = 01912241558  
 TEL (DIVERT 2) = 07771234567  
 TEL (DIVERT 3) = 01912241559  
 OK VIDEX GSM

Remember to include " and , where appropriate.

### SET CALL TIME (SPT)

The call time is the maximum time in seconds that a call can last before the GSM panel automatically clears the call down. The time can be from 1 second up to 255 seconds and begins from when the call is made from the panel. The default time is 40 seconds. The following messages are used to set/check the maximum call time (also refer to notes on page 42).

1111SPTnnn	Store the call time nnn seconds, where nnn is the time in seconds.
1111SPTnnn?	Store the call time nnn seconds, where nnn is the time in seconds. Also send a confirmation text back to the sender.
1111SPT?	Query the current stored call time. A text message will be sent back to the sender showing the stored time.

### SET RELAY TIME (RLT)

The relay time can be set from 001 – 255 seconds or latching. To set the relay time for latched mode set the relay time to 000. In latch mode the relay will stay energised until the command is sent again (also refer to notes on page 43).

1111RLTnnn	Store the relay time nnn = time in seconds (e.g. nnn = 005, time = 5 seconds).
1111RLTnnn?	Store the relay time nnn = time in seconds. Also send a confirmation text back to the sender.
1111RLT?	Query the current stored relay time. A text message will be sent back to the sender showing the stored relay time.

### SET AUXILIARY OUTPUT AO TIME (A1T, FOR A1M MODE = 001 OR 002 ONLY)

The auxiliary output AO time can be set from 001 - 255 seconds or latching. To set the AO output time for latched mode set the auxiliary time to 000. In latch mode the AO output will stay triggered until the relevant command is sent again to unlatch the output (e.g. sending text message 1111A1O to the digital GSM) or during a call by pressing 6 on the telephone to reset the AO output. The latching mode option is only available when the AO output mode, A1M, is set to mode 001. Please refer to the A1M modes below for more details (also refer to notes on page 43).

1111A1Tnnn	Store the AO time nnn = time in seconds (e.g. nnn = 005, time = 5 seconds).
1111A1Tnnn?	Store the AO time nnn = time in seconds. Also send a confirmation text back to the sender.
1111A1T?	Query the current stored AO time. A text message will be sent back to the sender showing the stored AO time.

### SET AUXILIARY OUTPUT AO MODE (A1M, MODES 000 - 002)

The auxiliary output AO has three modes that can be set (also see additional notes on page 39):

**Call Activated:** nnn = 000

AO output will activate when a call begins and deactivate when a call ends. See example, **Fig.14** on page 12.

**User Activated:** nnn = 001 (default mode)

To activate the AO output press 6 on the telephone during a call or sending the text message 1111A1O to the digital GSM. The auxiliary output can also be activated by triggering the auxiliary input AI. See example, **Fig.15** on page 12.

**Call Activated (Timed):** nnn = 002

AO output will activate when a call begins and deactivate when the auxiliary output time (A1T) expires. See example, **Fig.16** on page 13.

1111A1Mnnn	Store the AO mode nnn = 000 - 002 (see modes above).
1111A1Mnnn?	Store the AO mode nnn = 000 - 002 (see modes above). Also send a confirmation text back to the sender.
1111A1M?	Query the current stored AO mode (see modes above). A text message will be sent back to the sender showing the stored AO mode.

### KEEP CONNECTION FACILITY (NOD)

In the event the digital GSM intercom panel is not used for long periods of time it could be possible that the network disconnects

## Programming via Text Message

it. To prevent this from happening it is possible to program a time period (from 001 – 099 days or disabled 000) to wait before the digital GSM intercom makes a short call to refresh the connection to the network. This time period is reset after each call made on the system and will only happen if the full time period elapses without any incoming or outgoing calls.

1111NODnnn	Store the time nnn = time in days (e.g. nnn = 007, time = 7 days).
1111NODnnn?	Store the time nnn = time in days. Also send a confirmation text back to the sender.
1111NOD?	Query the current stored time. A text message will be sent back to the sender showing the stored time.

### DIVERT TIME (DIT)

The divert time is the number of seconds to wait for a call to be answered before diverting to the 2nd, 3rd and 4th number. The default time is 15 seconds (the count down begins from when an apartment is called, but is refreshed when the telephone begins to ring) and can be set from 001 – 255 seconds (also see notes on page 42).

1111DITnnn	Store the divert time nnn = time in seconds (e.g. nnn = 015, time = 15 seconds).
1111DITnnn?	Store the divert time nnn = time in seconds. Also send a confirmation text back to the sender.
1111DIT?	Query the current stored divert time. A text message will be sent back to the sender showing the stored divert time.

**IMPORTANT NOTE:** Once the divert time is set on the digital GSM panel it is set for the same time for all divert numbers for all apartments stored in the digital GSM intercom. Each apartments divert numbers cannot have individual divert times set, e.g. if the divert time is set for 10 seconds then the divert time for apartment 1 will be the same as the divert time for apartment 321 and so on. Apartment 1 will not have a different divert time to apartment 321 it will be the same.

### CHECK GSM SIGNAL STRENGTH (SIG)

At any time the signal strength of the digital GSM can be checked (also see notes on understanding the signal strength on page 64). It is advisable that when the digital GSM is first setup and before any other programming is carried out to check the signal strength of the GSM intercom. If the signal strength is too low the digital GSM may not operate properly and therefore the GSM antenna will need to be repositioned to increase the signal strength. Use the following command to check the signal strength.

1111SIG?	Check the signal strength of the digital GSM intercom and send a confirmation text back to the sender.
----------	--

### CHECK FIRMWARE VERSION (VER)

It is possible to check the current version of firmware in the digital GSM. This may be necessary to see if an update is required for any additional features or updates on the digital GSM which may be included on later versions. Use the following command to check the software version.

1111VER?	Check the software version of the digital GSM intercom and send a confirmation text back to the sender.
----------	---

### FORCED DIAL/DIAL A NUMBER (DLE)

A useful feature of the digital GSM panel is its ability to call a number sent to it in a text message. This feature can be used when setting up the SIM card. For example, disabling the voicemail facility or disabling automatic SMS messages or missed calls. Any number up to 15 digits can be called and the call will last for a maximum of 40 seconds. The example below would switch off voicemail on a Vodafone SIM card. Substitute the Vodafone number for other service providers.

1111DLE"1210"	Dial 1210 for the intercom panel.
---------------	-----------------------------------

For UK customers other useful numbers which can be used with this feature are as follows. For other countries please check the service provider's web sites for other useful codes.

**IMPORTANT NOTE:** Although the following codes have been confirmed to work with the GSM intercom Videx offers no guarantee that other codes from other network providers will work.

	Vodafone	O <sup>2</sup>
DISABLE VOICEMAIL	1210	1760
DISABLE TEXT ALERTS	#148#	1760

**IMPORTANT NOTE:** Disabling voicemail and text alerts is very important as there is no way to retrieve either of these services from the digital GSM panel. Disabling these features will also prevent the intercom panel switching to voicemail or sending a text when dialling in from another phone.

## Programming via Text Message

### CHANGE THE 4 DIGIT MASTER CODE (CDE)

The four digit master code (by default = 1111) can be any combination of numbers between 0 - 9, but must be 4 digits long. The code allows access to the full programming menu and must be used when sending text messages to the digital GSM. Use the following message to change the four digit master code (also see notes on page 41).

1111CDEnnnn	Change the 4 digit master code to nnnn (where nnnn = new 4 digit master code).
-------------	--

### CHANGE THE 4 DIGIT ADMIN CODE (CDA)

The four digit admin code (by default = 0000) can be any combination of numbers between 0 - 9, but must be 4 digits long. The code allows access to the admin menu and must be used when sending text messages to the digital GSM. Use the following message to change the four digit admin code (also see notes on page 42).

1111CDAnnnn	Change the 4 digit admin code to nnnn (where nnnn = new 4 digit admin code).
-------------	--

### CHANGE THE 4 DIGIT TRADE CODE (CDT)

The four digit trade code (by default = 2222) can be any combination of numbers between 0 - 9, but must be 4 digits long. The trade code can only be used when a timeclock has been connected to the trade input (TRD terminal) on the digital GSM when a trade code facility is required. Use the following message to change the four digit trade code (also see notes on page 42).

1111CDTnnnn	Change the 4 digit trade code to nnnn (where nnnn = new 4 digit trade code).
-------------	--

### TRIGGER THE RELAY (RLY)

There are several ways to trigger the digital GSM relay. The first is to press button 3 on the telephone during a call and the relay will operate for the programmed time. Another way is to send the following text message.

1111RLY	Operate the digital GSM relay (for the programmed time).
1111RLY?	Operate the digital GSM relay (for the programmed time) and send a confirmation text back to the sender.

### TRIGGER AUXILIARY OUTPUT AO (A1O)

It is possible to trigger the auxiliary output AO for the programmed output time (A1T, also refer to page 43 for setting A1T time). Please note that this method of triggering auxiliary output AO is only possible when the A1M mode has been set to mode 001, also refer to page 39 and the example, **Fig.15** on page 12. Triggering the auxiliary output can be achieved by shorting terminals AI and GND on the digital GSM intercom, pressing button 6 on the telephone during a call or by sending the following text message to the digital GSM panel.

1111A1O	Trigger auxiliary output AO (for the programmed time).
1111A1O?	Trigger auxiliary output AO (for the programmed time) and send a confirmation text back to the sender.

### STORE BALANCE CHECK DIAL STRING (SDL)

Several network providers offer the facility to check available balance on their pay as you go tariffs. For example, on Vodafone the string is \*#1345# and on O2 the string is \*#10#. Other networks may also have this feature. Since the digital GSM intercom will not know the details of the network provider's SIM card which you have inserted it will be necessary to store the correct string in order to use the credit balance check features.

1111SDL"*#1345#"	Store the balance check string for a Vodafone pay as you go.
1111SDL"*#10#"	Store the balance check string for an O <sup>2</sup> pay as you go.

**IMPORTANT NOTE:** Videx are only aware of the balance check dial string codes for the network providers mentioned above. Check dial string codes for other networks are currently unavailable at this time. Please also note that this programming function is only applicable for pay as you go SIM cards.

### CHECK CREDIT BALANCE (BAL)

The balance can only be checked if the correct balance check string has previously been stored using the SDL code explained above. At any point the user will be able to send the following text message and the digital GSM intercom will reply with the current balance stored on the SIM card.

1111BAL?	Check current balance of the SIM in the digital GSM intercom and send a confirmation text back to the sender.
----------	---

In addition to this feature the digital GSM also has the facility to monitor the available credit and then text the user to inform them when the credit has fallen below £5.00, €5.00 or \$5.00. It will then remind the user with another text after every 5 calls until the

## Programming via Text Message

credit has either increased or if it runs out.

To use this feature, the following settings must first be made:

A Pay As You Go SIM card from a provider that offers this service (Vodafone, O2) must be used.

The correct balance check string must be stored using the **SDL** code (see store balance check dial string).

A mobile phone number that is to receive the 'balance low' text must be stored in the master telephone number location using the **STM** code (refer to 'store master telephone number' feature below).

### STORE A MASTER TELEPHONE NUMBER (STM)

The master telephone number is the number which will receive automatic balance updates when the balance gets low (if this feature is setup). To store a master telephone number the following programming texts can be sent to the digital GSM intercom.

1111STM"yyyyyyyyyy"	Store the telephone number yyyyyyyyyy.
1111STM"yyyyyyyyyy"?	Store the telephone number yyyyyyyyyy and send a confirmation text back to the sender.
1111STM?	Query the master telephone number stored. A text message will be sent to the sender with the stored master telephone number.
1111STM""	Delete the master telephone number stored.
1111STM""?	Delete the master telephone number stored and send a confirmation text back to the sender.

### LATCH THE RELAY (RLA)

It is possible to latch the digital GSM relay closed. This function is particularly useful if the GSM relay is connected to a gate controller and the user wishes to 'hold open' the gate. The following text message can be sent to the digital GSM intercom.

1111RLA	Latch the digital GSM relay to the C/NO position.
1111RLA?	Latch the digital GSM relay to the C/NO position and send a confirmation text back to the sender.

### UNLATCH THE RELAY (RUL)

If the digital GSM intercom relay has been latched it is possible to unlatch the relay with the following text message.

1111RUL	Unlatch the digital GSM relay back to the C/NC position.
1111RUL?	Latch the digital GSM relay to the C/NC position and send a confirmation text back to the sender.

**IMPORTANT NOTE:** The digital GSM relay can also be unlatched by pressing 3 on the telephone during a call.

### LATCH AUXILIARY OUTPUT AO (A1L)

Auxiliary output AO, like the onboard relay, can be latched. To latch auxiliary output AO the following text message can be sent to the digital GSM intercom.

1111A1L	Latch auxiliary output AO.
1111A1L?	Latch auxiliary output AO and send a confirmation text back to the sender.

### UNLATCH AUXILIARY OUTPUT AO (A1U)

Auxiliary output AO can also be unlatched. To unlatch auxiliary output AO the following text message can be sent to the digital GSM intercom.

1111A1U	Unlatch auxiliary output AO.
1111A1U?	Unlatch auxiliary output AO and send a confirmation text back to the sender.

### STORE A TIMEBAND FOR APARTMENT CALLS AND DIAL TO OPEN NUMBERS (TBA)

**IMPORTANT NOTE:** This feature relies on the network providers time zone setting and also if they support NITZ (Network Identity and Time Zone). First check the time/date is correct by sending the SMS message 1111CLK? (also refer to check intercoms time & date feature below). If the time/date returned is incorrect, it maybe that they do not support it. The clock can be set manually but any power cut will result in the time and date being lost unless battery backup is included.

The timeband feature allows a call to an apartment to be enabled for a specific time period. Remember there are 9 programmable timebands (1 - 9) available (also refer to notes on page 43). By default timeband 0 is set to 00:00 - 23:59 and cannot be re-programmed, any apartment assigned to timeband 0 will enable a call to go through to the apartment. Once a timeband has been programmed it can then be assigned to an apartment (see notes on page 37 and programming notes to **assign a timeband, STB**, on page 49).

## Programming via Text Message

Remember to always use 24hr clock notation and also ensure the **start time** is earlier than the **stop time**. Use the following text messages to store, query and delete a timeband.

1111TBA $n$ "HHMMHHMM"	Store the time period HHMMHHMM for timeband $n$ (where $n$ = timeband 1 - 9, the first HHMM is the <b>start time</b> and the second HHMM is the <b>stop time</b> ).
1111TBA $n$ "HHMMHHMM"?	As above but also send a confirmation text back to the sender with the stored setting.
1111TBA $n$ ?	Query the time period programmed for timeband $n$ (where $n$ = timeband 1 - 9). A text message will be sent to the sender with the stored HHMMHHMM time period for timeband $n$ .
1111TBA $n$ ""	Delete the programmed time period for timeband $n$ (where $n$ = timeband 1 - 9).
1111TBA $n$ ""?	Delete the programmed time period for timeband $n$ (where $n$ = timeband 1 - 9) and confirm deletion of the timeband.

The following example shows how to program a timeband:

**Example:** Programming a time period to start from 6:00am until 11:30pm for timeband 1. Store the time using the format HHMMHHMM. The first HHMM is the **start time** (i.e. receive calls from 0600, 6am in the morning) and the second HHMM is the **stop time** (i.e. calls will be received up until 2330, 11:30pm at night, as soon as the clock reaches 2331, 11:31pm calls to the apartment will stop).

1111TBA1"06002330"?

Note that quotation marks " are used where appropriate and 24hr clock notation is used. The optional ? is included at the end so a confirmation text is sent back to the sender.

The digital GSM will store the above time period for timeband 1 and send the following confirmation text back to the sender:

TB 1 06002330  
OKVIDEX GSM

Any apartment which is then assigned to timeband 1 will only receive calls between the hours of 06:00 in the morning until 23:30 at night, calls after 23:30, i.e. 23:31 onwards will stop.

### CHECK/SET DATE & TIME (CLK)

The check date and time feature relies on the network providers time zone setting (also refer to important note above). After a SIM has been placed into the digital GSM intercom and powered up the SIM will attempt to register with the network and automatically synchronise with the network providers time zone setting. The following text messages can be sent to the digital GSM to check and set the current time and date. The date and time format is as follows: yy/mm/dd, hh:mm, where yy = year, mm = month, dd = date and hh = hour, mm = minutes.

1111CLK?	Check current time & date and send a confirmation text back to the sender.
1111CLK"yy/mm/dd,hh:mm"	Set current time & date.
1111CLK"yy/mm/dd,hh:mm"?	Set current time & date and send a confirmation text back to the sender.

**Example:** Setting the current time & date to 10:05am, 24th April 2017, the following text can be sent to the digital GSM intercom:

1111CLK"17/04/24,10:05"?

Note that quotation marks " are used where appropriate. The optional ? is included at the end so a confirmation text is sent back to the sender. The digital GSM intercom will reply with the following text:

CLK = 17/04/24, 10.05  
OKVIDEX GSM

### SILENT DIALLING MODE (AUE)

When the digital GSM is calling the telephone number stored there is a choice of either hearing the ringing noise from the intercom panel or just hearing beeps to indicate a call is in progress.

- Ringing heard during calling: nnn = 001
- Beeps heard during calling: nnn = 000

The following text messages can be sent to the digital GSM intercom to enable (000), disable (001) or query the setting of the silent dialling feature.

1111AUE $nnn$	Set the silent dialling mode $nnn$ (where $nnn$ = 001 or 000).
---------------	--

## Programming via Text Message

1111AUEnnn?	Set the silent dialling mode nnn (where nnn = 001 or 000) and send a confirmation text back to the sender.
1111AUE?	Query the current mode stored. A text message will be sent back to the sender confirming which silent dialling mode has been set.

### ENABLE THE DIAL '0' ON ANSWER FUNCTION (EDZ)

When enabled this feature allows an incoming call to an apartment to be diverted to the programmed divert telephone number if the '0' button on the telephone has not been pressed after answering the call. This can be useful if the user's number has an answerphone service (or answer machine) and they do not want the call to be answered by this service or if the primary number (mobile no.) is switched off.

The default for this function is disabled (set to 000). The following texts can be used to enable or disable this function.

1111EDZnnn	Set the dial '0' function nnn: 001 or 000 (001 = enable, 000 = disabled).
1111EDZnnn?	Set the dial '0' function nnn: 001 or 000 (001 = enable, 000 = disabled) also send a confirmation text back to the sender.
1111EDZ?	Query the dial '0' mode set.

When this feature is set (enabled = 001) the user answering the call must press '0' on their phone to accept the call otherwise the call will be diverted to the next number.

### ENABLE THE '#' (HASH) FUNCTION (ED#)

Once enabled the user must press the # button on their phone before pressing any other button (also refer to user command table 1 on page 66) with the exception of when the user needs to enter the 4 digit master code "1111".

The user will have up to 3 seconds to press the user command button required (e.g. button 3 to activate the panel's relay), if the user doesn't press the next button within the 3 second window they will have to press the # button again.

The default for this function is disabled (set to 000). The following texts can be used to enable or disable this function.

1111ED#nnn	Set the # function nnn: 001 or 000 (001 = enable, 000 = disabled).
1111ED#nnn?	Set the # function nnn: 001 or 000 (001 = enable, 000 = disabled) also send a confirmation text back to the sender.
1111ED#?	Query the dial '#' mode set.

### ENABLE PROXIMITY READER (EPR)

The digital GSM features a built-in proximity fob/card reader. The proximity reader can be enabled or disabled depending on whether this feature is required. By default the setting for this is disabled (proximity reader switched off). The following programming text messages are used to enable or disable the proximity reader (also see notes on page 40).

1111EPRnnn	Set proximity reader nnn: 001 or 000 (001 = enabled, 000 = disabled).
1111EPRnnn?	Set proximity reader nnn: 001 or 000 (001 = enabled, 000 = disabled) and send a confirmation text back to the sender.
1111EPR?	Query proximity mode set. A text message will be sent back to the sender confirming if the proximity reader is enabled or disabled.

**IMPORTANT NOTE:** When an Art.4850R parallel reader is connected to the digital GSM (via the RS485 BUS terminals) and a programmed fob/card is presented to it then the fob/card will only operate the Art.4850R's relay even if the built-in reader on the digital GSM is disabled. The EPR function only enables and disables the digital GSM's built-in reader and not the Art.4850R expansion reader.

### PROXIMITY NUMBER OF BYTES TO CHECK (PBY, 002, 003 & 004)

This function of the built-in proximity reader will only be applicable if the proximity reader has been enabled (see EPR function above). After the proximity reader is enabled the number of bytes that the reader checks is dependant on which type of proximity fob/card is used (also refer to notes on page 40).

#### Understanding the Fob Format and Card Number

It is important to understand the relationship between the fob format and the card number when setting up the proximity reader to check for the correct number of bytes.

- **Fobs/Cards with 5 digit number (user code):** If a proximity fob/card has no site code but a 5 digit user code (e.g. 955/T or 955/C) the PBY format should be set to check for 2 bytes (002).
- **Fobs/Cards with 3 digit site code and 5 digit user code:** If using a fob/card with a 3 digit site code and 5 digit user code (e.g. PBX1E or PBX2) the PBY format can be set to check for 2 bytes (002) or 3 bytes (003).



## Programming via Text Message

- **Fobs/Cards programmed using the PROXE desktop reader:** If using the PROXE desktop reader the **PBY** format can be set to check for 2 bytes (002), 3 bytes (003) or 4 bytes (004).

By default the setting for this function is set to check for 2 bytes, '002'. The following texts can be used to change this setting.

1111PBYnnn	Set proximity reader to check for number of bytes nnn: 002, 003 or 004 (002 = check for 2 bytes, 003 = check for 3 bytes, 004 = check for 4 bytes).
1111PBYnnn?	as above and send a confirmation text back to the sender.
1111PBY?	Query the number of bytes that the digital GSM has been set to check for.

PBY setting	Description
2 bytes	Will read all fobs/cards types programmed.
3 bytes	Will not read fobs/cards programmed with only 2 bytes (5 digit) information.
4 bytes	Will not read fobs/cards programmed with only 2 bytes (5 digit) or 3 bytes (8 digit) information.

**IMPORTANT NOTE:** It is recommended that only one fob/card type is used to allow for easier setup and programming of the digital GSM reader. **Mifare cards cannot be used.**

### STORE A PROXIMITY FOB/CARD IN A KNOWN LOCATION (0000 - 1999) OR THE NEXT AVAILABLE LOCATION (FOB)

Once the built-in proximity reader has been enabled and the number of bytes to check for has been set (refer to the **EPR** and **PBY** setup) the proximity fobs/cards can be programmed into the digital GSM intercom. Fobs/cards that are programmed will also automatically work on an Art.4850R expansion reader when connected via the RS485 BUS terminals.

The digital GSM can store up to 2000 fobs/cards (0000 - 1999). The reader can be programmed with any one of the following fobs:

- **955/T or 955/C** = Videx fobs or cards. These fobs and cards have no site code and have a 5 digit user code, so the **PBY** function must be set to 002 (the default setting, checking for 2 bytes).
- **PBX1E or PBX2** = Portal Plus fobs or cards. These fobs and cards have a 3 digit site code and 5 digit user code, so the **PBY** function can be set to 002 or 003.

The following texts can be used to program fobs or cards.

1111FOBnnnn"site","user"	Store fob/card in location nnnn, where nnnn = the memory location from 0000 - 1999 of where the fob/card is actually stored (see examples below for each type of fob/card). The "site" and "user" code is the number printed on the fob/card.
1111FOBnnnn"site","user"?	As above and send a confirmation text back to the sender with the stored fob/card details.
1111FOBnnnn?	Query the fob/card stored in memory location nnnn and send a confirmation text back to the sender with the stored fob/card details.

The following examples show how to program each fob/card type:

**Example 1:** Programming a **955/T** or **955/C** with no site code, a 5 digit user code of **12345** and storing it in memory location **0001**, the following text can be sent to the digital GSM:

**1111FOB0001"0","12345"**

Note that quotation marks " and commas , are used where appropriate. For these fob/card types a '0' must be inserted for the "site" code.

**Example 2:** Programming a **PBX1E** or **PBX2** with a 3 digit site code of **123**, a 5 digit user code of **45678** and storing it in memory location **0010**, the following text can be sent to the digital GSM:

**1111FOB0010"123","45678"**

Note that quotation marks " and commas , are used where appropriate.

**IMPORTANT NOTE:** Remember when programming a proximity fob/card into memory location '0000' it will only operate the auxiliary output AO for the programmed AO time (A1T) and not the onboard relay. Please also note that activating the auxiliary output in this way is only possible when the auxiliary output mode A1M has been set to mode 001.

It should also be noted that if an Art.4850R parallel reader is connected to the digital GSM (via the RS485 BUS terminals) and a fob/card that has been programmed to memory location '0000' (with A1M mode set to mode 001 on the digital GSM) when the fob/card is presented to the Art.4850R reader it will activate the Art.4850R's relay and NOT the auxiliary output on the digital GSM.

Expanding on the **FOB** programming command it is also possible to store a fob/card into the next available memory location. This is particularly useful when programming additional fobs/cards into the digital GSM with existing fobs and cards that have already been programmed into it, but the locations of where they are stored is unknown. Using the **FOB** programming text string, but

## Programming via Text Message

omitting the **nnnn** (0000 - 1999) memory location from the command the following texts can be used to program fobs or cards to the next free memory location and confirm where the fob or card will be stored.

1111FOB"site","user"	Store fob/card in the next memory location available. The "site" and "user" code is the number taken directly from the fob/card.
1111FOB"site","user"?	Store fob/card in the next memory location available and send a confirmation text back to the sender with the memory location of where the fob/card is stored. The "site" and "user" code is the number taken directly from the fob/card.

### FIND A FOB OR CARD (FDF)

The find a fob or card feature allows the user to search and find the fob/card memory location (between 0000 - 1999) of where a proximity fob or card is stored in the digital GSM intercom. It locates the fob or card using the 5 digit user code printed on the fob (see the following example). The following text message can be used.

1111FDF"nnnnn"?	Find the fob/card memory location for user code nnnnn, where nnnnn = user code (5 digit user code printed on fob/card).
-----------------	---

**Example:** Find fob/card memory location of card no. **12345**, the following text can be sent to the digital GSM intercom:

**1111FDF"12345"?**

Note that quotation marks " are used where appropriate. The optional ? is included at the end so a confirmation text is sent back to the sender. The digital GSM intercom will reply with the following text:

**STORED IN nnnn  
OKVIDEX GSM**

where nnnn = memory location (0000 - 1999) of where the fob/card is stored.

### DELETE A FOB OR CARD WITHOUT KNOWING ITS LOCATION (DEF)

This feature allows the user to delete a fob or card without knowing the memory location of where it is stored. The feature uses the 5 digit user code printed on the fob/card to search through the memory locations where the fob/card data is stored and then deletes it from the digital GSM intercom. The following text message can be used.

1111DEF"nnnnn"?	Find the fob/card location with user code nnnnn and delete, where nnnnn = user code (5 digit user code printed on fob/card), also send a confirmation text back to the sender.
-----------------	--

**Example:** Delete fob/card card no. **54321**, the following text can be sent to the digital GSM:

**1111DEF"54321"?**

The digital GSM intercom will reply with the following text:

**DELETED  
OKVIDEX GSM**

### FREE ACCESS TIMEBANDS (0 - 9) INC. OUTPUT SETUP WITH LATCH OR MOMENTARY TRIGGER (FRE)

The digital GSM has up to 10 programmable free access timebands (0 - 9) that can be setup to operate the onboard relay or the auxiliary output **AO**. Both the relay and the auxiliary output can be set to latch or momentarily trigger for the programmed relay time or programmed auxiliary output time respectively. The free access timebands are programmed in a similar way as the timebands (**TBA**) with a **start** time and an **end** time (using 24hr clock notation) which can be set for a specific day or days of the week to be active for.

If the selected output (relay or auxiliary) is setup to latch, the free access timeband will automatically activate the output when the **start** time is reached and will deactivate the output when it reaches the **end** time (i.e. the selected output will stay latched for the duration of the timeband).

If the selected output (relay or auxiliary) is setup for momentary trigger, the free access timeband will automatically activate the output for the programmed output time when the **start** time of the timeband is reached. When the timeband reaches the **end** time the selected output will trigger again for the programmed output time, for example if the relay was setup to trigger for 5 seconds then the relay will activate for 5 seconds at the beginning of the timeband and then activate again for 5 seconds at the end of the timeband.

The following text messages can be used to setup the free access timebands to activate the digital GSM's relay or the auxiliary output and setup the selected output for latch or momentary trigger. For the list of days refer to the Days table below.

Days				
<b>Mo</b> = Monday	<b>Tu</b> = Tuesday	<b>We</b> = Wednesday	<b>Th</b> = Thursday	<b>Fr</b> = Friday
<b>Sa</b> = Saturday	<b>Su</b> = Sunday	<b>AD</b> = All days	<b>WD</b> = Week days only	<b>WE</b> = Weekends only

## Programming via Text Message

When including the day or days in the command they must be separated using a comma , between the codes required, also refer to the example below. Use the following text messages to store, query and delete a free access timeband.

<b>1111FREn"HHMMHHMM"days:m:o</b>	Store the time period for free access timeband n, where n = timeband no. (0 - 9) using this format: the first HHMM is the <b>start</b> time to be active from (i.e. 0845 for 8:45am in the morning) and the second HHMM is the <b>end</b> time that will stop being active from (i.e. 1930 for 7:30pm at night), where days = Mo, Tu, We, Th, Fri, Sa, Su, AD, WD, WE, output trigger m = L for latch or M for momentary and output selection o = RL for relay, AO for the auxiliary output.
<b>1111FREn"HHMMHHMM"days:m:o?</b>	As above and also send a confirmation text back to the sender of programmed free access timeband period including day(s) active for, output trigger and output selection.
<b>1111FREn?</b>	Query the information stored for free access timeband n, where n = free access timeband number (0 - 9), also send a confirmation text back to the sender.

**Example:** To program free access timeband number 4 to latch the digital GSM's relay between 9:45am until 10:45am for Monday, Tuesday and Friday only, the following text can be sent to the digital GSM:

**1111FRE4"09451045"Mo,Tu,Fr:L:RL?**

Note that in this example no comma , is required to separate the time period and days selection. A ? has been included to receive a confirmation text. The digital GSM will reply with the following text:

**FA4 =09451045,Mo,Tu,Fr,L,RL  
OK VIDEX GSM**

In this example the reply from the digital GSM confirms the relay has been setup to latch for Monday, Tuesday and Friday only for free access timeband number 4 between 9:45am until 10:45am.

**IMPORTANT NOTE:** If the selected output (relay: RL or auxiliary: AO) is setup for a momentary trigger the output will trigger for the programmed output time. Remember to set the output time using the respective programming code, i.e. for the relay use 1111RLTnnn? and for the auxiliary output use 1111A1Tnnn?

It should also be noted that when any of the outputs have been setup with free access the free access feature takes priority over other programming or modes that may have been setup for the output.

### CLEAR ALL FREE ACCESS TIMEBANDS (FRD)

It is also possible to clear and reset all the free access timebands. The following text message can be used clear all the free access timebands.

<b>1111FRD?</b>	Delete all free access timebands, also send a confirmation text back to the sender.
-----------------	---

### DISABLE OR ENABLE SPEECH BOARD (SBM)

The digital GSM intercom includes call progress speech annunciation which can be either enabled or disabled. There are three options available:

- when set to 001 the speech board is disabled (switched off);
- when set to 002 the speech board is enabled with individual number speech playback;
- when set to 003 the speech board is enabled but with combined number speech playback.

By default this function is enabled with combined speech playback (003). The following text messages can be used to enable or disable this feature (also see notes on page 40).

<b>1111SBMnnn</b>	Disable or enable speech board nnn: 001, 002 or 003 (001 = disabled, 002 = enabled with individual playback or 003 = enabled with combined playback).
<b>1111SBMnnn?</b>	Disable or enable speech board nnn: 001, 002 or 003 (001 = disabled, 002 = enabled with individual playback or 003 = enabled with combined playback). Also send a confirmation text back to the sender.
<b>1111SBM?</b>	Query the speech board status/setting.

### SET SPEECH BOARD VOLUME (SBV)

The volume setting of the speech board in the digital GSM can be adjusted. The default volume level is set to 75, but can be set anywhere between 000 (low) up to 099 (high). The following text messages can be used to increase or decrease the volume level and query the current speech board volume setting stored (also see notes on page 40).

<b>1111SBVnnn</b>	Increase or decrease speech board volume nnn, where nnn = 000 (low) - 099 (high).
-------------------	---

## Programming via Text Message

1111SBVnnn?	Increase or decrease speech board volume nnn, where nnn = 000 (low) - 099 (high), also send a confirmation text back to the sender.
1111SBV?	Query the speech board volume setting.

### FIND A TELEPHONE NUMBER (FDT)

The find a telephone number feature allows the user to find the memory location (between 0000 - 0499) of where a particular telephone number (the primary number or any of the 3 divert numbers) is stored in the digital GSM. It can locate the number either from using the full telephone number or a minimum of the last 4 digits of a number (see following examples). The following text messages can be used.

1111FDT"yyyyyyyyyy"?	Find the memory location of where the telephone number yyyyyyyyyy is stored, where yyyyyyyyyy = telephone number (minimum of 4 digits).
----------------------	---

**Example 1:** To find the memory location of where the telephone number **01234567890** is stored using the full number, the following text can be sent to the digital GSM:

**1111FDT"01234567890"?**

Note that quotation marks " and commas , are used where appropriate. The optional ? is included at the end so a confirmation text is sent back to the sender. The digital GSM intercom will reply with the following text:

**STORED IN nnnn  
OK VIDEX GSM**

where nnnn = the memory location between 0000 - 0499 of where the number is stored.

**Example 2:** To find the memory location of where the telephone number ending in **4567** is stored using the last 4 digits of the number only, the following text can be sent to the digital GSM:

**1111FDT"4567"?**

Note that quotation marks " and commas , are used where appropriate. The optional ? is included at the end so a confirmation text is sent back to the sender. The digital GSM intercom will reply with the following text:

**STORED IN nnnn  
OK VIDEX GSM**

where nnnn = the memory location between 0000 - 0499 of where the number is stored.

**Example 3:** If the FDT search function is used to locate a telephone number that is not stored the digital GSM will reply with the following text:

**NOT FOUND  
OK VIDEX GSM**

### END ON LAST DIVERT (EOD)

The end on last divert feature allows the digital GSM to ring each programmed divert number as usual and if the divert number is not answered it will then proceed to ring the next programmed divert number, if however there is no divert number stored the digital GSM will simply end the call.

By default this feature is disabled (set to 000), but can be enabled (set to 001). The following programming commands can be used to set/check the end on divert function.

1111EODnn	Set end on last divert to nnn, where nnn = 000 (disabled) or 001 (enabled).
1111EODnn?	Set end on last divert to nnn, where nnn = 000 (disabled) or 001 (enabled). Also send a confirmation text back to the sender.
1111EOD?	Query the end on last divert status stored in the digital GSM module.

### DOOR OR GATE (GAT)

This command feature of the digital GSM allows the internal speech board to change the default speech announcement that is heard from the intercom when the onboard relay is activated. For this feature to be heard the internal speech board must be switched ON (refer to notes on enabling/disabling the speech board, **SBM**, on pages 40 and 59).

By default the mode of this feature is set to '001', whereby the internal speech board will announce "**the gate is open**" when the onboard relay is activated. The alternative mode can be set to '000', whereby the internal speech board will announce "**the door is open**". To set the required door/gate mode the following commands can be sent to the digital GSM intercom (also see notes on page 41).

## Programming via Text Message

1111GATnnn	Set the speech board annunciation to mode nnn: 001 or 000 (001 = "the gate is open", 000 = "the door is open").
1111GATnnn?	Set the speech board annunciation to mode nnn: 001 or 000 (001 = "the gate is open", 000 = "the door is open") also send a confirmation text back to sender.
1111GAT?	Query the speech board annunciation mode set.

### SHUTDOWN AND RESTART (RBT)

This command feature allows the digital GSM to be remotely shutdown and then rebooted again. The following command can be sent to the GSM intercom.

1111RBT	Shutdown and restart the digital GSM intercom.
---------	--

**IMPORTANT NOTE:** This feature should not be confused with the 'hard-wired' reset (described on page 21). The RBT function simply powers down the digital GSM panel and then powers it back up again.

The following commands are reserved for the technical department for interrogating the digital GSM when testing and applying specific additional features that are not covered in this technical manual. For the application of these commands please contact Videx Technical on tel: 0191 224 3174. For overseas customers please contact Videx customer support on tel: (+39) 0734 631 699.

### INITIATE A SPECIAL COMMAND (PRG)

This is an advanced feature of the system which can allow an 'AT' format command to be sent to the OEM GSM module.

1111PRG(command)	Send an 'AT' command to the OEM module.
------------------	---

### AT COMMAND TO SEND AT START UP (AT1, AT2 AND AT3)

The AT commands AT1, AT2 and AT3 are advanced commands of the digital GSM that allows additional features to be incorporated into the module for testing purposes and include additional features for a specific application that is not already covered in this manual. The following commands can be sent to the digital GSM.

1111AT1"ATxxxxxx"?	Include any AT command for AT1.
1111AT2"ATxxxxxx"?	Include any AT command for AT2.
1111AT3"ATxxxxxx"?	Include any AT command for AT3.

### OBTAIN THE GSM'S IMEI NUMBER (IME)

If the IMEI number (unique 15 digit number of the main internal hardware chip) of the digital GSM is required the following text message can be sent to obtain the number.

1111IME?	Query IMEI number of the GSM module, also send confirmation to the sender.
----------	--

**Example:** Obtain IMEI number of the GSM module, the following message can be sent to the digital GSM intercom:

1111IME?

The digital GSM will reply with the following text:

IMEI-357803045065535  
OK VIDEX GSM

**IMPORTANT NOTE:** If installing the digital GSM for the first time, when registering the SIM card with the chosen network provider you may be asked for the IMEI number of the GSM module. As the programming command described above will only work with a SIM card that has already been registered with a network the command will not work.

Therefore in order to obtain the GSM's IMEI number, which is located on the main hardware chip internally, use a SIM that is already registered with another network provider and fit it into the digital GSM module (following the procedure on page 20 for initialisation), then use the programming command above 1111IME? to obtain the GSM's IMEI number, so that when registering the actual SIM that will be used with the GSM module with the chosen network, you will have the appropriate IMEI number to hand.

# The GSM Mobile App

## THE VIDEX SMS WIZARD

In addition to programming by direct text messages, via the digital GSM's keypad or using the GSM SK programming software it is also possible to program the GSM intercom using the GSM mobile app, the Videx SMS Wizard.

The SMS wizard can be used to simplify the programming of the GSM intercom using SMS messages.



The SMS wizard generates the text message required to communicate with the GSM intercom. Depending on the model of the GSM (digital GSM, GSM PRO, GSM Lite, GSMVRK and 2270 GSM module) text messages can be generated to program features such as access codes, proximity access fobs/cards, dial to open (DTO) telephone numbers, free access periods and call button/apartment telephone numbers.

Other features are also included to simplify the programming setup process. Additionally it is also possible for users to control their gate or door via the dial to open (DTO) or text message features.

## WHERE TO DOWNLOAD THE SMS WIZARD AND GETTING STARTED

The SMS wizard is available for both Android smart devices (mobile smartphones and tablets) and also Apple iOS (iPhones and iPads) and can be downloaded for free from the Google Play Store (for Android devices) and the App Store (for iOS devices).

Before using the SMS wizard the following details will be required for initial setup:

- **Model of the GSM intercom module** - e.g. Art.4810 (GSM PRO), Art.4812 or Art.4812R (digital GSM) etc.
- **Firmware level of the GSM intercom** - e.g. for the Art.4812R digital GSM the firmware might be **DG3.0.5** (the firmware version of the GSM module can usually be found on the label on the back of the GSM intercom or by sending the text message **1111VER?** to obtain the firmware version, also refer to notes on page 52).
- **Telephone number of the GSM intercom** - i.e. the mobile number of the SIM card being used in the GSM module.
- **Master code of the GSM intercom** - i.e. the 4 digit code used for programming, by default this is set to '1111'. In the event that this code has been forgotten or lost please refer to '**change the 4 digit master code (CDE)**' notes on page 53 or '**resetting the master code to 1111**' notes on page 21 to reset the code back to factory default if required.

Once downloaded and installed it is recommended that you first tap on the help icon (?) in the top right corner of the app's homescreen and then follow the '**TO GET STARTED**' quick guide.

It should also be noted when navigating between the app's menu to the required programming screens the help icon (?), always located in the top right corner of each screen, can be used to offer additional guidance on how to use the current programming screen.

## SMS WIZARD APP COMPATIBILITY

The SMS wizard is compatible with the latest GSM intercoms and modules available. It is also compatible with the older Art.4810N model from firmware version 1.0.4 onwards.



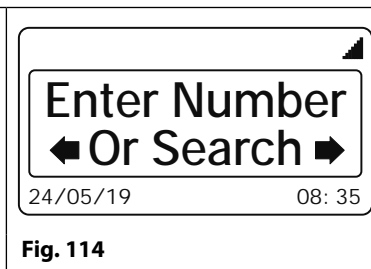
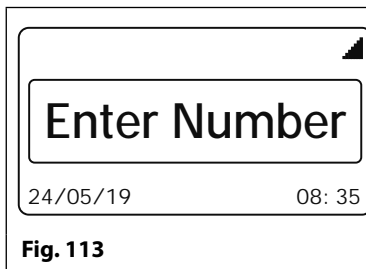

# System Operation

## STANDBY MODE

When the digital GSM intercom is in standby the display will show the standard welcome message, refer to **Fig.113** (Art.4812) and **Fig.114** (Art.4812R). The date and time is shown along the bottom of the display and the signal is indicated at the top right corner of the display.



## MAKING A CALL

To make a call, from standby, simply enter the apartment number to be called (e.g. apartment 2) and then press the ENTER button , see **Fig.115**. On the panel with the scroll facility use the scroll buttons ,  to search for the required apartment number and then press the CALL button , see **Fig.116**. The digital GSM will call the apartment (the primary number), see **Fig.117**. If an incorrect apartment number has been entered/selected simply press the CLEAR button  and start again. The panel will cancel the call to the apartment, see **Fig.118**.

If the speech board is switched ON the panel will announce the following:

“calling two”, if apartment 2 was being called, **Fig.117**.

“call cancelled”, if the call was cancelled, **Fig.118**.

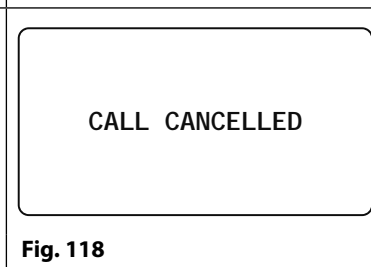
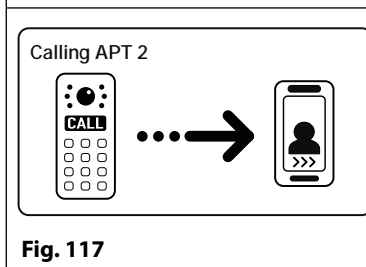
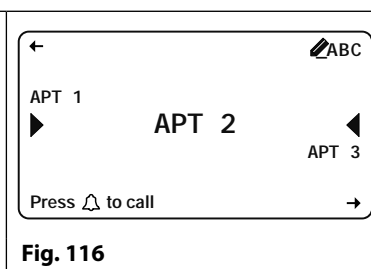
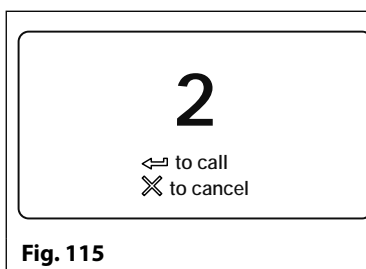

## DIVERTED CALL

First make a call from the digital GSM intercom following the steps above ‘making a call’. If any divert numbers are programmed and the primary number is not answered the panel will then dial the divert number(s) after the programmed divert time has elapsed. The panel display will still show that a call is in progress (see **Fig.117**). If the speech board is switched ON then the GSM intercom will announce “please wait”, this will indicate that the call has been diverted to the first divert number. This process will repeat again if a 2nd and 3rd divert number has been programmed into the panel.

## ANSWERING A CALL AND OPERATING THE DOOR/GATE

After a call has been made and then answered both the caller and user can start a conversation.

The GSM intercom display will indicate this when the call has been answered and the line is open, see **Fig.119**.

During a conversation the user can operate the door (see **Fig.120**) or gate (see **Fig.121**) by pressing ‘3’ on their mobile/telephone.

The user also has some limited programming and operational functions available to them e.g. adjusting mic and speaker volumes, latching and unlatching the onboard relay and activating the auxiliary output (depending on the operating mode of the auxiliary output), for these user functions please refer to user command table 1 on page 66.

If the speech board is switched ON the panel will announce one of the following:

“the door is open”, if the GAT feature is set to 000, **Fig.120**.

“the gate is open”, if the GAT feature is set to 001, **Fig.121**.

Also see GAT programming notes on pages 60 - 61.

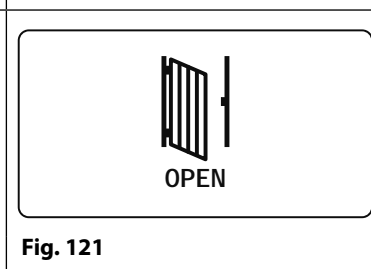
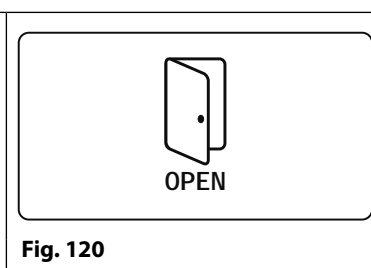
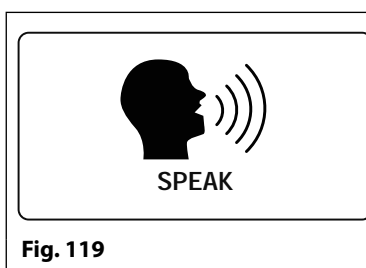

## System Operation

### ENTERING A DOOR/GATE AND TRADE ACCESS CODE

If an access code is programmed into the GSM intercom first press the '0' button, the 'ENTER A CODE' screen will appear on the display, see **Fig.122**.

The access code can be entered using the alpha-numeric keypad.

If an incorrect digit has been entered press the CLEAR button

(to delete the most recent digit entered).

Re-enter the correct digit again and so on until the correct access code has been entered followed by the ENTER button , see **Fig.123**.

If an incorrect code or a code that is not stored in the digital GSM is entered, after the ENTER button has been pressed, the display will show **not found**, see **Fig.124**.

If the speech board is switched ON the panel will announce one of the following:

“the door is open”, if the GAT feature is set to 000 and the correct code entered, **Fig.120**.

“the gate is open”, if the GAT feature is set to 001 and the correct code entered, **Fig.121**.

“you have entered and incorrect number, please try again”, if an incorrect code has been entered, **Fig.124**.

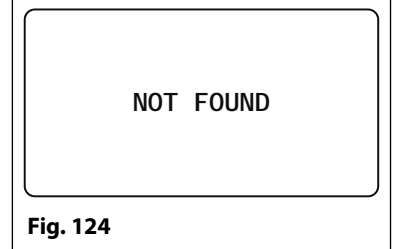
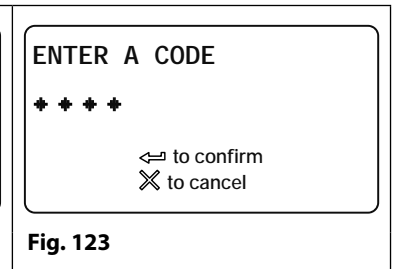
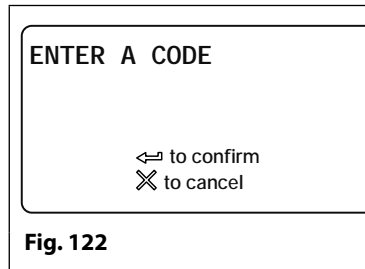

### ENTERING A TRADE CODE

If a trade code is programmed into the panel (this will require the use of the Art. 701T timeclock set in timeclock mode and connected into the TRD terminal, refer to **Fig.12** on page 11) follow the same steps as if entering a door/gate code. It is important to note that the panel's trade facility is **not** related to the timeband feature TBA.

### USING THE BUILT-IN PROXIMITY READER

If the proximity reader facility is being used this can be confirmed if the key symbol is shown at the top of the LCD graphical display, see **Fig.125** and **Fig.126**. The user can present the programmed fob/card in front of this symbol to operate the door/gate, see **Fig.127** and **Fig.128**.

It should be noted that even if a proximity fob or card is programmed into the digital GSM intercom, if the proximity facility is not enabled then the fob/card will not operate the door/gate.

If the speech board is switched ON the panel will announce one of the following:

“the door is open”, if the GAT feature is set to 000 and a programmed fob or card is presented, **Fig.120**.

“the gate is open”, if the GAT feature is set to 001 and a programmed fob or card is presented, **Fig.121**.

“invalid code” and also emit a long beep, if a fob or card that is presented to the reader is **not** programmed into the digital GSM, **Fig.129**.

Additional user operations can be carried out via text messaging following user command table 2 on page 66.

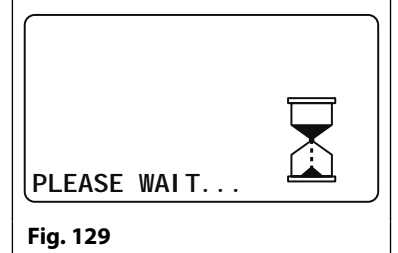
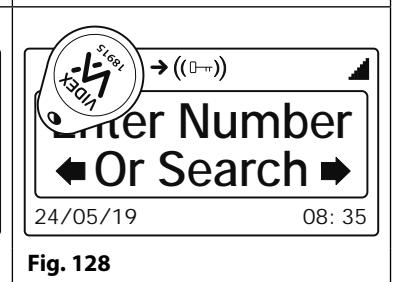
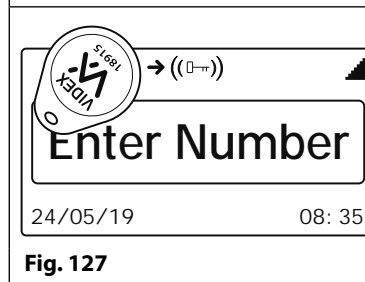
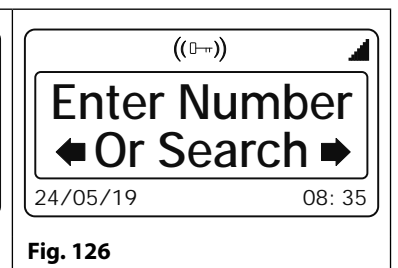
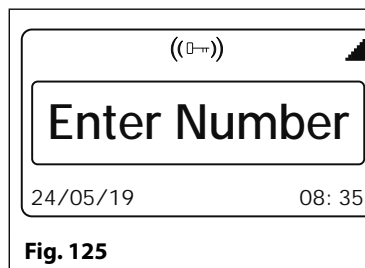

### RELEASING THE DOOR/GATE BY DIALLING THE DIGITAL GSM INTERCOM (DIAL TO OPEN DTO)

This feature is only possible if the dial to open, DTO, feature has been enabled on the digital GSM intercom (refer to **Fig.75** and notes on page 37). When this feature is enabled the primary number and the 3 divert numbers will be set as dial to open numbers. A call from any of these stored numbers to the digital GSM will result in the panel dropping the call and then opening the door/gate for the programmed relay time RLT.



## System Operation

### USING AN ART. 4850R EXPANSION READER (IF CONNECTED)

If an Art.4850R expansion reader is connected (refer to **Fig.20** and notes on page 16) and if the speech board is switched ON the digital GSM panel will announce one of the following:

“the door is open”, if the **GAT** feature is set to **000** and a programmed fob/card is presented to it. Also the LED on the Art.4850R will change from amber to green and emit a confirmation beep and operate its own relay (not the digital GSM's relay).

“the gate is open”, if the **GAT** feature is set to **001** and a programmed fob/card is presented to it. Also the LED on the Art.4850R will change from amber to green and emit a confirmation beep and operate its own relay (not the digital GSM's relay).

“invalid code” and also emit a single beep, a brief pause followed by a short then long beep. Also the reader's LED will change from amber to red if a fob or card that is presented to the reader is **not** programmed into the digital GSM. The relay will **not** operate.

**IMPORTANT NOTE:** Whenever a fob/card is presented to the Art.4850R expansion reader the display of the digital GSM will remain the same, i.e. it will continue to show the default welcome screen, refer to **Fig.113** and **Fig.114** on page 63, regardless of which one of the actions described above takes place.

### ACTIVATING THE AUXILIARY OUTPUT AO USING AN ACCESS CODE OR BY USING A FOB/CARD

#### Using an Access code:

Activating the auxiliary output AO using an access code will only be possible if the access code has been stored in memory location ‘000’.

To activate the auxiliary output AO using a code simply enter the code following the same door/gate code steps described on page 63.

The the digital GSM will show ‘OK’ on the display to confirm the auxiliary output AO has been activated, see **Fig.130**, and emit a series of beeps in line with the auxiliary output time **A1T**, e.g. if **A1T** is set to 5 seconds then 5 beeps will be heard.

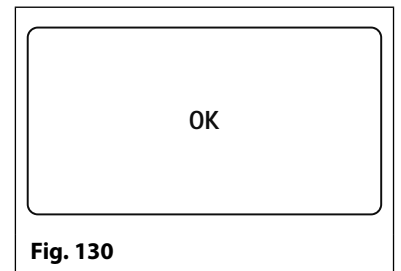

**Fig. 130**

#### Using a Proximity fob/card:

Activating the auxiliary output AO using a programmed fob or card will only be possible if the auxiliary output mode **A1M** has been set to mode ‘001’ and a fob/card has been stored in memory location ‘0000’.

To activate the auxiliary output AO simply present the fob/card to the onboard reader on the digital GSM, the GSM's display will show ‘OK’ to confirm the auxiliary output AO has been activated, see **Fig.130**, and emit a series of beeps in line with the auxiliary output time **A1T**, e.g. if **A1T** is set to 8 seconds then 8 beeps will be heard.

**IMPORTANT NOTE:** Even when the digital GSM's speech board is switched ON when activating the auxiliary output AO by code or proximity fob/card only the display will show ‘OK’, **Fig.130**, no speech annunciation will take place. The exception to this is when a programmed fob/card (stored in memory location ‘0000’) is presented to an Art.4850R expansion reader, the expansion reader will emit a single beep, the LED on the Art.4850R will change from red to green and operate it's own relay and **not** the digital GSM's relay for the programmed relay time of the Art.4850R. In this instance with the digital GSM's speech board switched ON it will announce either “the door is open” or “ the gate is open” depending on whether the GAT feature is set to ‘000’ or ‘001’ respectively.

# User Commands

## USER COMMAND TABLES

The first user table shows the user commands that can be carried out during a call. Successful commands are signalled by two beeps from the telephone, errors are signalled by four beeps.

**IMPORTANT NOTE:** When the ED# function has been enabled the user must press the # button on their phone before pressing any of the following user commands (also refer to page 56 for further information).

Table 1

FUNCTION	1st KEY TO PRESS	2nd KEY TO PRESS
Latch the relay (unlatch by pressing 3)	1	0
Release the door or gate	3	n/a
Activate auxiliary output AO <sup>1</sup>	6	n/a
Adjust door speech volume (digital GSM speaker)	4	0 - 9 (0 = lowest, 9 = highest)
Adjust phone speech volume (digital GSM mic)	7	0 - 9 (0 = lowest, 9 = highest)

<sup>1</sup> Activating auxiliary output AO in this way is only possible when A1M mode has been set to mode 001 (also see **Fig.15** and notes on page 12 and also notes on page 51, **set auxiliary output AO mode**) and will operate for the programmed A1T time. If the AO output time has been set to latch simply press 6 on the phone to unlatch the output again.

The second user table shows the SMS text messages that can be sent to the digital GSM intercom while in standby (the examples shown in the table use the default 4 digit master code 1111). Successful text commands are signalled by a single beep from the digital GSM and where the ? is used the appropriate confirmation text returned. Unsuccessful text commands are signalled by a long beep followed by a short beep from the digital GSM and where the ? is used the error message text returned, as shown in **Fig.131**.

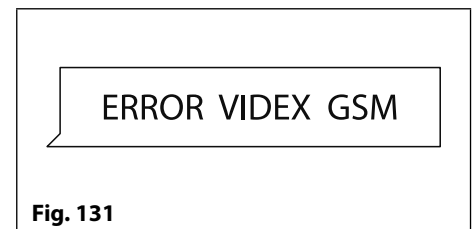

Fig. 131

Table 2

FUNCTION	MESSAGE TO SEND
Check the signal strength	1111SIG?
Check the available balance <sup>2</sup>	1111BAL?
Check the software version	1111VER?
Release the door/gate	1111RLY? (? optional, send if confirmation is required)
Latch the relay	1111RLA? (? optional, send if confirmation is required)
Unlatch the relay	1111RUL? (? optional, send if confirmation is required)
Activate auxiliary output AO	1111A1O? (? optional, send if confirmation is required)
Latch auxiliary output AO	1111A1L? (? optional, send if confirmation is required)
Unlatch auxiliary output AO	1111A1U? (? optional, send if confirmation is required)
Check Timeband setting (for apartment calls and dial to open numbers DTO)	1111TBAn? (where n = timeband 1 - 9)
Check Free Access Timeband setting	1111FREn? (where n = free access timeband 0 - 9)
Check Intercom Time and Date	1111CLK?
Find a Telephone Number - primary or divert no's, including dial to open (DTO) no's - (0000 - 0499)	1111FDT"yyyyyyyyyy"? (where yyyyyyyyyy = telephone number, minimum of 4 digits, also refer to notes on page 60)
Find a Fob or Card location (0000 - 1999)	1111FDF"nnnnn"? (where nnnnn = 5 digit user code printed on fob/card, also refer to notes on page 58)

<sup>2</sup> The balance can only be checked if the correct balance check string has been stored (also see **SDL** notes on page 53). This feature is only applicable for pay-as-you-go SIM cards.

# Additional User Information

## UNDERSTANDING THE SIGNAL STRENGTH (SIG) AND BIT ERROR RATE (BER)

When a request for signal strength message is sent to the digital GSM intercom it will reply with a two part code.

The first part of the code is a signal strength code **SIG** which will be between 0 – 31 or 99. Ideally the signal strength should be as close to 31 as possible for the best possible performance. The lower the number, the weaker the signal. Signal strengths lower than 10 may cause operational problems such as loss of speech quality (and possibly missing DTMF tones) and/or network loss. A signal strength of 99 indicates it could not be detected.

The second part of the code is the bit error rate **BER**. The bit error rate is used in digital telecommunication as a figure of merit for how effectively the receiver (in this case the digital GSM intercom) is able to decode transmitted data (the data in this instance are the various text message commands used to program the digital GSM intercom, described on pages 45 - 61, speech and DTMF signals used by the digital GSM intercom for normal operation). It is the percentage of bits that have errors relative to the total number of bits received in a transmission. Ideally the **BER** code should be as close to 0 as possible, the lower the **BER** the better. High **BER** codes can be caused by noise, interference, distortion or bit synchronisation errors over the transmission of data to the digital GSM intercom and as a result the problems described above (loss of speech quality, possibly missing DTMF tones and/or network loss etc.) can occur.

The example below shows the ideal reply to expect when the signal strength query **1111SIG?** is sent to the digital GSM intercom:

**SIGNAL = 31**  
**BER = 0**  
**OK VIDEX GSM**

To achieve the best overall performance from the digital GSM intercom a high signal strength **SIG** and low bit error rate **BER** is required. In the event that a low signal strength and high bit error rate is received it is recommended that the **Art.432** antenna is repositioned, where permissible, at the highest point to achieve the best signal. Where this is not possible an alternative high gain antenna can be used, in particular Videx recommends using the **ANT-GSM-2dB-5M** or **ANT-GSM-2dB-15M** high gain antennas or another suitable GSM antenna with a standard SMA male connector.

## DIALLING INTO THE DIGITAL GSM FROM ANOTHER TELEPHONE

There are three possible outcomes to dialling into the digital GSM intercom depending on the telephone number you are dialling in from and the features setup during programming. The three possible outcomes are shown in the priority function table below and are shown in order of priority. For example, if the number is programmed to automatically activate the relay (**DTO**), this will take priority over the following two options and if the telephone number is stored as a telephone number called from one of the push buttons, this will take priority over the last option.

**Priority Function Table**

FUNCTION	REQUIREMENT	PRIORITY
<b>Dial in to open the Door (DTO).</b> After dialling the GSM number, the relay will activate and the call will be dropped.	The telephone number of the telephone dialling in must be stored as a primary number or one of the divert numbers: <b>STNn</b> , <b>STDn</b> , <b>STEn</b> or <b>STFn</b> . The <b>DTO</b> feature <b>must</b> be enabled (switched ON) for the apartment, also see <b>STOn:O</b> notes on pages 48 - 49 and also see <b>STNn</b> , <b>STDn</b> , <b>STEn</b> , <b>STFn</b> notes on pages 50 - 51. (where n = apt no. 000 - 499).	<b>1st</b>
<b>Dial in to activate a call (live speech, activate relay/ auxiliary AO).</b> After dialling the GSM number, the call will be answered and two beeps will be heard. The speech will then be live.	The telephone number of the telephone dialling in must be stored as a primary number or one of the divert numbers: <b>STNn</b> , <b>STDn</b> , <b>STEn</b> or <b>STFn</b> . The <b>DTO</b> feature <b>must</b> be disabled (switched OFF) for the apartment, also see <b>STOn:O</b> notes on pages 48 - 49 and also see <b>STNn</b> , <b>STDn</b> , <b>STEn</b> , <b>STFn</b> notes on pages 50 - 51. (where n = apt no. 000 - 499).	<b>2nd</b>
<b>Dial in to open the speech from a telephone number not stored in the digital GSM.</b> After dialling the GSM number, the call will be answered and two beeps will be heard. You will then be required to enter the 4 digit code to open the speech.	If neither of the two requirements above are met.	<b>3rd</b>

## Additional User Information

### UNDERSTANDING THE BEEPS

Functions and errors are indicated by beeps from the digital GSM panel. The following will help you understand the different beeps heard and what, if anything, needs to be done in response to the beeps.

BEEP	REASON	SOLUTION
Short beeps at 1 second intervals.	Relay or auxiliary output activated.	None, this is normal.
Single short beep while the system is in standby and not being used.	A valid text message has been received and processed.	None, this is normal.
Two short beeps followed by a long beep. During this time the GSM display will indicate that it is attempting to call an apartment, see <b>Fig.117</b> on page 63.	Call made to a stored apartment number but no actual telephone number stored.	Program a telephone number for the apartment.
Long beep, followed by a short beep while the system is in standby. During this time the GSM will send an error message to the sender, see <b>Fig.131</b> on page 66.	Invalid text message received.	If this has happened when sending one of the programming text messages then check the message for errors. These beeps will also be heard if the 4 digit master code in the text message is incorrect. If you are unsure of the 4 digit code, try resetting it to '1111'; also see notes on resetting the master code back to factory defaults on page 21.
Short beep while the system is in use.	Manually ending a call by pressing the CLEAR button  .	None, this confirms the call has been cancelled. Another call can be placed if required.
Single short beep approx. every 50 seconds after power up. During this time the GSM display will indicate that it is attempting to register with the network, see <b>Fig.36</b> and <b>Fig.37</b> on page 20.	Not registered with a network provider but still trying. Unable to see the SIM card or unable to see the antenna or other unknown registering problem.	Leave it a short while to see if it manages to find the network. If the beeps repeat every 50 seconds or so then try the following: check the SIM card is fitted correctly. Try removing the SIM card, cleaning and fitting again. Try moving the antenna to a better location. Try changing the SIM card to another network provider or try changing the antenna.
<b>PROXIMITY READER (ONBOARD READER OR ART.4850R EXPANSION READER)</b>		
BEEP	REASON	SOLUTION
Successive short beeps lasting for the duration of the relay time ("the door is open" or "the gate is open").	Programmed fob/card presented to the onboard or expansion reader.	None, this is normal.
Single long beep ("invalid code").	Fob/card presented to the onboard or expansion reader that is <b>not</b> programmed.	The fob/card requires programming into the digital GSM (ensuring the onboard reader is enabled).
Single long beep ("invalid code").	Fob/card presented to the onboard or expansion reader <b>is</b> programmed in the digital GSM however the number of bytes to check for maybe incorrect.	Although the fob/card <b>is</b> programmed in the digital GSM try changing the number of bytes to check for to 2 bytes.
No beeps. The onboard reader is unresponsive.	The onboard reader has not been enabled (regardless of whether fobs have or have not been programmed).	Enable the onboard proximity reader.

# User Management

## RECORD SHEET

In order to manage the digital GSM intercom effectively it is recommended that an up to date record sheet is kept for all the programming particularly if there is a high volume of telephone numbers and fob/cards stored in the GSM intercom. This will also be useful if any future changes need to be made. The following table format can be used to record the digital GSM's basic information.

Digital GSM intercom telephone No.	
IMEI number	
Master code (default 1111)	
Master telephone No.	

It is recommended that the table format below be used to record the apartment's details from memory location 0 up to 499, which includes the following information: the primary number (TEL) and three divert numbers (DIV1, DIV2 and DIV3), the apartment number, username, access code, if the dial to open feature is enabled and a timeband number.

MEM. Location	TEL	DIV1	DIV2	DIV3	Apt. No.	Username	Access Code	DTO enabled?	Timeband (0 - 9)
0									
↓	↓	↓	↓	↓	↓	↓	↓	↓	↓
499									

If the proximity reader (onboard reader or Art.4850R expansion reader) is being used it is recommended that the table format below be used to record the proximity fob/card details from memory location 0 up to 1999, which includes the following information: the site code, user code and username.

MEM. Location	Site Code	User Code	Username
0			
↓	↓	↓	↓
1999			

A note of the access control timebands (TBA) should be kept (from 0 to 9), following the table format below:

TIMEBAND NO.	ON TIME	OFF TIME	
Timeband 0	00 : 00	23 : 59	(default)
Timeband 1	:	:	
↓	↓	↓	
Timeband 9	:	:	

A note of the free access timebands (FRE) should be kept (from 0 to 9), following the table format below:

TIMEBAND NO.	ON TIME	OFF TIME	Su	Mo	Tu	We	Th	Fr	Sa	RLY	AO	LAT	MOM
Timeband 0	:	:											
↓	↓	↓											
Timeband 9	:	:											

## USING THE GSMSK PC SOFTWARE TO MANAGE USER INFORMATION

Because of the high volume of user information that may need to be recorded it is possible to use the GSMSK PC software (version 4.0.0.0 or later) to record and save the apartment information as an excel spreadsheet using the 'Export Calls to Excel' feature. The same PC software can also be used to record and save the proximity information as an excel spreadsheet using the 'Export Prox to Excel' feature.

Further information on how to do this can be found in the following technical manual:

- GSMSK\_66251720-EN\_V2-0 (or later).

## MANAGING GSM EVENTS REMOTELY

Users can also remotely monitor events in real-time from the digital GSM using Videx's web browser based events application. These events can then be viewed on any device such as a tablet, smartphone, laptop and PC.

**IMPORTANT NOTE:** The SIM card used in the digital GSM intercom requires a data package to be included in order to send the events to the server. Setup of the system only requires a few short steps and help on this can be found once registered and logged in.

Further details on how to register an online profile for this application can be found on the website: [www.videxevents.co.uk](http://www.videxevents.co.uk)

# Troubleshooting

## SYSTEM CHECKS AND TESTING

The following table can be used to help diagnose any potential issues that may occur during installation and the system checks that can be carried out to help resolve them.

SYMPTOM	TEST
Interference on the speech.	Check the signal strength <b>1111SIG?</b> (if the signal strength is too low the GSM module increases it's power to compensate, causing interference with the speech circuits). Try relocating the antenna or using a more powerful or directional antenna (e.g. high gain antenna).
	Ensure the antenna cables are not running close to the power supply cables or the microphone wires inside the intercom panel.
	Try a different SIM card from a different network service provider as they may have better coverage in that area.
Nothing is shown on the graphical display and it is not illuminated.	Check the power supply has adequate voltage as described earlier in this manual (refer to pages 7 and 19).
	Try a full reset (refer to page 21)
	The digital GSM module may have a fault.
The digital GSM intercom does not respond to SMS messages.	Check the SIM card has an SMS service centre number stored. This will require putting the SIM card into a mobile phone to check. Contact the SIM card provider if you are not sure.
	Check the number you are sending the message to is correct (the number of the SIM card in the digital GSM intercom panel).
	After sending an SMS message to the digital GSM listen for a single short beep from the intercom panel. This will indicate that the message was received and understood. If a long beep is heard it indicates the message was either not understood or the 4 digit master code was incorrect.
	Try resetting the 4 digit master code to 1111 (refer to page 21).
The digital GSM intercom does not respond to SMS messages, but all other functions appear to operate ok, e.g. DTO feature, adjusting speech volumes, releasing the door/gate when button 3 pressed on the phone etc.	This issue can occur on smartphones where the SMS messaging input method is set to UNICODE. Smartphones generally have 3 input methods: GSM alphabet, Automatic and UNICODE. The UNICODE setting is typically used when emoticons/emojis are used in the message so the digital GSM will not recognise text messages that are set to this mode.
	Check that the SMS messaging input method setting on the smartphone is <b>not</b> set up as UNICODE and is set to either GSM alphabet or Automatic. This can usually be done via the settings icon on the smartphone. If you are unsure of how to do this Videx recommend consulting with the user's manual that came with the smartphone or consulting directly with the manufacturer of the smartphone.
The call keeps dropping out.	Increase the call time ( <b>SPT</b> ) of the digital GSM intercom (refer to the ' <b>time settings menu</b> ' programming flowchart on page 34 to program via the keypad and page 51 to program by SMS message).
	Check the signal strength and if necessary, move or change the antenna or try a different SIM card provider.
Speech echoes and feeds back.	Try adjusting the mic and speaker volume via the keypad selecting the ' <b>general settings menu</b> ' on the digital GSM intercom (refer to the programming flowchart page 31).
	Try adjusting the mic and speaker volume using the programmable settings during a call (refer to user command table 1 on page 66).
	Check the microphone is fitted correctly in the intercom panel and the mic is sat correctly in the rubber boot and the mic hole is not blocked in any way.
ERROR message returned in SMS when programming or no SMS returned at all even though a ? was included at the end of the message sent.	<p>Check over the message sent again and compare it with the examples in this manual. Common errors include:</p> <ol style="list-style-type: none"> <li>Using two apostrophe marks side by side instead of ". Note that these look the same in the message. An easy way to see if this is the problem is to move the cursor along in the message and if the cursor can get between the two " then it is not the correct character used.</li> <li>Lower case letters instead of upper case. For example using <b>stn</b> when <b>STN</b> should be used.</li> </ol>

## Troubleshooting

<p>Unable to open the gate/door from the telephone during a call (DTMF tones not being recognised) continued.</p>	<p>If the DTMF tone to release the gate/door (or other DTMF tones shown in the user command table 1 on page 66) does not work then check to see if the <b>ED#</b> function has been enabled:</p> <ol style="list-style-type: none"> <li>1. Send the following SMS command <b>1111ED#?</b> to the digital GSM and wait for a reply confirming the status of this function.</li> <li>2. <b>Note:</b> If the <b>1111EDZ</b> function (also see notes on page 56) is set to 001 (enabled) then when answering the call it will be necessary to first press 0 to accept the call before 3 can be used to operate the gate/door.</li> </ol> <p>Further notes on how to effectively use this function and on the setup of this function can be found on page 56.</p>
	<p>If the DTMF tones are not working reliably then try the following adjustments:</p> <ol style="list-style-type: none"> <li>1. Send the following SMS command <b>1111AT1"AT#DTMFCFG=8,2500,1500"?</b> to the digital GSM and wait for a reply.</li> <li>2. After receiving the reply send the SMS command <b>1111RBT</b> then wait for the digital GSM to reboot.</li> <li>3. After the digital GSM intercom has rebooted test the door opening feature from the telephone during a call.</li> </ol>
	<p>If the first solution still does not resolve the issue then try the following:</p> <ol style="list-style-type: none"> <li>1. Send the following SMS command <b>1111AT1"AT#DTMFCFG=7,2300,1300"?</b> to the digital GSM and wait for a reply.</li> <li>2. After receiving the reply send the SMS command <b>1111RBT</b> then wait for the digital GSM to reboot.</li> <li>3. After the digital GSM intercom has rebooted test the door opening feature from the telephone during a call.</li> </ol>
	<p>If none of the solutions above resolve the problem then please contact Videx technical on tel: <b>0191 224 3174</b> for further assistance. For overseas customers contact Videx customer support on tel: <b>(+39) 0734 631 699</b> for further assistance.</p>

Further guidance can also be found in the 'additional user information' section of this manual on page 68 in the 'understanding the beeps' table.

# General Information

## SOFTWARE REVISION

DATE	SOFTWARE VERSION	REVISION
02/01/17	DG4.0.0 (alpha) / DG3.0.0 (scroll)	Launch of the digital GSM (4812, 4812R).
01/02/17	DG4.0.1/2G (alpha) / DG3.0.1/2G (scroll) DG4.1.1/3G (alpha) / DG3.1.1/3G (scroll)	Firmware update to allow letters to be used during programming of apartment numbers through panel (4812 only). Firmware update, changed deleted fob from 11111111 to 00000000 (4812R).
12/07/17	DG4.0.2/2G (alpha) / DG3.0.2/G (scroll) DG4.1.2/3G (alpha) / DG3.1.2/3G (scroll)	Firmware update: added ED# command (users can setup the need to press # before pressing 3 to release door/gate), Prox and PTE to work while unit still initialising. Moved balance check from ATH routine and placed in end call routine. Add ATH send for every 8.5 mins. Changed DTMF settings to improve DTMF decoding. Added 1111ATn"command"? commands to include DTMF adjustment feature, where n = 1-3. Bug with D0 fixed. Service interval automated message system added. Changed Telit modules CPCUMODE to a higher speed to overcome DTMF issues in Belgium. Added the option of both Door & Gate open messages. Fixed bug with busy, engaged & no answer calls where calls didn't end straight away upon these events. Changed deleted fob from 11111111 to 00000000 (4812).
01/08/17	DG4.0.4/2G (alpha) / DG3.0.3/G (scroll) DG4.1.4/3G (alpha) / DG3.1.3/3G (scroll)	Fixed bug in admin programming menu: display showed 'to call' instead of 'to confirm'.
14/08/17	DG4.0.5/2G (alpha) / DG3.0.4/2G (scroll) DG4.1.5/3G (alpha) / DG3.1.4/3G (scroll)	Update AO trigger to include activation from an access code and proximity fob/card when stored in memory location '000' for code and memory location '0000' for proximity fob/card.
18/09/17	DG4.0.6/2G (alpha) / DG3.0.5/2G (scroll) DG4.1.6/3G (alpha) / DG3.1.5/3G (scroll)	Update general settings menu to include additional languages. Fixed bug in 1111MEMnnn? SMS command where it didn't reply if location was blank. Also end on last divert feature, EOD, included.
24/05/19	DG4.0.7/2G (alpha) / DG3.0.6/2G (scroll) DG4.1.7/3G (alpha) / DG3.1.6/3G (scroll)	Firmware update to include: <ul style="list-style-type: none"> <li>• Requires PC software version 4.x.x.x or later.</li> <li>• Added RS485 proximity reader connectivity (4850R)</li> <li>• Added remote event logging via the <a href="http://www.videxevents.co.uk">www.videxevents.co.uk</a> portal.</li> <li>• Added new SMS commands for programming free access timebands and programming multiple telephone numbers. Added SMS commands ready for new GSM app.</li> <li>• Timebands can now be set for individual days of the week.</li> <li>• New commands –               <ul style="list-style-type: none"> <li>□ STN for programming all 4 number in single SMS.</li> <li>□ 1111FOB"0""12345" – storing a fob in the next free location.</li> <li>□ DEF Delete a fob.</li> <li>□ FRE Free access for any of the outputs (Up to 10 periods).</li> <li>□ FRD Delete all free access periods.</li> </ul> </li> </ul>

## FURTHER READING

Additional programming information using the GSMSK PC software can be found in the following technical manual:

- GSMSK\_66251720-EN\_V2-0 (or later)

Additional setup information for the expansion proximity reader module can be found in the following installation instructions:

- ART.4850R\_66250407-EN\_V1-0 (or later)

Additional information regarding connection to mains supply voltage can be found in the following regulations for UK based customers:

- I.E.E. Wiring Regulations BS7671

For overseas customers please consult the relevant standards of your country.



# Notes

A series of horizontal dashed lines for taking notes.

## Notes

A series of horizontal dashed lines for taking notes.

**ENG DISPOSAL**

In accordance with the Legislative Decree no. 49 of 14 March 2014 "Implementation of the Directive 2012/19/EU on waste electrical and electronic equipment (WEEE)".

The crossed-out bin symbol on the equipment or on the packaging indicates that when the product reaches the end of its lifetime, it must be collected separately from mixed municipal waste. The user must, therefore, dispose of the equipment at the end of its lifetime in the suitable waste collection centres or bring it to the retailer during the purchase of a new equipment of equivalent type at the ratio of one-to-one. Furthermore, the user is allowed to dispose of the WEEEs of very small size (domestic appliances without any external dimension exceeding 25 cm (9.84 inches) for free to the retailers, without any purchase obligation. The correct waste disposal of the WEEEs contributes to their reuse, recycling and recovery and avoids potential negative effects on the environment and human health due to the possible presence of dangerous substances within them.

**ITA SMALTIMENTO**

Ai sensi del Decreto Legislativo 14 marzo 2014, n° 49 "Attuazione della direttiva 2012/19/UE sui rifiuti di apparecchiature elettriche ed elettroniche (RAEE)".

Il simbolo del cassonetto barrato riportato sull'apparecchiatura o sulla sua confezione indica che il prodotto alla fine della propria vita utile deve essere raccolto separatamente dagli altri rifiuti urbani misti. L'utente dovrà, pertanto, conferire l'apparecchiatura giunta a fine vita presso gli idonei centri di raccolta differenziata oppure riconsegnarla al rivenditore al momento dell'acquisto di una nuova apparecchiatura di tipo equivalente, in ragione di uno a uno. L'utente ha, inoltre, la possibilità di conferire gratuitamente presso i distributori, senza alcun obbligo di acquisto, per i RAEE di piccolissime dimensioni (per le apparecchiature di tipo domestico con nessuna dimensione esterna superiore a 25 cm). L'adeguata raccolta differenziata dei RAEE contribuisce al loro riutilizzo, riciclaggio e recupero ed evita potenziali effetti negativi sull'ambiente e sulla salute umana dovuti alla eventuale presenza di sostanze pericolose al loro interno.

**FRA ÉLIMINATION**

Conformément au décret législatif n° 49 du 14 mars 2014 relatif à l'« Application de la directive 2012/19 / UE relative aux déchets d'équipements électriques et électroniques (DEEE) ».

Le symbole de la poubelle barrée sur l'équipement ou sur son emballage indique que le produit en fin de vie utile doit être collecté séparément des autres déchets municipaux en mélange. L'utilisateur doit donc remettre l'équipement en fin de vie aux centres de collecte appropriés ou le restituer au revendeur lors de l'achat d'un nouveau type d'équipement équivalent, dans le rapport de un à un. De plus, l'utilisateur a la possibilité de conférer gratuitement aux distributeurs, sans aucune obligation d'achat, de très petits DEEE (pour les appareils ménagers sans dimensions extérieures supérieures à 25 cm). La collecte séparée adéquate des DEEE contribue à leur réutilisation, leur recyclage et leur valorisation et évite les éventuels effets négatifs sur l'environnement et la santé humaine en raison de la présence possible de substances dangereuses dans ceux-ci.

**SPA ELIMINACIÓN**

De conformidad con el Decreto legislativo n. 49 de 14 de marzo 2014 "Aplicación de la Directiva 2012/19/UE relativa a residuos de aparatos eléctricos y electrónicos (RAEE)".

El símbolo del contenedor tachado indicado sobre los aparatos o sobre los embalajes señala que el producto al final de su vida útil debe ser recogido separadamente de otros residuos municipales mezclados. Por tanto, el usuario deberá conferir los aparatos al final de su vida útil en los apropiados centros de recogida selectiva o devolverlos al revendedor al momento de la compra de nuevos aparatos equivalentes, en una relación de uno a uno. Además, el usuario tiene la posibilidad de entregar sin cargo a los distribuidores, sin ninguna obligación de compra, los RAEEs muy pequeños (para electrodomésticos sin dimensiones externas superiores a 25 cm).

La recogida selectiva apropiada de los RAEEs contribuye a su reutilización, reciclaje y valorización y evita potenciales impactos negativos sobre el medio ambiente y la salud humana debidos a la posible presencia de sustancias peligrosas dentro de ellos.

**NLD VERWIJDERING**

In overeenstemming met het Wetsbesluit nr. 49 van 14 maart 2015 "Implementatie van de Richtlijn 2012/19/EU inzake afgedankte elektrische en elektronische apparaten (AEEA)".

Het doorgekruiste vuilnisbaksymbool op het apparaat of de verpakking geeft aan dat het product aan het einde van zijn levensduur niet samen met het gewone huisvuil weggegooid mag worden. De gebruiker moet het apparaat aan het einde van zijn levensduur inleveren bij een gepast inzamelpunt of de winkel waar hij een nieuw apparaat van een gelijksoortig type zal kopen. De gebruiker kan tevens AEEA's van een zeer klein formaat (huishoudapparaten met een buitenafmeting kleiner dan 25 cm (9,84 inch)) gratis en zonder enige aankoopverplichting bij handelaars inleveren. Een juiste verwijdering van AEEA's draagt bij tot hergebruik, recycling en terugwinning, en voorkomt potentiële negatieve effecten op het milieu en de menselijke gezondheid door de mogelijke aanwezigheid van gevaarlijke stoffen.

<b>MANUFACTURER</b> <b>FABBRICANTE</b> <b>FABRICANT</b> <b>FABRICANTE</b> <b>FABRIKANT</b> الشركة المصنعة	<b>VIDEX ELECTRONICS S.P.A.</b> Via del Lavoro, 1 63846 Monte Giberto (FM) Italy Tel (+39) 0734 631669 Fax (+39) 0734 632475 www.videx.it - info@videx.it	
<b>CUSTOMER SUPPORT</b> <b>SUPPORTO CLIENTI</b> <b>SUPPORTS CLIENTS</b> <b>ATENCIÓN AL CLIENTE</b> <b>KLANTENDIENST</b> خدمة العملاء	<b>VIDEX ELECTRONICS S.P.A.</b> www.videx.it - technical@videx.it Tel: +39 0734-631669 Fax: +39 0734-632475	UK Customers only: <b>VIDEX SECURITY LTD</b> www.videxuk.com Tech Line: 0191 224 3174 Fax: 0191 224 1559

*Main UK office:***VIDEX SECURITY LTD**

1 Osprey Trinity Park  
Trinity Way  
LONDON E4 8TD  
Phone: (+44) 0870 300 1240  
Fax: (+44) 020 8523 5825  
www.videxuk.com  
marketing@videxuk.com

*Northern UK office:***VIDEX SECURITY LTD**

Unit 4-7  
Chillingham Industrial Estate  
Chapman Street  
NEWCASTLE UPON TYNE - NE6 2XX  
Tech Line: (+44) 0191 224 3174  
Phone: (+44) 0870 300 1240  
Fax: (+44) 0191 224 1559

*Greece office:***VIDEX HELLAS Electronics**

48 Filolaou Str.  
11633 ATHENS  
Phone: (+30) 210 7521028  
(+30) 210 7521998  
Fax: (+30) 210 7560712  
www.videx.gr  
videx@videx.gr

*Danish office:***VIDEX DANMARK**

Hammershusgade 15  
DK-2100 COPENHAGEN  
Phone: (+45) 39 29 80 00  
Fax: (+45) 39 27 77 75  
www.videx.dk  
videx@videx.dk

*Benelux office:***NESTOR COMPANY NV**

E3 laan, 93  
B-9800 Deinze  
Phone: (+32) 9 380 40 20  
Fax: (+32) 9 380 40 25  
www.videx.be  
info@videx.be

*Dutch office:***NESTOR COMPANY BV**

Business Center Twente (BCT)  
Grotestraat, 64  
NL-7622 GM Borne  
www.videxintercom.nl  
info@videxintercom.nl



The product is CE marked demonstrating its conformity and is for distribution within all member states of the EU with no restrictions. This product follows the provisions of the European Directives 2014/30/EU (EMC); 2014/35/EU (LVD); 2011/65/EU (RoHS); CE marking 93/68/EEC.

Le produit est marqué CE à preuve de sa conformité et peut être distribué librement à l'intérieur des pays membres de l'union européenne UE. Ce produit est conforme aux directives européennes 2014/30/EU (EMC); 2014/35/EU (LVD); 2011/65/EU (RoHS); marquage CE 93/68/EEC.

Het product heeft de CE-markering om de conformiteit ervan aan te tonen en is bestemd voor distributie binnen de lidstaten van de EU zonder beperkingen. Dit product volgt de bepalingen van de Europese Richtlijnen 2014/30/EU (EMC); 2014/35/EU (LVD); 2011/65/EU (RoHS); CE-markering 93/68/EEC.

Il prodotto è marchiato CE a dimostrazione della sua conformità e può essere distribuito liberamente all'interno dei paesi membri dell'Unione Europea UE. Questo prodotto è conforme alle direttive Europee: 2014/30/UE (EMC); 2014/35/UE (LVD); 2011/65/UE (RoHS); marcatura CE 93/68/EEC.

El producto lleva la marca CE que demuestra su conformidad y puede ser distribuido en todos los estados miembros de la unión europea UE. Este producto cumple con las Directivas Europeas 2014/30/EU (EMC); 2014/35/EU (LVD); 2011/65/EU (RoHS); marca CE 93/68/EEC.

يحمل المنتج علامة التوافق الأوروبي CE لإظهار توافقه مع المواصفات ذات الصلة وإمكانية توزيعه في كافة دول الاتحاد الأوروبي بدون أية قيود. يلبّي هذا المنتج جميع متطلبات التوجيهات الأوروبية 2014/30/UE (EMC); 2014/35/UE (LVD); 2011/65/UE (RoHS); علامة المطابقة للمواصفات الأوروبية 93/68/EEC.



66251750-EN