



RB3 R868, RB3 T868, RB3 T868W & RB3 R868W

User Manual

EN

Table of contents

Important safety instructions	3
Use of the equipment	3
Introduction	4
Operating	4
Receiver RB3 R868	5
Transmitter RB3 T868	6
Assembly and installation	7
Installation of the equipment	7
Connecting the receiver to the control panel	9
<i>Adjustment of the receiver / Operating modes</i>	10
<i>ON/WORK mode</i>	11
<i>ATEST signal</i>	12
Connecting the safety edge to the transmitter	13
Programming	15
Mode 1: Safety edge connected to IN1 activates R1	16
Mode 2: Safety edge connected to IN1 activates R2	17
Mode 3: Safety edge connected to IN1 activates R1 and R2	18
Mode 4: Safety edge connected to IN1 activates R1 and safety edge connected to IN2 activates R2	19
Checking and maintenance	20
Does the equipment work properly?	20
Total reset	20
CHECK function	21
Troubleshooting	22
Batteries	23
Technical data	24
Notes	26
Regulatory Data	28
UK Declaration of conformity	28

Important safety instructions



Disconnect the power supply whenever you proceed to the installation or repair of the equipment.

In compliance with the European Low Voltage Directive, we inform you of the following requirements:

- When the devices remain permanently connected, an easily accessible connecting device must be incorporated into the wiring.
- This system must only be installed by qualified professionals that have with automated garage doors and knowledge of the relevant European standards.
- The user instructions for this device must always be in the user's possession.
- The operating frequency of the receiver does not interfere in any way with the 868 MHz remote control systems.

Use of the equipment

This device is designed for applications with an automated garage door. It is not guaranteed for the direct activation of devices other than those specified. The manufacturer reserves the right to change the device specifications without warning.

More tips, interactive demos and online videos.



Introduction

Operating

The RadioBand system is designed for Domestic, Commercial and Industrial door and gate applications where a safety edge is used.

The system provides a wireless system replacing spiral cables or energy chain systems to provide the safety signal to the door or gate control panel.

The receiver continuously monitors the status of transmitters connected to it. The system performs a complete test of the equipment, including radio communication, every 7 seconds.

With the system you can support 8,2 KOhm safety edges and also optical low power systems. Additionally you can connect slack ropes and wicket doors in the 8k2 input. The signal will be transferred by radio.

When an obstacle is detected, the RadioBand system turns its output in a safety state, changing the state of the receiver relay.

Up to three transmitters per output can be connected to the receiver. There are two outputs on each receiver that can be connected to the control panel as 8k2 or NC (normally closed) contact.

The system complies with EN ISO 13849-1:2015, category 2, PLd. Certified by TÜV NORD CERT GmbH.

Receiver RB3 R868



Compatible equipment: RB3 T868,
RB3 TGL868 and RB3 TGLA868

LED	ON	OFF
R1	Safety edge on relay 1 activated or not connected	Normal use
R2	Safety edge on relay 2 activated or not connected	
R3	Sw3 ON - Low battery indicator SW3 OFF - Same as R1 / R2	
CHECK	See signal coverage table (page 19)	

CHECK BUTTON
Check system operation

LEDS

PROGRAMMING BUTTON
Program new transmitters

MR JUMPER
Reset transmitters in memory

OPTION SELECTOR

SW	FUNCTION	ON	OFF
SW 1	Interference	7s	265ms
SW 2	Operating mode	ON	WORK
SW 3	R3	Low battery	R3=R1/R2
SW 4	ATEST Polarity	12/24V 0V	12/24V 0V

ATEST INPUT

12/24V AC/DC 5 mA input for testing the system (SW4) and / or activation of the safety edge (SW2)

R3 OUTPUT

Low battery indication or active element output (SW3)

12/24V AC/DC

Power supply
(9-35V DC,
8-28V AC)

R1 / R2 OUTPUTS

Relay outputs to inform the control panel of the state of the safety edge, normally closed contact (CS) and 8k2 (BS) for each relay

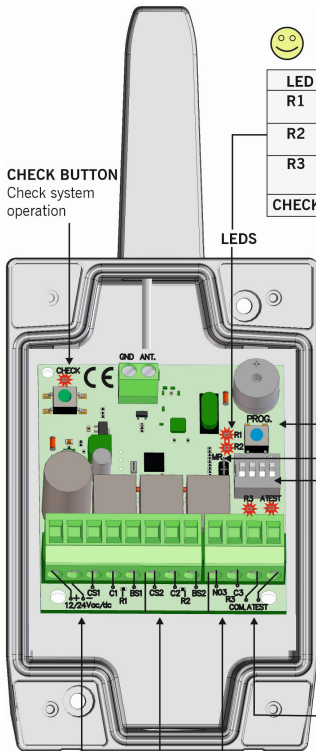

Transmitter RB3 T868

IN1 AND IN2 INPUTS

Connection of up to 2 safety edges

PROGRAMMING BUTTON

Program the transmitter to the receiver

BATTERY CONNECTOR

Connect the batteries for operation

!
Do not carry the equipment with batteries connected

BATTERIES 2X3,6Vdc (ER14505 AA Type)

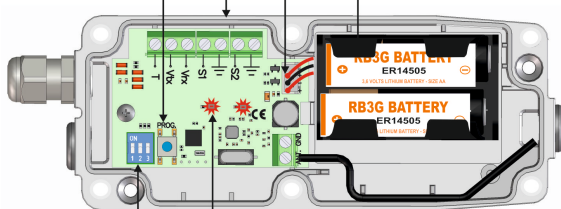

LEDs

IN1 and IN2 safety edge state indicators

LED input status

OFF	Safety edge well connected and working properly
ON	Safety edge pressed or not connected
Flash	Input not programmed / or inhibited if WORK mode activated

OPTION SELECTOR

IN 1	SW 1	SW 2
Optical safety edge always activated (OSE-S7502B and OSE-S7502)	OFF	OFF
Standard optical safety edge	ON	OFF
8k2 resistive safety edge	OFF	ON
NC contact*	ON	ON

IN 2	SW 3
NC contact*	ON
8k2 resistive safety edge	OFF

* Note: In order to comply with the EN 12453:2017 safety standard, NC contact input cannot be used to connect safety devices.

Assembly and installation

Installation of the equipment

RECEIVER

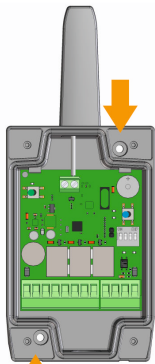

Ø Wire
5,0 - 7,0 mm



TRANSMITTER

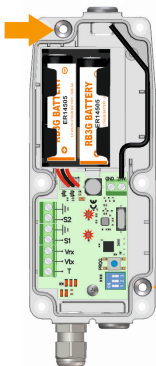

Fixing holes.
Do not drill the
device.
Any holes made by
installer will break
JCM warranty terms.



Glands must be installed to ensure
IP65.
Replace glands for caps on the
cable entrier that are not used.

Install the devices in the
way that the cable outlet
is at the bottom.
Ensure that caps are well
tightened.



Installation advices

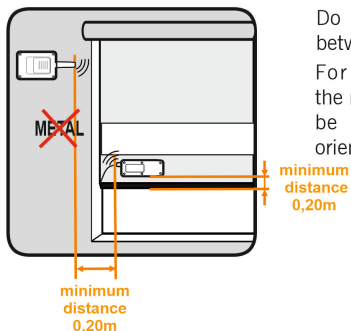

Do not place metal surfaces between transmitter and receiver.
For maximum range, both the receiver and transmitters must be installed with the same orientation (vertical or horizontal).

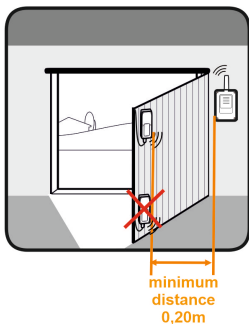

Do not fit the device at ground level.

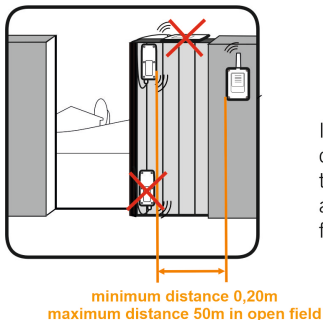

In installation likely to have communication cuts between the transmitter and the receiver, the antenna must stand vertically from the hole in the gland.

In some installations where the communication cuts are frequent, a 868MHz antenna extension should be installed.

Install the external antenna and its cable in a place where they are protected against damage and vibration, and where no obstacles are expected between antennas.



Connecting the receiver to the control panel

Connecting the safety outputs to control panel.

Example: connection to control panel with safety contact / STOP input

Safety edge state	R1 state	R1 LED
Standby / No detecting collision	Closed	Off
Active / Detecting collision	Opened	On

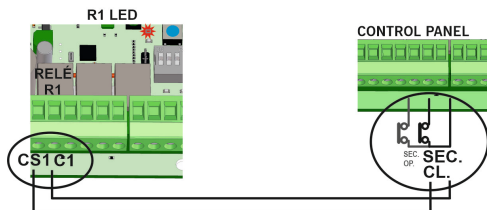

Example: connection to control panel with input for safety edge 8k2

Safety edge state	R1 state	R1 LED
Standby / No detecting collision	8,2k Ω	Apagado
Active / Detecting collision	0k Ω	Encendido

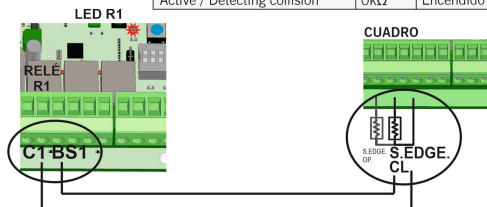

The equipment can be connected to the control panel with input for safety edge 8k2 or directly into a safety input normally closed contact as if it were a photocell or stop signal.

This connectivity exists for R1 and R2 outputs.

Adjustment of the receiver / Operating modes



- ↑ ON Any change in the configuration of the switches needs a reprogramming of the system (see "Programming").
- ↓ OFF

Interference detector

- ↑ 7 s The equipment is switched to safety state after 7s.
- SW1 ↓ 265 ms The equipment is switched to safety state after 265ms.

Operating mode with optical safety edges

- ↑ ON In ON mode, only "always on" optical safety edges (OSE-S7502B and OSE-S7502) are permitted, as the optical element always is on.
- SW2 ↓ WORK In WORK mode, the optical elements are OFF meanwhile the ATEST signal is active. So it is necessary to disconnect this ATEST signal during the door movement.

With resistive or mechanical safety edges, the selector does not work because it is not necessary to activate the sensors.

R3 function

- ↑ Low battery In low battery indication mode, the relay contact is closed when any of the transmitters has an insufficient level of battery.
- SW3 ↓ Alarm In ALARM mode, the relay contact is closed to indicate that any of the safety edges stored in the receiver are active.

ATEST signal polarity (depends on the control panel)

SW4	↑ Negative	ATEST negative: ATEST signal is a fixed 12 or 24V signal that the control panel sets to 0V to make the system check.
	↓ Positive	ATEST positive: ATEST signal is disconnected and when the control panel makes a testing gives a 12 or 24V signal.

In case of operating without ATEST signal, it is necessary to work in ATEST positive way. In order to comply with the EN ISO 13849-1: 2015 safety standard, you must connect this signal to test the system.

ON/WORK mode

The operating mode is selected by the SW2 of the receiver. This selector is necessary when working with optical safety edges. All transmitters in the receiver work in the same way. **It will be necessary to reset the receiver when changing the operating mode with transmitters already memorized.**

With **standard optical safety edges**, WORK mode must be used due to high consumption of the optical elements.

With OSE-S7502B and OSE-S7502 **"always on" optical safety edges**, both modes are allowed. In ON mode, the system becomes universal for any control panel. In WORK mode the battery life is maximized thanks to the shutdown of the optical elements.

ATEST signal

In order to comply with EN ISO 13849-1: 2015 safety standard, a signal to test the system before each door cycle must be connected to the control panel.

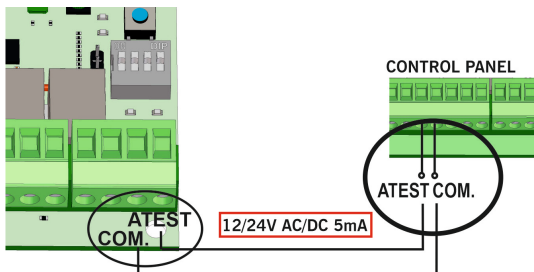

ON MODE

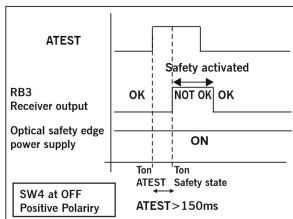

WORK MODE

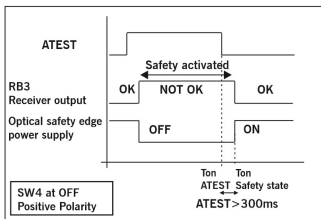

When working with optical safety edges, in ON mode, only OSE-S7502B and OSE-S7502 are allowed as they are kept always active. The radio communication is tested every 7 seconds.

In WORK mode, the ATEST signal is used to power up and down the optical safety edges. The radio communication is tested as in ON mode and when the optical elements are powered up and down.

Connecting the safety edge to the transmitter

Connection examples

8k2 RESISTIVE SAFETY EDGE / MECHANICAL OR CONTACT DEVICES

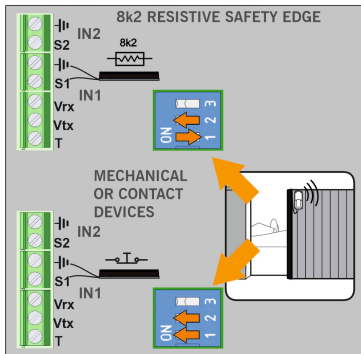

IMPORTANT:

The position of the selector must correspond to the type of safety edge connected.

IN 2 only supports 8k2 resistive safety devices and mechanical / contact devices. The selector 3 is not applicable if nothing is connected to IN2.

OSE-S7502 "ALWAYS ON" OPTICAL SAFETY EDGE

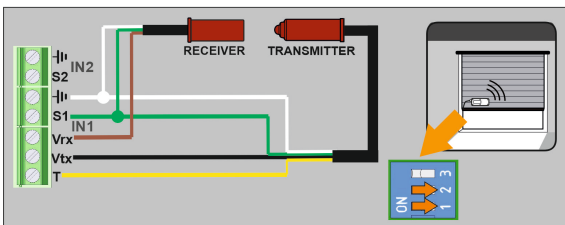

OSE-S7502B "ALWAYS ON" OPTICAL SAFETY EDGE

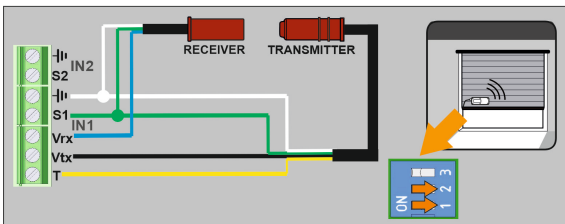

STANDARD OPTICAL SAFETY EDGE (Only used with ATEST function)

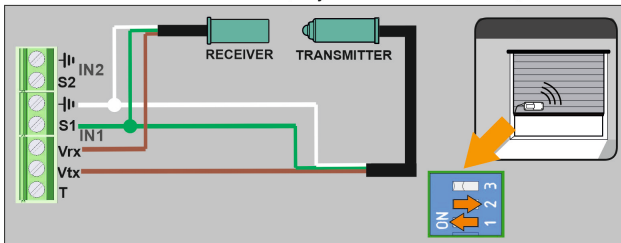

OSE-S7502B "ALWAYS ON" OPTICAL SAFETY EDGE AND WICKET DOOR CONTACT

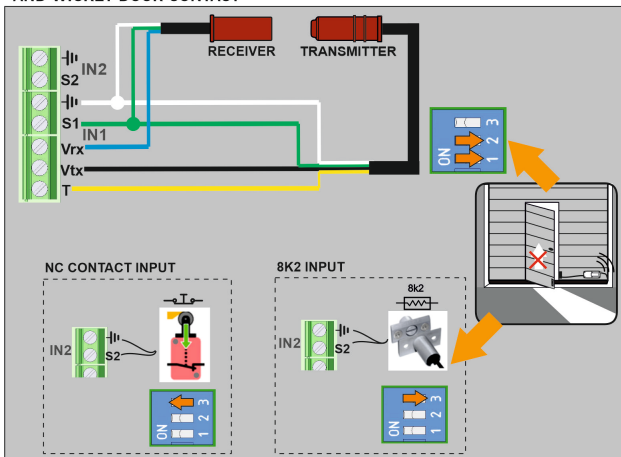

Programming

- Working with one safety edge, it must be connected to IN1 of the transmitter. IN2 does not work. This band can work on R1 (mode 1) or R2 (mode 2) or simultaneously on the 2 relays (mode 3).
- Working with two safety edges (mode 4), the safety edge connected to IN1 act on R1 and the safety edge IN2 connected on R2. In IN2 only mechanical band / contact or 8k2 band is allowed..

Before programming, place the options selectors at the desired position. Any subsequent change will require a receiver reset and reprogramming.

Press the PROG button and hold it until the desired mode is selected. LED's for R1 & R2 will flash in sequence to select the correct operation mode.

There are **four programming modes**, depending on the inputs you wish to use of the transmitter and the outputs required to activate on the receiver.

Mode

- 1 **IN1 → R1**: Safety edge in IN1 on transmitter activates R1 on receiver
- 2 **IN1 → R2**: Safety edge in IN1 on transmitter activates R2 on receiver
- 3 **IN1 → R1 + R2**: Safety edge in IN1 on transmitter activates R1 and R2 on receiver
- 4 **IN1 → R1 and IN2 → R2**: Safety edge in IN1 on transmitter activates R1 on receiver and safety edge in IN2 on transmitter activates R2 on receiver

The equipment remains in programming mode during 60s before programming the first transmitter, and then 20s more for each of the following transmitters.

Mode 1: Safety edge connected to IN1 activates R1

Safety edge connected in IN1 will activate R1.

Employed receiver memory = 1 transmitter

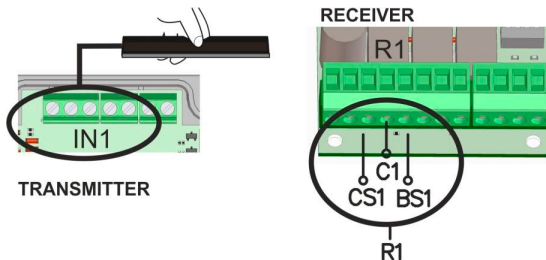

Programming sequence:

- Press PROG button on the receiver (1) until R1 LED lights (2).
- Press PROG button on the transmitter (3).
- A beep will be heard on the receiver indicating the transmitter is properly programmed (4).

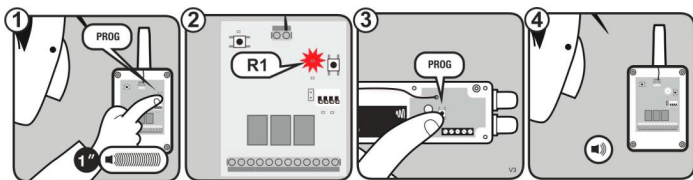

- To exit programming mode, wait for 20 seconds or press PROG button on the receiver. Two beeps will be heard.

Mode 2: Safety edge connected to IN1 activates R2

Safety edge connected in IN1 will activate R2.

Employed receiver memory = 1 transmitter

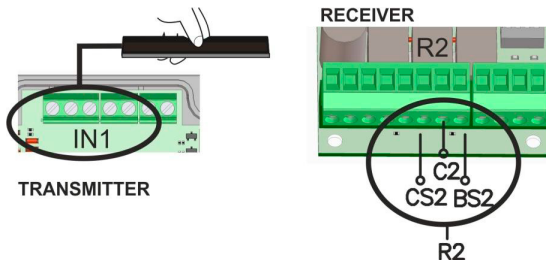

Programming sequence:

- Press PROG button on the receiver (1) until R2 LED lights (2).
- Press PROG button on the transmitter (3).
- A beep will be heard on the receiver indicating the transmitter is properly programmed (4).

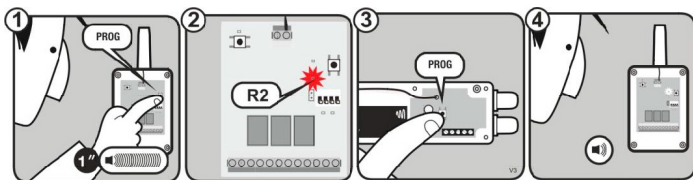

- To exit programming mode, wait for 20 seconds or press PROG button on the receiver. Two beeps will be heard.

Mode 3: Safety edge connected to IN1 activates R1 and R2

Safety edge connected in IN1 will activate R1 and R2.

Employed receiver memory = 2 transmitters

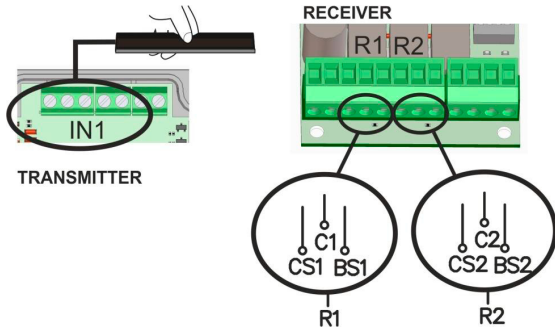

Programming sequence:

- Press PROG button on the receiver (1) until R1 LED and R2 LED light (2).
- Press PROG button on the transmitter (3).
- A beep will be heard on the receiver indicating the transmitter is properly programmed (4).

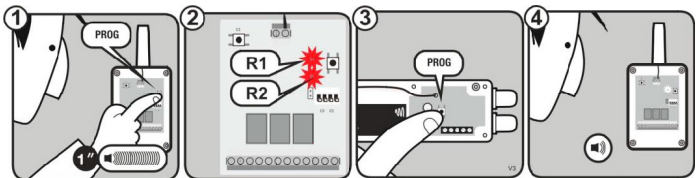

- To exit programming mode, wait for 20 seconds or press PROG button on the receiver. Two beeps will be heard.

Mode 4: Safety edge connected to IN1 activates R1 and safety edge connected to IN2 activates R2

Safety edge connected in IN1 will activate R1 and IN2 will activate R2.

Employed receiver memory = 2 transmitters

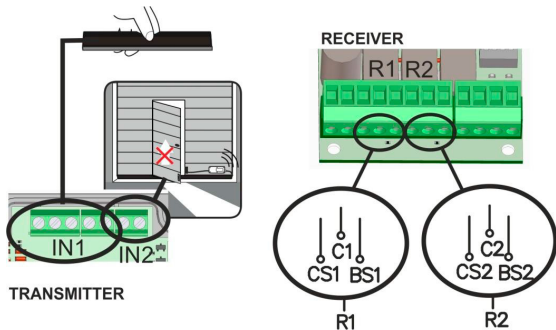

Programming sequence:

- Press PROG button on the receiver (1) until R1 LED and R2 LED flash (2).
- Press PROG button on the transmitter (3).
- A beep will be heard on the receiver indicating the transmitter is properly programmed (4).

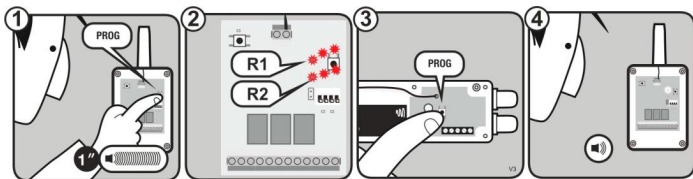

- To exit programming mode, wait for 20 seconds or press PROG button on the receiver. Two beeps will be heard.

Checking and maintenance

Does the equipment work properly?

Once the safety edge is wired and programmed into the receiver, R1 and / or R2 (according to programming mode) is at standby state (off), also IN1 and IN2 at the transmitter.

If the safety edge has been programmed in R1 and R1 LED is at ON, check that the safety edge is not pushed/detecting (IN1 LED at ON on the transmitter) or it is not properly configured (IN1 LED flashing on the transmitter). If IN1 LED is at OFF and R1 LED is at ON, check status of other transmitters memorized.

The IN1 and IN2 LEDs of the transmitter will pass to battery saving mode (off) 5 minutes after pressing PROG on the transmitter. They can re-awaken again pressing the PROG button on the transmitter.

If there is no safety edge programmed in R1 and / or R2, it will be in safety mode (opened and LED at ON)

If R1 / R2 LEDs are at OFF, but the door does not move, check that the wiring to the control panel is made correctly as safety contact or 8k2 input resistive safety edge.

Total reset

- Press PROG button on the receiver (1) until the R1 LED lights on (2).
- Keep the programming PROG button pressed down and make a bridge with the "MR" reset jumper (3).
- The receiver will emit 10 warning sound signals (3), and then more at a faster frequency, indicating that the operation has been carried out (4).

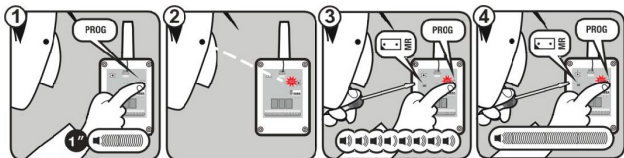

- To exit programming mode, wait for 20 seconds or press PROG button on the receiver. Two beeps will be heard.











CHECK function

Ideal to know the radio coverage of the installation.

Press the receiver's CHECK button for at least 1 second to enter check mode. The indicator light will come on and four beeps will be heard.

Perform a complete door opening and closing manoeuvre. During the system check a beep will be heard every 1,5 seconds. If you have not heard any other acoustic signal at the end of the manoeuvre, the system works properly. If during the verification, the communication with a transmitter fails or the communication is poor, the receiver emits three consecutive beeps indicating that an error occurred.

Press all the safety edges installed to detect which one has failed.

	N° FLASHES CHECK LED	SIGNAL COVERAGE	RESULT OF CHECK
		Very weak	Safety edge failure
		Weak	Ok
		Normal	Ok
		Good	Ok
		Very good	Ok

Low signal coverage increases battery consumption.

To exit Check mode, press the CHECK button or wait 5 minutes. On exiting check mode, seven consecutive beeps will be heard and the indicator light will flash continuously in case of failure.

It is recommended to perform a CHECK function at the end of the installation process to ensure a proper system operation.

Troubleshooting

Press the PROG button to display the status of the LEDs on the transmitter RB3 T

RB3 R		RB3 T		MESSAGE/ERROR	SOLUTION
R1/R2 LED	A TEST LED	IN1/IN2 LED			
				Detection of the safety edge	Verify that the IN1/IN2 LED of the RB3 T is at ON when you press PROG button of RB3 T, to check the correct operation.
				Receiver with another transmitter in memory	Check the IN1 / IN2 state of all RB3 T installed. RESET memory and reprogram to ensure not having other transmitters in memory
				Communication failure between RB3 R and RB3 T	Verify the radio signal with the CHECK function
				The safety edge is not detected correctly (not connected or not programmed) or the position of the selector is incorrect	Reset the system. Connect correctly, check selector or program the safety edge transmitter into the receiver
				RB3 T low battery or communication loss between equipments	Verify the batteries of the transmitter and / or presence of interferences (CHECK function)
				RB3 receiver is in WORK mode waiting for a TEST signal	---
				Check function. See coverage and signal quality table	---
---		---		Receiver memory full. Indication when trying to memorize a new transmitter	Reset the system and reprogram the equipment. Maximum 6 safety edges per receiver (3 per relay)
---		---		Change of operating mode in the RB3 R with transmitters already memorized	Reset the system, change SW2 on the receiver to the desired position and reprogram the equipments
---		---			

Batteries

Storage

- Store the lithium cells in a cool, dry and ventilated area far from fires and heating sources.
- It is recommended the use of a non-combustible structure and keep adequate clearance between walls and batteries.
- The maximum temperature suggested for the storage is +30°C.
- Higher temperatures are allowed but cause an increase in the self discharge of the battery and speed up the process of passivation.
- In any case, never go over 100°C, as the batteries can break and cause a leakage.
- Arrange adequate protections to avoid possible damages to the batteries.
- Keep the batteries in their original packages until they are used.
- Do not expose the batteries directly to the sun light.
- Do not put a higher number of cartons one on another (respect what indicated).
- If in the same place are storage batteries with a total capacity >50,000Ah, it is suggested to install an alarm for smoke and gas.

Usage

- If the battery is integral, store and handle with care (it is suggested to handle the batteries in a ventilated place, do not smoke, eat or drink during the assembly).
- Do not expose at temperature higher than 100°C (it is recommended <85°C).
- Avoid short circuit, crush, and exposition to heat sources.
- Do not disassemble the batteries or the battery packs, do not throw them in the fire, do not perforate them, do not overheat or wet them.
- Material to avoid: water, oxidizing agents, alkalis.



Before disposing of the equipment, remove the batteries and dispose of them at a proper place of disposal.

Technical data

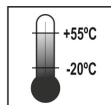
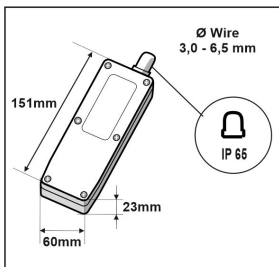
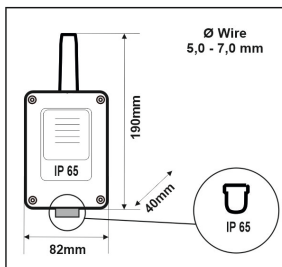

**Glands must be installed to ensure IP65.
Replace glands for caps on the cable entries that are not used.**

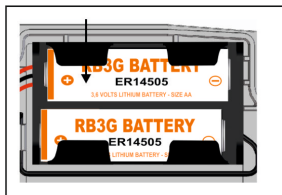

Battery life time: 2 years approximately.
With standard low power opto safety edges, the life time will depend on the working mode and the number of manoeuvres per day.
Do not mix new and old batteries.

	RB3 R868	RB3 T868
Frequency	Multifrequency system 868 MHz auto-adjustable (Channel 1: 868,700 -869,200MHz, Channel 2: 868,000 -868,600MHz; Channel 3: 869,400 - 869,650MHz; Channel 4: 869,400 -869,650MHz)	
Memory	6 transmitters (3 on relay 1, 3 on relay 2)	---
Operating consumption	Max 255mA	12mA
Radiated power	< 25mW	
Minimum / Maximum range (in open field)	50 m	
Reaction time (typical)	35ms	
Maximum reaction time when interferences (SW1=OFF)	265ms	
Compatible equipments	RB3 T868, RB3 TGL868 & RB3 TGLA868	RB3 R868 & RSEC3

The manufacturer reserves the right to change the specification of the equipment without prior warning.

Notes

Notes

Regulatory Data

UK Declaration of conformity

JCM TECHNOLOGIES, S.A. hereby declares that the product **RB3 R868, RB3 T868, RB3 T868W & RB3 R868W** complies with the relevant fundamental requirements of the Radio Equipment Regulations 2017, as well as with the Supply of Machinery (Safety) Regulations 2008 whenever its usage is foreseen; and with the RoHS Regulations 2012.

EU Declaration of conformity

JCM TECHNOLOGIES, S.A. hereby declares that the product **RB3 R868, RB3 T868, RB3 T868W & RB3 R868W** complies with the relevant fundamental requirements of the RED Directive 2014/53/EU, as well as with the Machine Directive 2006/42/EC whenever its usage is foreseen; and with the 2011/65/EU RoHS Directive.

See website <https://www.jcm-tech.com/declarations/>

JCM TECHNOLOGIES, S.A.
C/COSTA D'EN PARATGE, 6B
08500 VIC (BARCELONA)
SPAIN

In order to comply with the EN 12978:2003+A1:2009 product standard and assure the correct operation of the system, it is mandatory to follow the instructions below, to avoid serious dangerous to persons.

If the door cycle is smaller than 7s, the system must be used only in **WORK** mode.

The system complies with EN ISO 13849-1:2015, category 2, PLd. Certified by TÜV NORD CERT GmbH.



UM_3201471_RB3S SYSTEM_EN_Rev01